

Catalogue 2020/2021



Mesan Electric, is proud to be the first manufacturer of visual and audible warning lights in Turkey. In addition to our corporate culture, which has been established for 46 years, our devoted and passionate working principles have enabled us to establish a strong bond with our customers from all over the world. The family company **Mesan** has always aimed and succeeded in providing reliable, rational, standards-compliant, innovative and economical products to the whole industry and general applications. We are determined to serve occupational health and safety, environmental safety, loss of time and property.











Our products, which are the result of our engineering and project studies, are produced exclusively for the customer and the industry, taking into account customer needs and demands.

We always contribute the market in the first place. We produced the first aircraft warning light, the first Electronic Siren, the first warning lamp in Turkey and many of the models has patents and utility models.

Regular quality control and test stages, long warranty duration are at the forefront in the production of our signal products. We do on time shipments with our huge stock and provide services to our customers with technical support after sales. Turkey's first and only TSE certified signal products. It offered its customers 800,000 light sirens, 5,000 aircraft warning lights and hundreds of thousands of buzzers.



IP	First Digit - SOLIDS	Second Digit - LIQUIDS
IP33	Protected from tools and wires greater than 2.5 millimeters.	Protected from water spray less than 60 degrees from vertical.
IP44	Protected from tools and small wires greater than 1 millimeter.	Protected from water spray from any direction.
IP54	Protected from limited dust ingress.	Protected from water spray from any direction.
IP55	Protected from limited dust ingress.	Protected from low pressure water jets from any direction.
IP65	Protected from total dust ingress.	Protected from low pressure water jets from any direction.
IP66	Protected from total dust ingress.	Protected from high pressure water jets from any direction.
IP67	Protected from total dust ingress.	Protected from immersion between 15 centimeters and 1 meter in depth.
IP68	Protected from total dust ingress.	Protected from long term immersion up to a specified pressure.

-  120dB Volume in decibels
-  43 Number of possible tones
-  +60°C / -20°C Working temperature in °C, highest and lowest rating
-  IP65 Protection rating according to EN 60 529
-  Power supplied by solar energy
-  XENON STROBE Xenon Flashing Light
-  LED LED Light
-  BULB Incandescent light bulb
-  Products bearing the CE mark conform to current EU regulations and are tested for adherence to EMC codes.
-  Devices bearing this mark and number are authorised for use in hazardous areas. Ex devices guarantee a high level of resistance to extreme conditions.
-  ICAO compliance or ICAO compliance certificate



Play Sound
www.mesanelektrik.com

- In this catalogue, there are some models which order no's are written. If not please check related [how to order](#) section to find the product order no. Choose model number, color and voltages. Write them in the order which section shows.
- If you need to search any product on our website please only type [model](#) number on search bar. Do not type MS, color code or voltages. All of product prices could be found on our website.

HOW TO ORDER

MS 83013 . 1 . 12VDC Order no:
MS 83013.1.12VDC

[MODEL] ① - red [VOLTAGE]

 ② - green

 ③ - amber

 ④ - white

 ⑤ - blue

Signal Towers	
Warning Beacons 300 Series	4
1 Tier Signal Towers	5
2 Tiers Signal Towers	6
3 Tiers Signal Towers	7
4 Tiers Signal Towers	8
5 Tiers Signal Towers	9
Audible Signal Devices	
Motor Sirens	10
Buzzers	11
Panel Mount Buzzers	12
Electronic Sirens	13-15
Multicolor RGB Warning Lights	16-17
Optical and Audible Beacons	18-27
Warning Beacons	
Warning Beacons 300 Series	27
Ø50mm Compact Beacons	28
250 Series & M30 Panel Mount Beacons	29
700 Series Ø90 Warning Beacons	30
600 Series Ø110 Warning Beacons	31
800 Series Ø110 Warning Beacons	32
900 Series Ø135 Warning Beacons	33
8000 Series Ø140 Warning Beacons	34
Heavy Duty Warning Beacons and Sirens	35
Forklift Safety Lights	36
Emergency Signal Devices	37
Solar Warning Beacons	38
Warning Beacons with Battery	39
Traffic Lights	40-41
Obstruction Lights	42-45
Helipad Lights	46
Explosion Proof Lightings	47

Warning Beacons Ø70mm 300 Series

		With buzzer	Mounting	Light	Buzzer	Model
 70x100x115	 70x100x115		Bulb Permanent	-	300	
				Buzzer	312	
			Bulb Blinking	-	352	
				Buzzer	314	
Xenon Strobe	-	354				
	Buzzer	315				
LED Multifunction	-	350				
	Buzzer	313				
 70x70x200	 70x70x281		Bulb Permanent	-	301	
				Buzzer	316	
			Bulb Blinking	-	360	
				Buzzer	318	
Xenon Strobe	-	361				
	Buzzer	319				
LED Multifunction	-	362				
	Buzzer	317				
 70x100x166	 70x100x250		Bulb Permanent	-	302	
				Buzzer	320	
			Bulb Blinking	-	366	
				Buzzer	322	
Xenon Strobe	-	367				
	Buzzer	323				
LED Multifunction	-	368				
	Buzzer	321				
 70x76x125	 70x76x125		Bulb Permanent	-	303	
				Buzzer	304	
			Bulb Blinking	-	371	
				Buzzer	376	
Xenon Strobe	-	372				
	Buzzer	377				
LED Multifunction	-	374				
	Buzzer	378				
 70x70x200	 70x70x281		Optional	100mm	10	
				200mm	20	
				300mm	30	
				400mm	40	
500mm	50					
800mm	80					
1000mm	100					

HOW TO ORDER

MS . .

[MODEL] [VOLTAGE]

- 1 - red
- 2 - green
- 3 - amber
- 4 - white
- 5 - blue

Voltage Chart

Bulb Permanent	Bulb Blinking	Xenon Strobe	LED Multifunction
12VDC	12VDC	24VAC/DC	12-24VAC/DC
24VDC	24VDC	220VAC	110-220VAC
110VAC	220VAC	110VAC	
220VAC			

- *LED Multifunction: 3 flash, blinking, steady
- *LED rotator is optional
- *Aluminum tube should be ordered separately

Signal Towers

Ø70mm 1 Tier Signal Towers

	With buzzer	Mounting	Series	Light	Buzzer	Model
 70x100x120	 70x100x203		8300	Bulb Permanent	-	8300
				Buzzer		433
				Bulb Blinking	-	83001
				Buzzer		410
				Xenon Strobe	-	83002
				Buzzer		409
				LED Multifunction	-	83003
				Buzzer		434
 70x70x207	 70x70x290		8400	Bulb Permanent	-	8400
				Buzzer		411
				Bulb Blinking	-	84002
				Buzzer		413
				Xenon Strobe	-	84003
				Buzzer		412
				LED Multifunction	-	84004
				Buzzer		437
 70x100x175	 70x100x260		8500	Bulb Permanent	-	8500
				Buzzer		414
				Bulb Blinking	-	85001
				Buzzer		415
				Xenon Strobe	-	85002
				Buzzer		416
				LED Multifunction	-	85003
				Buzzer		417
 70x76x134	 70x76x134		8600	Bulb Permanent	-	8600
				Buzzer		402
				Bulb Blinking	-	86001
				Buzzer		406
				Xenon Strobe	-	86002
				Buzzer		4810
				LED Multifunction	-	86004
				Buzzer		424
 70x70x207	 70x70x290		Optional		100mm	10
					200mm	20
					300mm	30
					400mm	40
					500mm	50
					800mm	80
					1000mm	100

HOW TO ORDER

MS . .
 [MODEL] [VOLTAGE]

- ① - red
- ② - green
- ③ - amber
- ④ - white
- ⑤ - blue

Voltage Chart			
Bulb Permanent	Bulb Blinking	Xenon Strobe	LED Multifunction
12VDC	12VDC	24VAC/DC	12-24VAC/DC
24VDC	24VDC	220VAC	110-220VAC
110VAC	220VAC	110VAC	
220VAC			

- *LED Multifunction: 3 flash, blinking, steady
- *Colored cap is optional
- *LED rotator is optional
- *Aluminum tube should be ordered separately
- *For Dome lens refer to page 4.

Signal Towers

Ø70mm 2 Tier Signal Towers

	With buzzer	Mounting	Series	Light	Buzzer	Model
 70x100x203	 70x100x286	Bracket Mounting 	8300	Bulb Permanent	-	83009
					Buzzer	492
		Bulb Blinking		-	83016	
				Buzzer	399	
Xenon Strobe	-	83012				
	Buzzer	398				
LED Multifunction	-	83010				
	Buzzer	465				
 70x70x290	 70x70x373	Tube Mounting 	8400	Bulb Permanent	-	84008
					Buzzer	499
		Bulb Blinking		-	84009	
				Buzzer	439	
Xenon Strobe	-	84010				
	Buzzer	498				
LED Multifunction	-	84011				
	Buzzer	454				
 70x100x258	 70x100x343	Tube/Wall Mounting 	8500	Bulb Permanent	-	85005
					Buzzer	85011
		Bulb Blinking		-	85006	
				Buzzer	85013	
Xenon Strobe	-	85032				
	Buzzer	85014				
LED Multifunction	-	85007				
	Buzzer	85015				
 70x76x217	 70x76x217	Wall Mounting 	8600	Bulb Permanent	-	86006
					Buzzer	495
		Bulb Blinking		-	86007	
				Buzzer	497	
Xenon Strobe	-	86005				
	Buzzer	86010				
LED Multifunction	-	86008				
	Buzzer	4035				
 70x70x290	 70x70x373	Ø30 Tube Aluminum 	Optional		100mm	10
					200mm	20
					300mm	30
					400mm	40
					500mm	50
					800mm	80
					1000mm	100

HOW TO ORDER

MS . .

[MODEL] [VOLTAGE]

- ① - red
- ② - green
- ③ - amber
- ④ - white
- ⑤ - blue

*For different color combinations please contact us.

Voltage Chart

Bulb Permanent	Bulb Blinking	Xenon Strobe	LED Multifunction
12VDC	12VDC	24VAC/DC	12-24VAC/DC
24VDC	24VDC	220VAC	110-220VAC
110VAC	220VAC	110VAC	
220VAC			

*LED Multifunction: 3 flash, blinking, steady

*Dome lens on top is optional

*Colored cap is optional

*LED rotator is optional

*Aluminum tube should be ordered separately

Signal Towers

Ø70mm 3 Tier Signal Towers

	With buzzer	Mounting	Series	Light	Buzzer	Model
 70x100x286	 70x100x371	Bracket Mounting 	8300	Bulb Permanent	-	83013
					Buzzer	436
		Bulb Blinking		-	83019	
				Buzzer	4020	
Xenon Strobe	-	83020				
	Buzzer	4026				
LED Multifunction	-	83017				
	Buzzer	310				
 70x70x373	 70x70x456	Tube Mounting 	8400	Bulb Permanent	-	84012
					Buzzer	443
		Bulb Blinking		-	84013	
				Buzzer	444	
Xenon Strobe	-	84019				
	Buzzer	401				
LED Multifunction	-	84022				
	Buzzer	4001				
 70x100x343	 70x100x426	Tube/Wall Mounting 	8500	Bulb Permanent	-	85008
					Buzzer	85016
		Bulb Blinking		-	85009	
				Buzzer	85017	
Xenon Strobe	-	85010				
	Buzzer	85018				
LED Multifunction	-	85034				
	Buzzer	467				
 70x76x290	 70x76x290	Wall Mounting 	8600	Bulb Permanent	-	86003
					Buzzer	484
		Bulb Blinking		-	86011	
				Buzzer	485	
Xenon Strobe	-	86012				
	Buzzer	423				
LED Multifunction	-	86015				
	Buzzer	86017				
 70x70x373	 70x70x456	Ø30 Tube Aluminum 	Optional		100mm	10
					200mm	20
				300mm	30	
				400mm	40	
		500mm	50			
		800mm	80			
		1000mm	100			

HOW TO ORDER

MS . .

[MODEL] [VOLTAGE]

- ① - red
- ② - green
- ③ - amber
- ④ - white
- ⑤ - blue

*For different color combinations please contact us.

Voltage Chart

Bulb Permanent	Bulb Blinking	Xenon Strobe	LED Multifunction
12VDC	12VDC	24VAC/DC	12-24VAC/DC
24VDC	24VDC	220VAC	110-220VAC
110VAC	220VAC	110VAC	
220VAC			

- *LED Multifunction: 3 flash, blinking, steady
- *Dome lens on top is optional
- *Colored cap is optional
- *LED rotator is optional
- *Aluminum tube should be ordered separately

Signal Towers

Ø70mm 4 Tier Signal Towers

		With buzzer	Mounting	Series	Light	Buzzer	Model
 70x100x371	 70x100x454	 Bracket Mounting	8300	Bulb Permanent	-	83014	
					Buzzer	83005	
				Bulb Blinking	-	83028	
					Buzzer	477	
Xenon Strobe	-	83031					
	Buzzer	452					
LED Multifunction	-	83018					
	Buzzer	83032					
 70x70x456	 70x70x540	 Tube Mounting	8400	Bulb Permanent	-	84020	
					Buzzer	422	
				Bulb Blinking	-	419	
					Buzzer	84016	
Xenon Strobe	-	84024					
	Buzzer	84025					
LED Multifunction	-	84014					
	Buzzer	468					
 70x100x426	 70x100x510	 Tube/Wall Mounting	8500	Bulb Permanent	-	85019	
					Buzzer	85020	
				Bulb Blinking	-	85033	
					Buzzer	85021	
Xenon Strobe	-	85022					
	Buzzer	85023					
LED Multifunction	-	85024					
	Buzzer	461					
 70x76x373	 70x76x373	 Wall Mounting	8600	Bulb Permanent	-	86018	
					Buzzer	86019	
				Bulb Blinking	-	86013	
					Buzzer	86020	
Xenon Strobe	-	86021					
	Buzzer	86022					
LED Multifunction	-	86023					
	Buzzer	464					
 70x70x456	 70x70x540	 Ø30 Tube Aluminum	Optional	100mm	10		
				200mm	20		
				300mm	30		
				400mm	40		
				500mm	50		
				800mm	80		
				1000mm	100		

HOW TO ORDER

MS . .

[MODEL] ① - red [VOLTAGE]

 ② - green

 ③ - amber

 ④ - white

 ⑤ - blue

Voltage Chart			
Bulb Permanent	Bulb Blinking	Xenon Strobe	LED Multifunction
12VDC	12VDC	24VAC/DC	12-24VAC/DC
24VDC	24VDC	220VAC	110-220VAC
110VAC	220VAC	110VAC	
220VAC			

*For different color combinations please contact us.

- *LED Multifunction: 3 flash, blinking, steady
- *Dome lens on top is optional
- *Colored cap is optional
- *LED rotator is optional
- *Aluminum tube should be ordered separately

Signal Towers

Ø70mm 5 Tier Signal Towers

	With buzzer	Mounting	Series	Light	Buzzer	Model
 70x100x454	 70x100x537	Bracket Mounting 	8300	Bulb Permanent	-	83015
					Buzzer	83033
				Bulb Blinking	-	83035
					Buzzer	4037
				Xenon Strobe	-	83026
					Buzzer	83034
LED Multifunction	-	83025				
	Buzzer	4036				
 70x70x540	 70x70x623	Tube Mounting 	8400	Bulb Permanent	-	84017
					Buzzer	400
				Bulb Blinking	-	84027
					Buzzer	408
				Xenon Strobe	-	84028
					Buzzer	84029
LED Multifunction	-	84030				
	Buzzer	393				
 70x100x510	 70x100x593	Tube/Wall Mounting 	8500	Bulb Permanent	-	85012
					Buzzer	85025
				Bulb Blinking	-	85026
					Buzzer	85027
				Xenon Strobe	-	85028
					Buzzer	85029
LED Multifunction	-	85030				
	Buzzer	85031				
 70x76x456	 70x76x456	Wall Mounting 	8600	Bulb Permanent	-	86024
					Buzzer	86025
				Bulb Blinking	-	86014
					Buzzer	86026
				Xenon Strobe	-	86027
					Buzzer	86028
LED Multifunction	-	86029				
	Buzzer	86030				
 70x70x540	 70x70x623	Ø30 Tube Aluminum 	Optional		100mm	10
					200mm	20
					300mm	30
					400mm	40
					500mm	50
					800mm	80
	1000mm	100				

HOW TO ORDER

MS . .

[MODEL] ① - red [VOLTAGE]

 ② - green

 ③ - amber

 ④ - white

 ⑤ - blue

Voltage Chart			
Bulb Permanent	Bulb Blinking	Xenon Strobe	LED Multifunction
12VDC	12VDC	24VAC/DC	12-24VAC/DC
24VDC	24VDC	220VAC	110-220VAC
110VAC	220VAC	110VAC	
220VAC			

- *LED Multifunction: 3 flash, blinking, steady
- *Dome lens on top is optional
- *Colored cap is optional
- *LED rotator is optional
- *Aluminum tube should be ordered separately

*For different color combinations please contact us.

190 Mini Motor Siren



Voltage	220V AC	110V AC	24V AC/DC	12V DC AC
Current	0.43A	0.9A	2.5A	6A
Power	40W			
Weight(kg)	0.55	0.4	0.4	0.4
Sound Pressure	115dB			
Material	Steel			
IP	44			
Dimensions	83x82x75mm			

192 Double Mini Motor Siren



Voltage	220VAC	24VDC
Current range	0.86A	5A
Power	80W	
Sound Pressure	120dB x 2	
Material	Steel	
IP	44	
Dimensions	83x200x82mm	

390 Motor Siren



Voltage	220V AC	110V AC	24V DC	24V AC
Current	1A	2A	6.8A	6.8A
Power	100W			
Weight(kg)	2.2	2.2	1.6	1.6
Sound Pressure	125dB			
Material	Steel			
IP	44			
Dimensions	215x132x145mm			

392 Double Motor Siren



Voltage	220VAC	24VDC
Current range	2A	13.6A
Power	200W	
Sound Pressure	125dB x 2	
Material	Steel	
IP	44	
Dimensions	132x440x160mm	

290 NO 1 Motor Siren



Voltage	220VAC
Current range	1.46A
Power range	150W
Sound Pressure	120dB
Material	Aluminum
IP	44
Weight(kg)	3.34kg
Dimensions	106x175x230mm with hood

490 Motor Siren



Voltage	220VAC	24VDC
Current range	1A	6.8A
Power range	100W	
Sound Pressure	125dB	
Material	Aluminum	
IP	44	
Dimensions	160x400x420mm with hood	

67302 NO 2 Motor Siren



Voltage	220VAC
Current range	2A
Power range	200W
Sound Pressure	135dB
Material	Aluminum
IP	44
Weight	4.5kg
Dimensions	106x175x230mm with hood

690 NO 4 Motor Siren



Voltage	220VAC
Current range	2A
Power range	400W
Sound Pressure	160dB
Material	Aluminum
IP	44
Dimensions	160x400x420mm with hood

HOW TO ORDER

MS .
[MODEL] [VOLTAGE]

* For motor sirens maximum load time is 2min



Buzzers

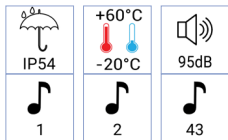

Model	1260	1258	1262	1264	1267
Mounting:	Wall mounting	Wall mounting	Wall/Tube mounting	Base mounting	Tube mounting
Tone:	1	43	1	1	1
Sound Output:	95dB	95dB	95dB	95dB	95dB
Current:	< 30 mA				
Dimensions(mm):	70x76x90	70x76x90	70x70x150	70x100x110	70x70x170
Voltages:	3-24VAC/DC 24VAC/DC 48VAC/DC 110VAC/DC 220VAC/DC	24VAC/DC 220VAC/DC	3-24VAC/DC 24VAC/DC 48VAC/DC 110VAC/DC 220VAC/DC	3-24VAC/DC 24VAC/DC 48VAC/DC 110VAC/DC 220VAC/DC	3-24VAC/DC 24VAC/DC 48VAC/DC 110VAC/DC 220VAC/DC

*3-24VAC/DC models have 2 tones.

HOW TO ORDER

MS **1260** . **3-24VAC/DC**
[MODEL] [VOLTAGE]

5802/5804 Electronic Siren with External Volume Control



- Alternating and pulsing tones or 43 tones
- Wall mounting 70x70x180mm
- 120 dB sound pressure external volume controller knob
- Clear and distinctive sound signals
- For industrial and general applications
- ABS
- IP54

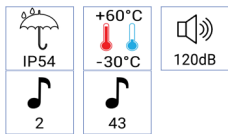

Model:	5802		5804	
Tone:	2 tones		43 tones	
Color:	Black	Red	Black	Red
Voltages:	12-24VAC/DC	85-260VAC	12-24VAC/DC	85-260VAC
Current:	12-30mA	9-4.5mA	12-30mA	9-4.5mA
Order no:	MS 5802.12-24VAC/DC	MS 5802.85-260VAC	MS 5804.12-24VAC/DC	MS 5804.85-260VAC

5852 Loud Electronic Siren

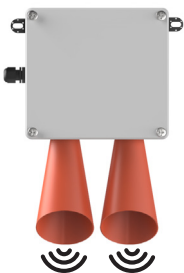

- For loud volume needs
- Wall mounting easy assembly
- 43 Tone electronic siren
- Low power consumption
- For industrial and general applications
- PC and ABS 85x113x203

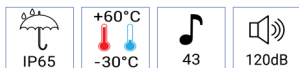

Model:	5852	
Tone:	43 tones	
Voltages:	12-24VAC/DC	85-260VAC
Current:	24-60mA	18-9mA
Order no:	MS 5852.12-24VAC/DC	MS 5852.85-260VAC

Ø28 (M28) Buzzer Screw / Spades Type



- Panel-mount buzzer
- Max. 95 dB sound pressure
- Sound pressure can be reduced by ~10 dB via turning window
- Panel size Ø 28 mm/M28
- Pulsing tone
- Connection via Spades 6.3 x 0.8 mm or screws
- For industrial and general applications
- Sealed electronics, low current consumption

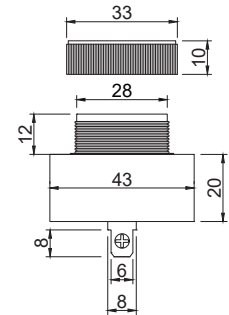

Connection:	1 tone				2 tones
	Spades/Screws	Spades/Screws	Spades	Spades	Spades/Screws
Current:	< 30 mA				
Voltages:	220VAC/DC	24VAC/DC	110VAC/DC	48VAC/DC	220VAC/DC
Order no:	MS 1210	MS 1202	MS 1204	MS 1208	MS 1216

Ø28 (M28) Buzzer Terminal Type



- Panel-mount buzzer
- Max. 95 dB sound pressure
- Sound pressure can be reduced by ~10 dB via turning window
- Panel size Ø 28 mm/M28
- Pulsing tone / Steady tone(1212)
- Connection via terminal
- For industrial and general applications
- Sealed electronics, low current consumption

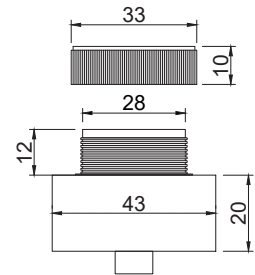

Current:	1 tone		2 tones
	< 30 mA		
Voltages:	220VAC/DC	24VAC/DC	3-24VAC/DC
Order no:	MS 1201	MS 1200	MS 1212

Ø28 (M28) Multi Tone Buzzer

new

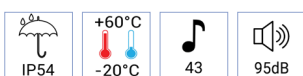
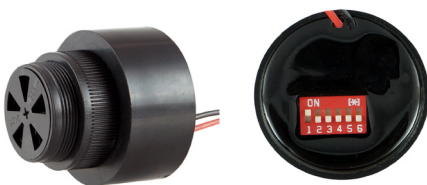

- Panel-mount buzzer
- Max. 95 dB sound pressure
- 43 tone selectable via dipswitch
- Sound pressure can be reduced by ~10 dB via turning window
- Panel size Ø 28 mm/M28
- Connection via cable
- For industrial and general applications
- Sealed electronics, low current consumption

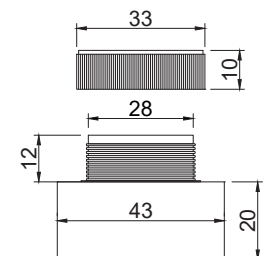

Current:	43 tones	
	< 30 mA	
Voltages:	220VAC/DC	12-24VAC/DC
Order no:	MS 1213	MS 1215

Ø28 (M28) LED Buzzer

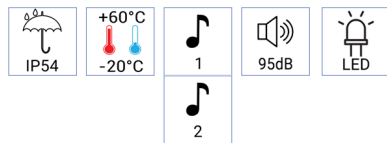

- Panel-mount LED buzzer
- LED flashing
- Max. 95 dB sound pressure
- Panel size Ø 28 mm/M28
- Pulsing tone / Steady tone (1207)
- Connection via terminal or spades(1217)
- For industrial and general applications
- Sealed electronics, low current consumption

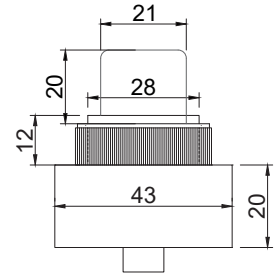

	1 tone		2 tone	
Connection:	Terminal	Terminal	Spades	Terminal
Current:	< 30 mA			
Voltages:	220VAC/DC	24VAC/DC	24VAC/DC	3-24VAC/DC
Order no:	MS 1211	MS 1205	MS 1217	MS 1207

691 Alarm Bell

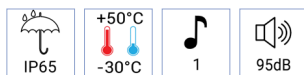

- Robust housing prevents damage when used in public area or in harsh industrial environments
- IP65 Weatherproof
- Wall Mounting
- Steel bell, epoxy powder coated
- Dimensions (Ø x Depth): 154 mm x 76 mm



Typical applications

- Signalling break-time or machine activation warnings.
- As a bell or alarm
- Goods receiving areas
- Entry/exit applications
- Counter service call point, etc.

Specs				
Current:	60mA	25mA	120mA	30mA
Voltages:	220VAC	24VDC	110VAC	48-110VDC
Order no:	MS 691.220VAC	MS 691.24VDC	MS 691.110VAC	MS 691.48-110VDC

695/696 Mini Alarm Sounder



- 120 dB sound pressure
- Alarm tone
- Connection via cable
- For industrial and general applications
- Mounting via screws
- Low current consumption
- 40x40x60mm

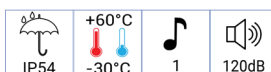

Specs		
Current:	200mA	300mA
Voltages:	220VAC/DC	12-24VAC/DC
Order no:	MS 695	MS 696

1259 Mini Buzzer



- 85 dB sound pressure
- Pulsing tone
- Connection via cable
- Mounting via screws or panel mount
- Low current consumption
- 35x30x25mm

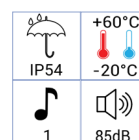

Specs	
Current:	<10 mA
Voltage:	24VDC
Order no:	MS 1259

5823/121 Electronic Siren



5823



121

- Alternating and pulsing tones
- Wall mounting
- 120 dB sound pressure
- Clear and distinctive sound signals
- For industrial and general applications
- ABS
- IP65

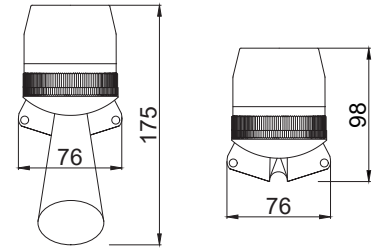

Model:	5823			
Color:	Black	Black	Black	Red
Voltage:	12-24V AC/DC	48-110 VDC	48-110 VAC	85-260 VAC

Model:	121			
Color:	Black	Black	Black	Red
Voltage:	12-24V AC/DC	48-110 VDC	48-110 VAC	85-260 VAC

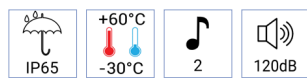

HOW TO ORDER

MS .
[MODEL] [VOLTAGE]

Model:	5822
Specs	Motion Detection Sensor
Voltages	220VAC
Order no:	MS 5822.220VAC

5824/122 Multi-Tone Electronic Siren



5824



122

- 43 Tone can be choosed via DIPSWITCH
- Internal potentiometer to adjust volume
- Wall mounting
- Max. 120 dB sound pressure
- Clear and distinctive sound signals
- For industrial and general applications
- ABS, ABS & PC(5824)
- IP65

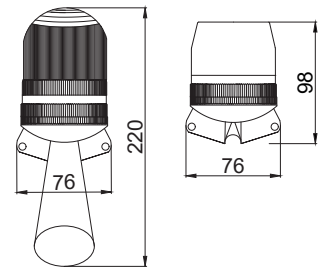

Model:	5824	
Color:	Black	Red
Voltages:	12-24VAC/DC	85-260VAC
Current:	9-4.5mA	13-30mA
Order no:	MS 5824.12-24VAC/DC	MS 5824.85-260VAC



Model:	122	
Color:	Black	Red
Voltages:	12-24VAC/DC	85-260VAC
Current:	9-4.5mA	13-30mA
Order no:	MS 122.12-24VAC/DC	MS 122.85-260VAC

5820/4820 Electromechanical Horn



5820



4820

- Horn sound
- Wall mounting
- 98dB sound pressure
- Clear and distinctive sound signals
- For industrial and general applications
- ABS
- IP65

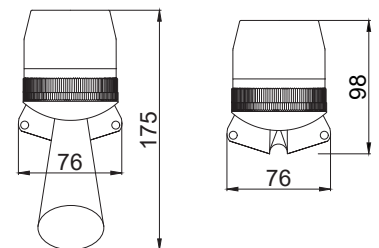

Model:	5820		4820	
Color:	Black	Red	Black	Red
Voltages:	24VDC	220VAC	24VDC	220VAC
Order no:	MS 5820.24VDC	MS 5820.220VAC	MS 4820.24VDC	MS 4820.220VAC

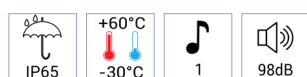

200 Series Electronic Multi-Tone Sounder



- Robust housing prevents damage when used in public are as or in harsh industrial environments
- Clear and distinctive sound signals
- For industrial and general applications
- Multi tone(43)
- Wall Mounting
- ABS

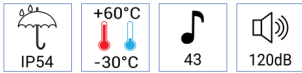
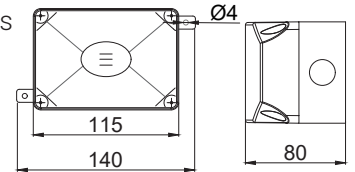

Model	200	214	212	216	204
Tone:	43	43	43	16	43
Specialty:	-	External Volume Control	Spark proof	-	5 external contacts
Sound Output:	70-120dB	0-120dB	70-120dB	70-100dB	70-120dB
Voltages:	12-24VAC/DC(13-30mA) 48-110VDC 85-260VAC (9-4.5mA)	12-24VAC/DC (13-30mA) 85-260VAC (9-4.5mA)	12-24VAC/DC (13-30mA) 85-260VAC (9-4.5mA)	12-24VDC	12-24VAC/DC (13-30mA) 85-260VAC (9-4.5mA)

HOW TO ORDER

MS .
[MODEL] [VOLTAGE]

281 Electronic Multi-Tone Sounder



- 43 Tone can be chosen via DIPSWITCH
- Robust housing prevents damage when used in public are as or in harsh industrial environments
- Clear and distinctive sound signals
- IP66 Weatherproof
- Wall Mounting
- ABS
- For industrial and general applications

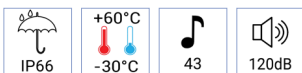
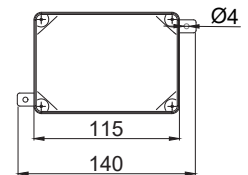

Model:	281	
Current:	9-4.5mA	13-30mA
Voltages:	85-260VAC	12-24VAC/DC
Order no:	MS 281.85-260VAC	MS 281.12-24VAC/DC

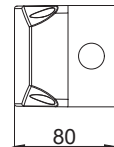

5821 Electromechanical Signal Horn



- Horn sound
- Robust housing prevents damage when used in public are as or in harsh industrial environments
- IP55
- 100dB
- Wall Mounting

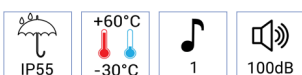

Model:	5821		
Dimensions:	133x128x292mm		
Voltages:	220VAC	220VDC	24VDC
Current:	170mA	170mA	1A
Order no:	MS 5821.220VAC	MS 5821.220VDC	MS 5821.24VDC

Ø70mm Multicolor Beacons

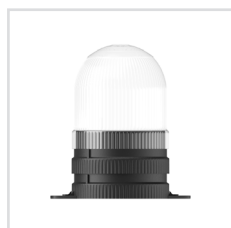

Bracket Mounting
299 - 294



Tube Mounting
298 - 293



Wall Mounting
292 - 297



Wall Mount
Cone shape
5850 - 5851



Bracket Mounting
IP54
482 - 483

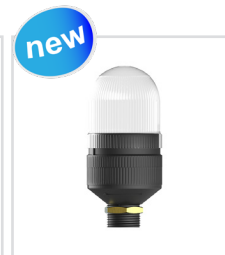

M30 Installation
335 - 336

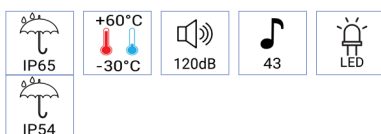

- 7 colors can be controlled via contact cables or button inside the lens
- 2 visual light effects (blinking or permanent light)
- 43 Tone Buzzer up to 120dB
- Buzzer on off and volume control feature via potentiometer
- PC and ABS



Model	Mounting	Light	Type	Buzzer	Dimensions
299	Bracket Mounting	Multicolor Permanent / Blinking	Manual	85db	70x100x115
294			Contact	85db	70x100x115
298	Tube Mounting	Multicolor Permanent / Blinking	Manual	85db	70x70x170
293			Contact	85db	70x70x170
292	Wall Mounting	Multicolor Permanent / Blinking	Manual	85db	70x70x90
297			Contact	85db	70x70x90
5850	Wall Mount Cone shape	Multicolor Permanent / Blinking	Manual	85db	70x70x220
5851			Contact	85db	70x70x220
482	Bracket Mounting IP54	Multicolor Permanent / Blinking	Manual	85db	95x95x110
483			Contact	85db	95x95x110
336	M30 Installation	Multicolor Permanent / Blinking	Contact	85db	70x70x125
335			Contact	-	70x70x125

Voltages Available: 110-220VAC and 12-24VAC/DC

HOW TO ORDER

MS .
[MODEL] [VOLTAGE]

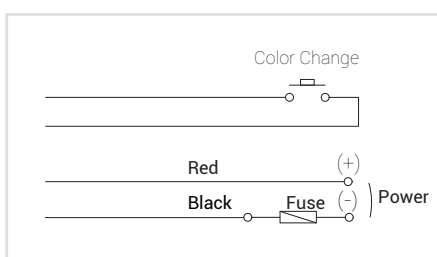

Manual Type

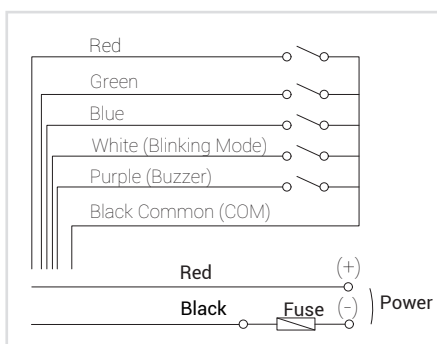

Contact Type

Light Colors for Contact Type				
RED CABLE	GREEN CABLE	BLUE CABLE	BLACK CABLE(COM)	Light Color
SC			SC	RED
	SC		SC	GREEN
		SC	SC	BLUE
SC	SC		SC	Amber
SC		SC	SC	PURPLE
	SC	SC	SC	CYAN
SC	SC	SC	SC	WHITE

SC: Short circuit with common black cable

*Standard lenses are clear, opaque lens is optional

Ø90 and Ø110 Multicolor Beacons



- 7 colors can be controlled via contact cables or button inside the lens
- 2 visual light effects (blinking or permanent light)
- 43 Tone Buzzer volume up to 120dB
- Buzzer on off feature via potentiometer
- PC and ABS, 599 is polyamid which is durable
- Dimensions: for 750 and 755 90x90x135mm for 599 170x170x300mm



HOW TO ORDER

MS .
 [MODEL] [VOLTAGE]

Model	Mounting	Material	Light	Type	Buzzer
750	Base	PC and ABS	RGB Light Permanent / Blinking	Manual	85db
755				Contact	85db
599	Base	PC and Polyamid		Manual	85db

Voltages Available: 110-220VAC and 12-24VAC/DC
 For wiring information please see previous page

Ø70mm Multicolor Signal Towers



- 7 colors can be controlled via button inside the lens
- 2 visual light effects (blinking or permanent light)
- Buzzer tone up to 95dB
- PC and ABS

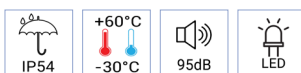
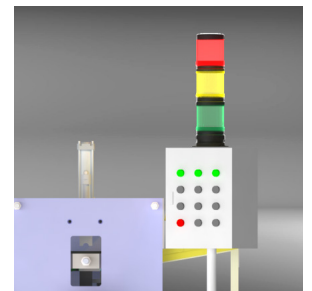

	Model	Color	Voltages
1 Tier	83041	7 COLORS	12-24VAC/DC 110-220VAC
2 Tier	83042		
3 Tier	83043		
4 Tier	83044		
5 Tier	83045		

Mounting	Part
Bracket Mounting	12
Tube Mounting	13
Tube/Wall Mounting	14
Wall Mounting	15

Buzzer	Part
Without Buzzer	0
With Buzzer	1

Aluminum Tube Mounting	Part
Optional	
100mm	10
200mm	20
300mm	30
400mm	40
500mm	50
800mm	80
1000mm	100

- *For different color combinations please contact us
- *Dome lens on top is optional
- *Standard lenses are clear, opaque lens is optional
- *When buzzer is ordered product height is increased by 100mm(except wall mounting)

HOW TO ORDER

MS . . .
 [MODEL] [BUZZER] [MOUNTING PART] [VOLTAGE]

229 LED Flashing Beacon with Multi Tone Sounder

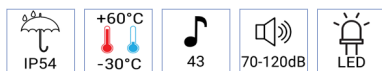

- LED multifunction 3 strobes, flashing, permanent modes
- Wall, Ceiling mounting easy assembly
- 43 Tone loud multi tone sounder
- Internal potentiometer to adjust sound level
- Low power consumption
- For industrial and general applications
- PC and ABS

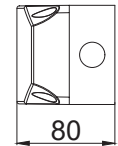
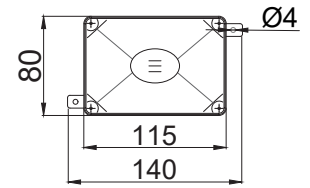

Color	110-220VAC	12-24VAC/DC
Red	MS 229.1.110-220VAC	MS 229.1.12-24VAC/DC
Green	MS 229.2.110-220VAC	MS 229.2.12-24VAC/DC
Amber	MS 229.3.110-220VAC	MS 229.3.12-24VAC/DC
White	MS 229.4.110-220VAC	MS 229.4.12-24VAC/DC
Blue	MS 229.5.110-220VAC	MS 229.5.12-24VAC/DC

251 LED Flashing Beacon with Multi Tone Sounder



- LED multifunction 3 strobes, flashing, permanent modes
- Wall, Ceiling mounting easy assembly
- 43 Tone loud multi tone sounder
- Internal potentiometer to adjust sound level
- Low power consumption
- For industrial and general applications
- PC and ABS

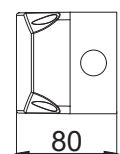
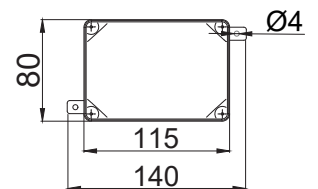

Color	110-220VAC	12-24VAC/DC
Red	MS 251.1.110-220VAC	MS 251.1.12-24VAC/DC
Green	MS 251.2.110-220VAC	MS 251.2.12-24VAC/DC
Amber	MS 251.3.110-220VAC	MS 251.3.12-24VAC/DC
White	MS 251.4.110-220VAC	MS 251.4.12-24VAC/DC
Blue	MS 251.5.110-220VAC	MS 251.5.12-24VAC/DC

222-226 LED Flashing Beacon Combination with Multi Tone Sounder



- LED multifunction 3 strobes, flashing, permanent modes
- Wall, Ceiling mounting easy assembly
- 43 Tone loud multi tone sounder
- Internal potentiometer to adjust sound level
- Innovative connector to create light combinations
- Low power consumption
- For industrial and general applications
- PC and ABS

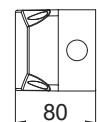
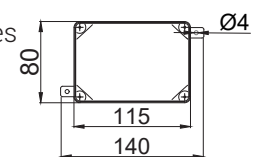

	Color	110-220VAC	12-24VAC/DC
1 Tier	Red	MS 222.1.110-220VAC	MS 222.1.12-24VAC/DC
	Green	MS 222.2.110-220VAC	MS 222.2.12-24VAC/DC
	Amber	MS 222.3.110-220VAC	MS 222.3.12-24VAC/DC
	Blue	MS 222.4.110-220VAC	MS 222.4.12-24VAC/DC
	White	MS 222.5.110-220VAC	MS 222.5.12-24VAC/DC
2 Tier	Red-Green	MS 223.1.2.110-220VAC	MS 223.1.2.12-24VAC/DC
3 Tier	Red-Amber-Green	MS 224.1.3.2.110-220VAC	MS 224.1.3.2.12-24VAC/DC
4 Tier	Red-Amber-Green-Blue	MS 225.1.3.2.5.110-220VAC	MS 225.1.3.2.5.12-24VAC/DC
5 Tier	Red-Amber-Green-Blue-White	MS 226.1.3.2.5.4.110-220VAC	MS 226.1.3.2.5.4.12-24VAC/DC

For different color combinations please contact us

201 / 232 Xenon or LED Combination with Multi Tone Sounder



- Xenon Strobe or LED multifunction 6 strobes, blinking, permanent, rotator modes
- Wall, Ceiling mounting easy assembly
- 43 Tone loud multi tone sounder
- Low power consumption
- For industrial and general applications
- PC and ABS

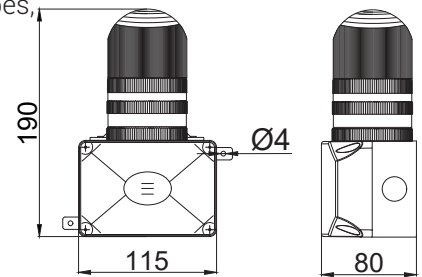

Model:	201		232	
Light:	Xenon strobe (double flash)		LED	
Voltages:	110-220VAC	12-24VAC/DC	110-220VAC	12-60VDC/AC
Red	MS 201.1.110-220VAC	MS 201.1.12-24VAC/DC	MS 232.1.110-220VAC	MS 232.1.12-60VDC/AC
Green	MS 201.2.110-220VAC	MS 201.2.12-24VAC/DC	MS 232.2.110-220VAC	MS 232.2.12-60VDC/AC
Amber	MS 201.3.110-220VAC	MS 201.3.12-24VAC/DC	MS 232.3.110-220VAC	MS 232.3.12-60VDC/AC
White	MS 201.4.110-220VAC	MS 201.4.12-24VAC/DC	MS 232.4.110-220VAC	MS 232.4.12-60VDC/AC
Blue	MS 201.5.110-220VAC	MS 201.5.12-24VAC/DC	MS 232.5.110-220VAC	MS 232.5.12-60VDC/AC

HOW TO ORDER

MS . .

[MODEL] [COLOR] [VOLTAGE]

① - red ② - green ③ - amber
 ④ - white ⑤ - blue

Additional Models		
Model	Light	Specs
207	Xenon	Volume adjustment
211	Xenon	5 tone contacts
233	LED Multifunction	Volume adjustment

Voltages Available: 110-220VAC and 12-24VAC/DC

Multi Tiers Combination with Multi Tone Sounder



- Xenon Strobe or LED multifunction 6 strobes, blinking, permanent, rotator modes
- Wall, Ceiling mounting easy assembly
- 43 Tone loud multi tone sounder
- Low power consumption
- For industrial and general applications
- PC and ABS

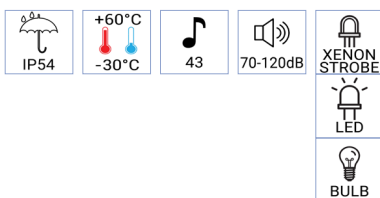
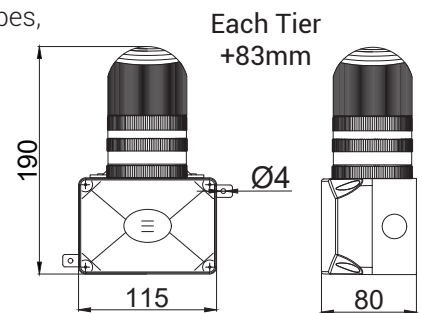

HOW TO ORDER

MS .

[MODEL] [VOLTAGE]

	Colors	Light	Specs	Model
2 Tier	Red-Green	Xenon	Double flash	213
		LED Multifunction	-	202
		LED Multifunction	Volume adjustment	215
3 Tier	Red-Amber-Green	LED Multifunction	-	208
		LED Multifunction	5 tone contacts	231
4 Tier	Red-Amber-Green-Blue	LED Multifunction	-	234
		LED Multifunction	5 tone contacts	235
		LED Multifunction	-	209
5 Tier	Red-Amber-Green-Blue-White	Bulb	Permanent	210

Voltages Available for LED and XENON: 110-220VAC and 12-24VAC/DC
 Bulb: 12VDC / 24VDC / 220VAC

For different color combinations please contact us

5811 Xenon Combination with 2 Tone Electronic Siren

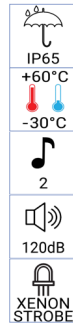

- Xenon Strobe Technology
- High visibility
- Wall mounting easy assembly
- 2 Tone loud Electronic Siren
- For industrial and general applications
- PC and ABS
- Short circuit thin cables in order to change tone

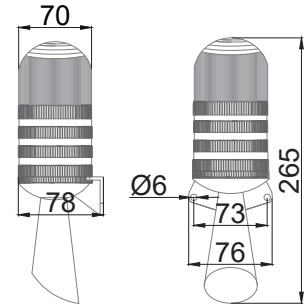

Model:	5811			
Voltages:	24VAC/DC	48-110VDC	48-110VAC	220VAC
Red	MS 5811.1.24VAC/DC	MS 5811.1.48-110VAC	MS 5811.1.48-110VAC	MS 5811.1.220VAC
Green	MS 5811.2.24VAC/DC	MS 5811.2.48-110VAC	MS 5811.2.48-110VAC	MS 5811.2.220VAC
Amber	MS 5811.3.24VAC/DC	MS 5811.3.48-110VAC	MS 5811.3.48-110VAC	MS 5811.3.220VAC
White	MS 5811.4.24VAC/DC	MS 5811.4.48-110VAC	MS 5811.4.48-110VAC	MS 5811.4.220VAC
Blue	MS 5811.5.24VAC/DC	MS 5811.5.48-110VAC	MS 5811.5.48-110VAC	MS 5811.5.220VAC

5826 LED Flashing Beacon with 2 Tone Electronic Siren

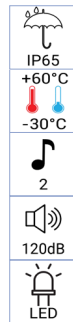

- LED Flashing
- Wall mounting easy assembly
- 2 Tone loud Electronic Siren
- Low power consumption
- For industrial and general applications
- PC and ABS
- Short circuit thin cables in order to change tone



Model:	5826			
Voltages:	12-24VAC/DC	48-110VDC	48-110VAC	110-220VAC
Red	MS 5826.1.12-24VAC/DC	MS 5826.1.48-110VAC	MS 5826.1.48-110VAC	MS 5826.1.110-220VAC
Green	MS 5826.2.12-24VAC/DC	MS 5826.2.48-110VAC	MS 5826.2.48-110VAC	MS 5826.2.110-220VAC
Amber	MS 5826.3.12-24VAC/DC	MS 5826.3.48-110VAC	MS 5826.3.48-110VAC	MS 5826.3.110-220VAC
White	MS 5826.4.12-24VAC/DC	MS 5826.4.48-110VAC	MS 5826.4.48-110VAC	MS 5826.4.110-220VAC
Blue	MS 5826.5.12-24VAC/DC	MS 5826.5.48-110VAC	MS 5826.5.48-110VAC	MS 5826.5.110-220VAC

5810 Xenon Beacon with Horn

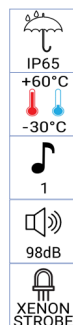

- Xenon Strobe
- Wall mounting easy assembly
- Horn sound
- For industrial and general applications
- PC and ABS

Model:	5810	
Voltages:	220VAC	24VDC
Red	MS 5810.1.220VAC	MS 5810.1.24VDC
Green	MS 5810.2.220VAC	MS 5810.2.24VDC
Amber	MS 5810.3.220VAC	MS 5810.3.24VDC
White	MS 5810.4.220VAC	MS 5810.4.24VDC
Blue	MS 5810.5.220VAC	MS 5810.5.24VDC

5830 LED blinking with Horn

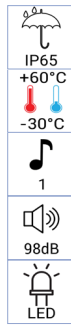

- LED blinking
- Wall mounting easy assembly
- Horn sound
- For industrial and general applications
- PC and ABS

Model:	5830	
Voltages:	220VAC	24VDC
Red	MS 5830.1.220VAC	MS 5830.1.24VDC
Green	MS 5830.2.220VAC	MS 5830.2.24VDC
Amber	MS 5830.3.220VAC	MS 5830.3.24VDC
Blue	MS 5830.4.220VAC	MS 5830.4.24VDC
White	MS 5830.5.220VAC	MS 5830.5.24VDC

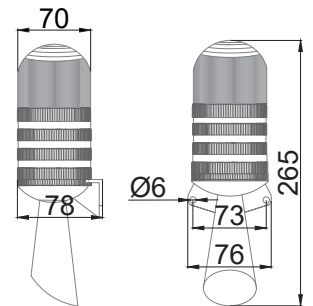

5825/5828 Bulb with 2 Tone Electronic Siren

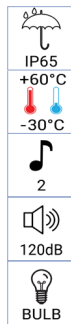

- Bulb blinking/permanent
- Wall mounting easy assembly
- 2 Tone Electronic Siren
- Low power consumption
- For industrial and general applications
- PC and ABS
- Short circuit thin cables in order to change tone

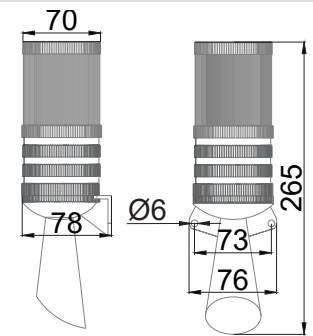

Model:	5825			5828		
Signal Effect:	Permanent			Blinking		
Color	12VDC	24VDC	220VAC	12VDC	24VDC	220VAC
Red	MS 5825.1.12VDC	MS 5825.1.24VDC	MS 5825.1.220VAC	MS 5828.1.12VDC	MS 5828.1.24VDC	MS 5828.1.220VAC
Green	MS 5825.2.12VDC	MS 5825.2.24VDC	MS 5825.2.220VAC	MS 5828.2.12VDC	MS 5828.2.24VDC	MS 5828.2.220VAC
Amber	MS 5825.3.12VDC	MS 5825.3.24VDC	MS 5825.3.220VAC	MS 5828.3.12VDC	MS 5828.3.24VDC	MS 5828.3.220VAC
White	MS 5825.4.12VDC	MS 5825.4.24VDC	MS 5825.4.220VAC	MS 5828.4.12VDC	MS 5828.4.24VDC	MS 5828.4.220VAC
Blue	MS 5825.5.12VDC	MS 5825.5.24VDC	MS 5825.5.220VAC	MS 5828.5.12VDC	MS 5828.5.24VDC	MS 5828.5.220VAC

5829 Bulb with Horn

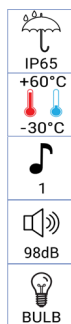

- Bulb permanent
- Wall mounting easy assembly
- Horn sound
- For industrial and general applications
- PC and ABS

Model:	5829	
Voltages:	24VDC	220VAC
Red	MS 5829.1.24VDC	MS 5829.1.220VAC
Green	MS 5829.2.24VDC	MS 5829.2.220VAC
Amber	MS 5829.3.24VDC	MS 5829.3.220VAC
White	MS 5829.4.24VDC	MS 5829.4.220VAC
Blue	MS 5829.5.24VDC	MS 5829.5.220VAC

5834/5815 LED Multifunction Buzzer Combination

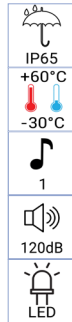

- LED multifunction 5 strobes, blinking, permanent, rotator modes
- Wall mounting easy assembly
- **Loud pulsed tone buzzer**
- Low power consumption
- For industrial and general applications
- PC and ABS

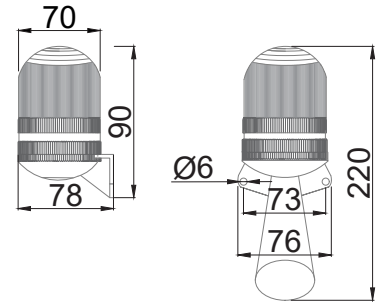

Model:	5834		5815	
Tone:	1 tone		1 tone	
Voltages:	12-60VAC/DC	85-260VAC	12-60VAC/DC	85-260VAC
Current	375-187mA	40-20mA	375-187mA	40-20mA
Red	MS 5834.1.12-60VAC/DC	MS 5834.1.85-260VAC	MS 5815.1.12-60VAC/DC	MS 5815.1.85-260VAC
Green	MS 5834.2.12-60VAC/DC	MS 5834.2.85-260VAC	MS 5815.2.12-60VAC/DC	MS 5815.2.85-260VAC
Amber	MS 5834.3.12-60VAC/DC	MS 5834.3.85-260VAC	MS 5815.3.12-60VAC/DC	MS 5815.3.85-260VAC
White	MS 5834.4.12-60VAC/DC	MS 5834.4.85-260VAC	MS 5815.4.12-60VAC/DC	MS 5815.4.85-260VAC
Blue	MS 5834.5.12-60VAC/DC	MS 5834.5.85-260VAC	MS 5815.5.12-60VAC/DC	MS 5815.5.85-260VAC

HOW TO ORDER

MS . .
 [MODEL] [Color] [VOLTAGE]
 ① - red ② - green ③ - amber
 ④ - white ⑤ - blue

Model:	5843	
Spec	External volume control	
Voltages	12-60VAC/DC	110-220VAC
Order no:	MS 5843.①.12-60VAC/DC	MS 5843.①.110-220VAC

5847/440 LED Multifunction Multi-Tone Combination



- LED multifunction 5 strobes, blinking, permanent, rotator modes
- Wall mounting easy assembly
- **Loud 43 Tone siren**
- Low power consumption
- For industrial and general applications
- PC and ABS



Model:	5847		440	
Tone:	43 tones		43 tones	
Voltages:	12-60VAC/DC	110-220VAC	12-60VAC/DC	110-220VAC
Current	375-187mA	40-20mA	375-187mA	40-20mA
Red	MS 5847.1.12-60VAC/DC	MS 5847.2.110-220VAC	MS 440.1.12-60VAC/DC	MS 440.1.110-220VAC
Green	MS 5847.2.12-60VAC/DC	MS 5847.3.110-220VAC	MS 440.2.12-60VAC/DC	MS 440.2.110-220VAC
Amber	MS 5847.3.12-60VAC/DC	MS 5847.4.110-220VAC	MS 440.3.12-60VAC/DC	MS 440.3.110-220VAC
White	MS 5847.4.12-60VAC/DC	MS 5847.5.110-220VAC	MS 440.4.12-60VAC/DC	MS 440.4.110-220VAC
Blue	MS 5847.5.12-60VAC/DC	MS 5847.5.110-220VAC	MS 440.5.12-60VAC/DC	MS 440.5.110-220VAC



5836/5819/5833 2 Tiers Light with Electronic Siren



5836

5819

5833

- Bulb permanent or Xenon Strobe or LED
- Wall mounting easy assembly
- 2 Tone Electronic Siren
- Low power consumption
- For industrial and general applications
- PC and ABS
- Short circuit thin cables in order to change tone

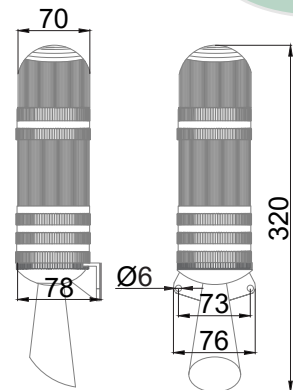

Model:	5836		5819	
Signal Effect	LED Flashing		Xenon	
Voltages:	24VAC/DC	110-220VAC	24VAC/DC	220VAC
Red-Green	MS 5836.1.2.24VAC/DC	MS 5836.1.2.110-220VAC	MS 5819.1.2.24VAC/DC	MS 5819.1.2.220VAC

Model:	5833	
Signal Effect	Bulb Permanent	
Voltages:	24VDC	220VAC
Red-Green	MS 5833.1.2.24VDC	MS 5833.1.2.220VAC

5844/5816/5817 3 Tiers Light with Electronic Siren



5844

5816

5817

- Bulb blinking or Xenon Strobe or LED
- Wall mounting easy assembly
- 2 Tone Electronic Siren
- Low power consumption
- For industrial and general applications
- PC and ABS
- Short circuit thin cables in order to change tone

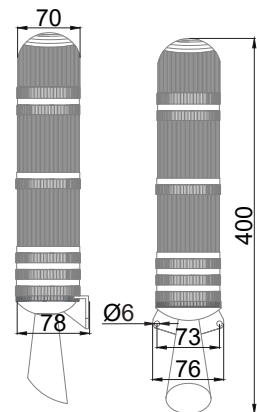

Model:	5844		5816	
Signal Effect:	LED Flashing		Xenon	
Color:	Red-Amber-Green			
Voltages:	24VAC/DC	220VAC	24VAC/DC	220VAC
Order no:	MS 5844.1.3.2.24VAC/DC	MS 5844.1.3.2.220VAC	MS 5816.1.3.2.24VAC/DC	MS 5816.1.3.2.220VAC

Model:	5817	
Signal Effect:	Bulb Blinking	
Color:	Red-Amber-Green	
Voltages:	24VDC	220VAC
Order no:	MS 5817.1.3.2.24VDC	MS 5817.1.3.2.220VAC

5805/5806/5807 High Volume Electronic Siren and LED combinations



5807

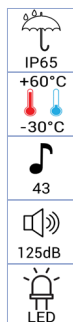

- For loud volume needs
- LED multifunction 3 strobes, flashing, permanent modes
- Wall mounting easy assembly
- Loud 43 Tone siren
- 2-3 independant tones could be choosed (2 tone for 5805, 3 for 5807-5806)
- Low power consumption
- For industrial and general applications
- PC and ABS

Model	Light	Tone	Electronic siren(qty)	Dimensions (mm)
5805	LED Multifunction	43 Tone	2 123dB	113x183x210
5806	LED Multifunction	43 Tone	3 125dB	113x183x210
5807	LED Multifunction	43 Tone	3 125dB	293x183x190

Voltages Available: 110-220VAC and 12-24VAC/DC

HOW TO ORDER

MS . .

[MODEL] [COLOR] [VOLTAGE]

- ① - red ② - green ③ - amber
- ④ - white ⑤ - blue



5805



5806

5812/5813/5814 Light and Electronic Siren Combinations

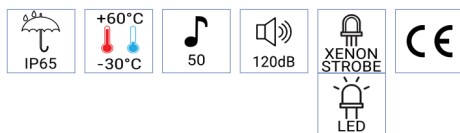

- Xenon strobe double flash or multifunction LED
- Wall mounting easy assembly
- Loud 50 tone can be choosed via dipswitch inside
- Sound pressure up to 120dB
- Low power consumption
- For industrial and general applications
- PC and ABS

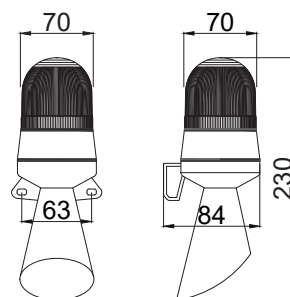

Model	Light	Tone
5812	Xenon strobe 2 flash	50 Tone
5813	LED Multifunction	50 Tone
5814	LED Blinking	50 Tone

Voltages Available: 110-220VAC and 12-24VDC

HOW TO ORDER

MS . .

[MODEL] [COLOR] [VOLTAGE]

- ① - red ② - green ③ - amber
- ④ - white ⑤ - blue





472/473/478 LED Buzzer Combinations for Machines



- LED multifunction 5 strobes, blinking, permanent, rotator modes
- Base and wall mounting easy assembly
- Loud pulsed tone buzzer
- Low power consumption
- For industrial and general applications
- PC and ABS compact design

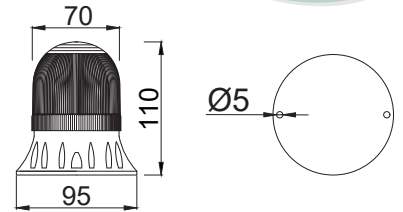

HOW TO ORDER

MS . .

[MODEL] [COLOR] [VOLTAGE]

① - red ② - green ③ - amber
④ - white ⑤ - blue

Model	Light	Tone	Specs
472	LED Multifunction	1 Tone	-
473	LED Multifunction	43 Tone	-
478	LED Multifunction	43 Tone	External Potentiometer

Voltages Available: 85-260VAC and 12-60VAC/DC

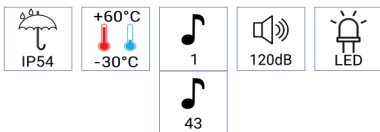

357 LED Buzzer Combinations



- LED multifunction 6 strobes, blinking, permanent, rotator modes
- Base and wall mounting easy assembly
- Loud pulsed tone buzzer
- Low power consumption
- For industrial and general applications
- PC and ABS

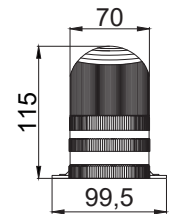

Voltages Available: 85-260VAC and 12-60VAC/DC

HOW TO ORDER

MS . .

[MODEL] [COLOR] [VOLTAGE]

① - red ② - green ③ - amber ④ - white ⑤ - blue

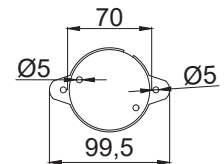

2 Sided Warning lights



2 Sided Dome

Dome

Cylindrical

Model	Type	Light	Buzzer
327	2 Sided Dome	Bulb permanent	-
328	2 Sided Dome	Bulb Blinking	-
329	2 Sided Dome	Xenon Strobe 2 flash	-
330	2 Sided Dome	Xenon + Bulb Blinking	-
331	2 Sided Dome	LED Multifunction	-
324	Dome	Xenon Strobe 2 flash	buzzer
325	Dome	Bulb permanent	buzzer
394	Dome	LED Multifunction	buzzer
446	Cylindrical	LED Multifunction	buzzer

Dimensions: 70x120x200mm

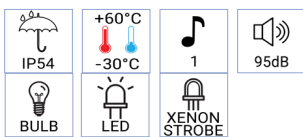

HOW TO ORDER

MS . . .

[MODEL] [Color1] [Color2] [VOLTAGE]

① - red ② - green ③ - amber
④ - white ⑤ - blue

Voltage Chart				
Light:	Bulb Permanent	Bulb Blinking	LED Multifunction	Xenon Strobe
Voltages:	12VDC 24VDC 110VAC 220VAC	24VDC 220VAC	12-24VAC/DC 110-220VAC	24VAC/DC 220VAC

Light with 2 Tone Electronic Siren

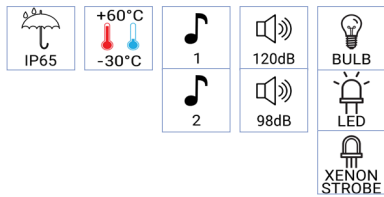

HOW TO ORDER

MS . .
 [MODEL] [VOLTAGE]

- 1 - red 2 - green 3 - amber
- 4 - white 5 - blue



- Light options
- Wall mounting easy assembly
- 2 Tone loud Electronic Siren or horn
- For industrial and general applications
- PC and ABS
- Short circuit thin cables in order to change tone

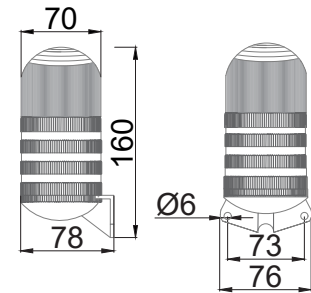

Model	Lens	Light	Tone	Sound Pressure
307	Dome	Bulb permanent	Electronic Siren 2 tone	120dB
308	Dome	Bulb Blinking	Horn	98dB
381	Dome	LED Multifunction	Electronic Siren 2 tone	120dB
306	Dome	Xenon Strobe 2 flash	Electronic Siren 2 tone	120dB
404	Cylindrical	Bulb permanent	Electronic Siren 2 tone	120dB
405	Cylindrical	Bulb Blinking	Horn	98dB
407	Cylindrical	Bulb Blinking	Electronic Siren 2 tone	120dB
430	Cylindrical	LED Multifunction	Horn	120dB
445	Cylindrical	LED blinking	Electronic Siren 2 tone	120dB
403	Cylindrical	Xenon Strobe 2 flash	Electronic Siren 2 tone	120dB

Voltage Chart

Light:	Bulb Permanent	Bulb Blinking	LED Multifunction	Xenon Strobe
Voltages:	12VDC 24VDC 110VAC 220VAC	24VDC 220VAC	12-24VAC/DC 110-220VAC	24VAC/DC 220VAC

LED Buzzer Combinations

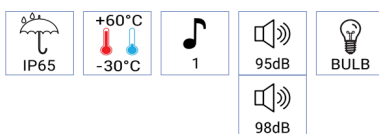

- Bulb permanent or bulb blinking
- Wall mounting easy assembly
- Loud pulsed tone buzzer or horn
- For industrial and general applications
- PC and ABS



Model	Light	Specs	Sound Pressure	Mounting	Dimensions (mm)
4800	Bulb Permanent E14	buzzer	95dB	Wall bracket	76x76x100
4801	Bulb Permanent E14	horn	98dB	Wall bracket	76x76x100
4805	Bulb Blinking	buzzer	95dB	Wall bracket	76x76x100
4807	Bulb Blinking	-	-	Wall bracket	76x76x100
5800	Bulb Permanent E14	horn	98dB	Wall bracket	76x76x220

Voltages available: 24VDC or 220VAC

HOW TO ORDER

MS . .
 [MODEL] [COLOR] [VOLTAGE]

- 1 - red 2 - green 3 - amber
- 4 - white 5 - blue

LED Buzzer and Xenon Buzzer Combinations



1266



1261
1265

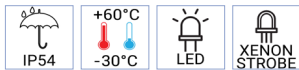

- Light options
- Wall mounting easy assembly
- For industrial and general applications
- ABS
- Buzzer sound 95dB

Specs			
Model	1266	1261	1265
Mounting:	Wall mounting	Wall mounting	Wall mounting
Tone:	1	1	1
Sound Output:	95dB	95dB	95dB
Light:	LED	Bulb	Xenon strobe 2 flash
Dimensions(mm):	76x76x110	76x78x90	76x78x90
Voltages:	3-24VAC/DC 24VAC/DC 220VAC/DC	24VDC 220VAC	24VAC/DC 220VAC

*3-24VAC/DC models have 2 tones.

HOW TO ORDER

MS .
 [MODEL] [VOLTAGE]

Warning Beacons

300 Series



356
351



355
332



373
3730



358

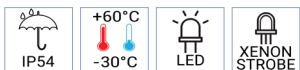

- Light options
- Base or Wall mounting easy assembly
- For industrial and general applications
- PC and ABS
- Optional photosensor for light to turn on automatically at dusk

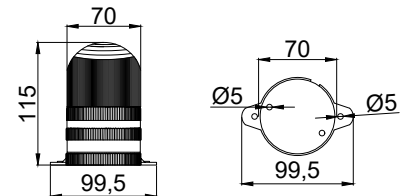

Model	Light	Specs	Mounting	Dimensions(mm)
356	LED Tower multifunction		Base mount	70x100x115
351	LED multifunction w/out Reflector suitable for wall mounting		Base mount	70x100x115
355	LED multifunction with Reflector	Photosensor	Base mount	70x100x115
332	Xenon strobe 2 flash	Photosensor	Base mount	70x100x115
373	LED multifunction		E27 plug	70x70x120
3730	Xenon strobe 2 flash		E27 plug	70x70x120
358	Xenon strobe 2 flash	-	Magnetic mount with cigarette plug	70x100x120

Voltage Chart

Light:	LED Multifunction	Xenon Strobe
Voltages:	12-24VAC/DC 110-220VAC	24VAC/DC 220VAC

MS . .
 [MODEL] [COLOR] [VOLTAGE]

- ① - red ② - green ③ - amber
 ④ - white ⑤ - blue

Warning Beacons

Ø50mm Compact Beacons

Compact Beacons



8520/8521
8524/8522



8523
8556



8540
8541



8527
8542



8550/8543



8544/8552



8553

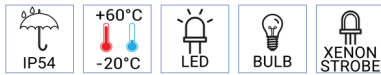

HOW TO ORDER

MS **8520** . **1** . **12VDC**

[MODEL] **1** - red [VOLTAGE]

- 2** - green
- 3** - amber
- 4** - white
- 5** - blue

Model	Light	Mounting	Dimensions (mm)
8520	Bulb permanent	PG13 Cable Gland	50x50x60
8521	Bulb Blinking	PG13 Cable Gland	50x50x60
8524	LED Multifunction	PG13 Cable Gland	50x50x60
8522	Xenon Strobe 2 flash	PG13 Cable Gland	50x50x60
8523	Bulb permanent	Wall bracket	50x53x60
8556	LED Multifunction	Wall bracket	50x53x60
8540	Bulb permanent	E27 Socket	50x50x64
8541	LED Multifunction	E27 Socket	50x50x64
8527	Bulb permanent	Short tube	45x70x90
8542	LED Multifunction	Short tube	45x70x90
8550	Bulb permanent	Tube	45x70x190
8543	LED Multifunction	Tube	45x70x190
8544	LED Multifunction	Tube model 2	45x70x190
8552	Bulb permanent	Tube model 2	45x70x190
8553	Bulb permanent 2 sided	Wall tube	70x100x350

Light:	Bulb Permanent	Bulb Blinking	LED Multifunction	Xenon Strobe
Voltages:	12VDC 24VDC 110VAC 220VAC	12VDC 24VDC 220VAC	12-24VAC/DC 110-220VAC	24VAC/DC 220VAC

Ø70 Mini Warning Beacons

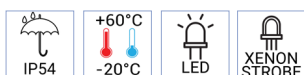

HOW TO ORDER

MS **83006** . **1** . **24VAC/DC**

[MODEL] **1** - red [VOLTAGE]

- 2** - green
- 3** - amber
- 4** - white
- 5** - blue

- Compact can easily fit anywhere
- Base or Wall mounting
- Clear visual signals
- For industrial and general applications
- ABS
- IP54

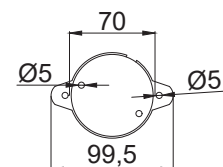
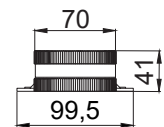

Model	Light	Voltage	Mounting	Dimensions(mm)
83006	Xenon Strobe	24VAC/DC 220VAC	Base mount	100x70x40
83030	LED	12-24VAC/DC 110-220VAC	Base mount	100x70x40

250 LED Flashing Beacon

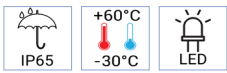

Traffic light combination

Combination with multi tone sounder

- LED multifunction 3 strobes, flashing, permanent modes
- Wall, Ceiling mounting easy assembly
- Innovative connector to create light combinations
- Low power consumption
- For industrial and general applications
- PC and ABS

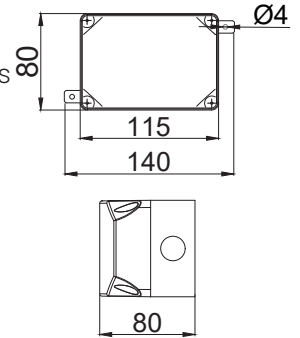

	Color	110-220VAC	12-24VAC/DC
1 Tier	Red	MS 250.1.110-220VAC	MS 250.1.12-24VAC/DC
	Green	MS 250.2.110-220VAC	MS 250.2.12-24VAC/DC
	Amber	MS 250.3.110-220VAC	MS 250.3.12-24VAC/DC
	White	MS 250.4.110-220VAC	MS 250.4.12-24VAC/DC
	Blue	MS 250.5.110-220VAC	MS 250.5.12-24VAC/DC
2 Tier	Red-Green	MS 218.1.2.110-220VAC	MS 218.1.2.12-24VAC/DC
3 Tier	Red-Amber-Green	MS 219.1.3.2.110-220VAC	MS 219.1.3.2.12-24VAC/DC
4 Tier	Red-Amber-Green-Blue	MS 220.1.3.2.5.110-220VAC	MS 220.1.3.2.5.12-24VAC/DC
5 Tier	Red-Amber-Green-Blue-White	MS 221.1.3.2.5.4.110-220VAC	MS 221.1.3.2.5.4.12-24VAC/DC

For different color combinations please contact us

309/383 M30 Installation Mount Beacons

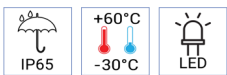

- LED multifunction 6 strobes, blinking, permanent, rotator modes
- M30 Installation buzzer
- Brass hex nut
- 50.000hour LED life time
- Low power consumption
- For industrial and general applications
- PC and ABS

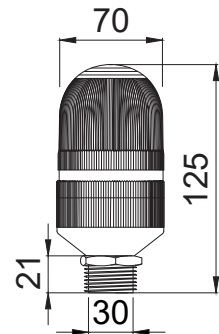

Buzzer	Color	110-220VAC	12-24VAC/DC
-	Red	MS 309.1.110-220VAC	MS 309.1.12-24VAC/DC
	Green	MS 309.2.110-220VAC	MS 309.2.12-24VAC/DC
	Amber	MS 309.3.110-220VAC	MS 309.3.12-24VAC/DC
	White	MS 309.4.110-220VAC	MS 309.4.12-24VAC/DC
	Blue	MS 309.5.110-220VAC	MS 309.5.12-24VAC/DC
85dB	Red	MS 383.1.110-220VAC	MS 383.1.12-24VAC/DC
	Green	MS 383.2.110-220VAC	MS 383.2.12-24VAC/DC
	Amber	MS 383.3.110-220VAC	MS 383.3.12-24VAC/DC
	White	MS 383.4.110-220VAC	MS 383.4.12-24VAC/DC
	Blue	MS 383.5.110-220VAC	MS 383.5.12-24VAC/DC

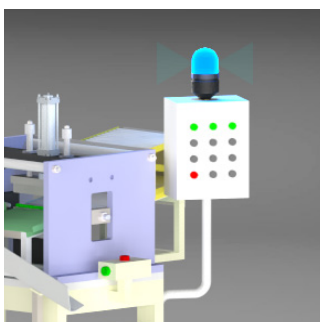

Warning Beacons

700 Series Ø90 Warning Beacons

700 Series



- Various light options
- Optimized fresnel lens for perfect light distribution
- Wall, Base, Ceiling mounting easy assembly
- For industrial and general applications
- PC lens, ABS housing
- Optional photosensor for light to turn on automatically at dusk
- Optional buzzer

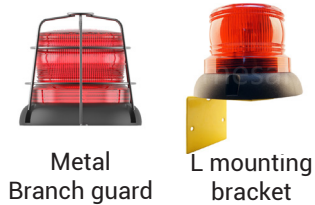
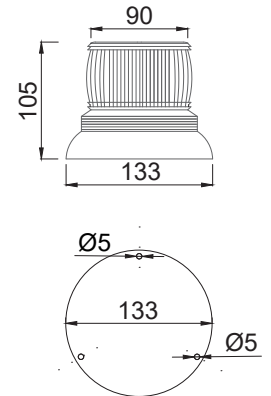

Model	Light	Specs	Mounting
706	Bulb Blinking	-	Base mount
713	Bulb Blinking	Buzzer	L bracket
702	Bulb permanent E14 10W	-	Base mount
726	LED Blinking	Buzzer	L bracket
720	LED Blinking	Photosensor	Base mount
730	LED Blinking	2 sided	L bracket
725	LED Multifunction	Buzzer	L bracket
729	LED Multifunction	-	L bracket
711	Rotator Mechanical BA15S 10W	-	Base mount
710	Rotator Mechanical BA15S 10W	-	Magnetic mount with cigarette plug
712	Rotator Mechanical BA15S 10W	-	L bracket
715	Rotator Mechanical BA15S 10W	Buzzer	L bracket
743	SMD LED Tower	-	Base mount
742	SMD LED Tower	Buzzer	Base mount
752	SMD LED Tower	Buzzer 43 tone	Base mount
744	SMD LED w/out Reflector	-	Base mount
734	SMD LED with Reflector	-	Base mount
739	SMD LED with Reflector	-	Magnetic mount
733	SMD LED with Reflector	-	Magnetic mount with cigarette plug
738	SMD LED with Reflector	Buzzer	Magnetic mount with cigarette plug
703	Xenon strobe 2 flash	-	Base mount
723	Xenon strobe 2 flash	-	Magnetic mount
709	Xenon strobe 2 flash	-	Magnetic mount with cigarette plug
704	Xenon strobe 2 flash	-	Pipe mount
705	Xenon strobe 2 flash	-	L bracket
708	Xenon strobe 2 flash	Buzzer	L bracket
701	Xenon strobe 2 flash	Photosensor	Base mount
700	Xenon strobe 9 flash	-	Base mount

HOW TO ORDER

MS . .
 [MODEL] [VOLTAGE]

- 1 - red
- 2 - green
- 3 - amber
- 4 - white
- 5 - blue

Voltage Chart			
Bulb Permanent	Bulb Blinking / Rotator BA15S 10w	Xenon Strobe	LED Multifunction
12VDC	12VDC	24VAC/DC	12-24VAC/DC
24VDC	24VDC	110VAC	110-220VAC
110VAC	220VAC	220VAC	12-60VAC/DC
220VAC			85-260VAC

Warning Beacons

600 Series Ø110 Warning Beacons

600 Series

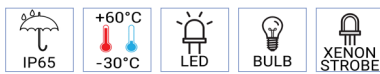

- Various light options
- Optimized fresnel lens for perfect light distribution
- Wall, Base, Ceiling mounting easy assembly
- For industrial and general applications
- PC lens, ABS housing
- Optional photosensor for light to turn on automatically at dusk
- Optional buzzer

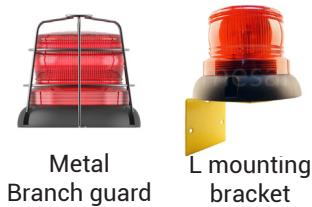
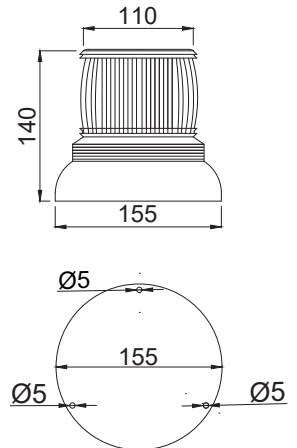

Model	Light	Specs	Mounting
606	Bulb Blinking	-	Base mount
614	Bulb Blinking	Buzzer	L bracket
602	Bulb permanent E14 10W	-	Base mount
635	LED Multifunction	Buzzer	L bracket
641	LED Blinking	2 sided	L bracket
631	LED Blinking	-	Base mount
634	LED Blinking	Photosensor	Base mount
646	LED Rotator Tetragonal	30 LEDs	Base mount
647	LED Rotator Hexagonal	43 LEDs	Base mount
612	Rotator Infinite Screw system BA15S 21W 24V 12V	-	Base mount
611	Rotator Mechanical BA15S 10W	-	Base mount
620	Rotator Mechanical BA15S 10W	-	Magnetic mount with cigarette plug
650	Rotator Mechanical BA15S 10W	-	L bracket
616	Rotator Mechanical BA15S 10W	Buzzer	L bracket
655	SMD LED Multi Tower	-	Base mount
660	SMD LED with Reflector	-	Base mount
633	SMD LED w/out Reflector	-	Base mount
630	SMD LED Multifunction	-	Magnetic mount with cigarette plug
603	Xenon strobe 2 flash	-	Base mount
638	Xenon strobe 2 flash	-	Magnetic mount
609	Xenon strobe 2 flash	-	Magnetic mount with cigarette plug
639	Xenon strobe 3 flash	-	Magnetic mount with cigarette plug
604	Xenon strobe 2 flash	-	Pipe mount
605	Xenon strobe 2 flash	-	L bracket
608	Xenon strobe 2 flash	Buzzer	L bracket
601	Xenon strobe 2 flash	Photosensor	Base mount
600	Xenon strobe 9 flash	-	Base mount
652	Xenon strobe 9 flash	-	Pipe mount

HOW TO ORDER

MS . .
[MODEL] [VOLTAGE]

- 1 - red
- 2 - green
- 3 - amber
- 4 - white
- 5 - blue

Voltage Chart			
Bulb Permanent	Bulb Blinking / Rotator BA15S 10w	Xenon Strobe	LED Multifunction
12VDC	12VDC	24VAC/DC	12-24VAC/DC
24VDC	24VDC	110VAC	110-220VAC
110VAC	220VAC	220VAC	12-60VAC/DC
220VAC			85-260VAC

Warning Beacons

800 Series Ø110 Warning Beacons

800 Series

- Various light options
- Optimized lens for perfect light distribution
- Wall, Base, Ceiling mounting easy assembly
- For industrial and general applications
- PC lens, ABS housing

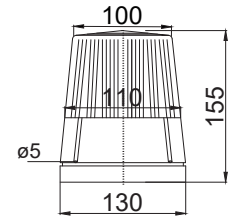

Pipe mount order no: 110 L mount bracket order no: 16



Magnet order no: 17 Cigarette Plug 6m order no: 11

HOW TO ORDER

MS 886 . 1 . 24VDC

- [MODEL] **1** - red [VOLTAGE]
- 2** - green
- 3** - amber
- 4** - white
- 5** - blue

Model	Light	Specs	Mounting
886	Bulb Blinking E27 25W	-	Base mount
894	Bulb Blinking E27 25W	Buzzer	Base mount
833	Bulb Blinking E27 25W	photosensor	Base mount
831	Bulb Blinking E27 25W	Buzzer	L bracket
881	Bulb permanent E27 25W	-	Base mount
837	Bulb permanent E27 25W	photosensor	Base mount
847	LED Blinking	Buzzer	Magnetic mount
861	LED Blinking	Buzzer	L bracket
830	LED Blinking	64LED	Base mount
850	LED Blinking	95LED	Base mount
834	LED Blinking	photosensor	Base mount
832	LED Multifunction	-	Base mount
858	LED Multifunction	Buzzer	Magnetic mount
887	LED Multifunction	-	Pipe mount
898	LED Multifunction	Buzzer	Magnetic mount
863	LED Multifunction	Buzzer	Base mount with branch guard
862	LED Multifunction	Buzzer	Base mount 3 screws
804	LED Rotator Tetragonal	30 LEDs	Base mount
805	LED Rotator Hexagonal	43 LEDs	Base mount
859	Rotator 24VDC 21W Halogen	-	Magnetic mount
853	Rotator BA15S 10W	-	Magnetic mount
895	Rotator BA15S 10W	-	Base mount
891	Rotator Infinite Screw system BA15S 21W 24V 12V	-	Base mount
838	Rotator Mechanical	Buzzer	Base mount
865	Rotator Mechanical	-	Base mount 3 screws
840	Rotator Mechanical	Buzzer	Base mount 3 screws
899	Rotator Mechanical BA15S 21W	Buzzer	L bracket
892	Rotator Metal Reflector H3 12 VDC 35W	-	Magnetic mount with cigarette plug
896	Rotator Metal Reflector H3 12 VDC 35W	-	Base mount
885	Xenon strobe 2 flash	-	L bracket
883	Xenon strobe 2 flash	-	Base mount
889	Xenon strobe 2 flash	-	Base mount with branch guard
893	Xenon strobe 2 flash	Buzzer	Base mount with branch guard
835	Xenon strobe 2 flash	photosensor	Base mount
844	Xenon strobe 2 flash	Buzzer	Base mount
888	Xenon strobe 2 flash	Buzzer	L bracket
839	Xenon strobe 2 flash	-	Magnetic mount
843	Xenon strobe 2 flash	-	Magnetic mount with cigarette plug
800	Xenon strobe 9 flash	-	Base mount

Voltage Chart

Bulb Permanent	Bulb Blinking / Rotator BA15S 10w	Xenon Strobe	LED Multifunction
24VDC	12VDC	24VAC/DC	12-24VAC/DC
110VAC	24VDC	110VAC	110-220VAC
220VAC	220VAC	220VAC	12-60VAC/DC
			85-260VAC

Warning Beacons

900 Series Ø135 Warning Beacons

900 Series

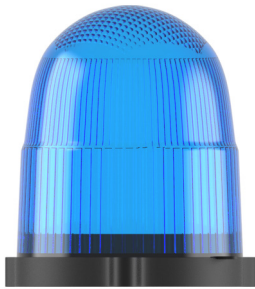

- Various light options
- Optimized fresnel lens for perfect light distribution
- Wall, Base, Ceiling mounting easy assembly
- For industrial and general applications
- PC lens, ABS housing
- Optional photosensor for light to turn on automatically at dusk
- Optional buzzer
- Optional mounting parts

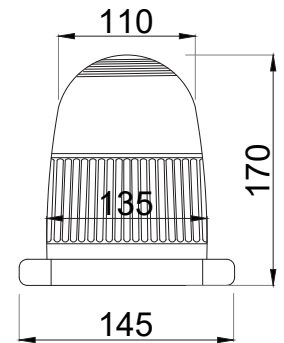

Model	Light	Specs	Mounting
902	Bulb blinking E27 25W	-	Base mount
903	Bulb blinking E27 25W	Photosensor	Base mount
901	Bulb permanent E27 25W	-	Base mount
9001	LED blinking	95 LED	Base mount
9003	LED blinking	95 LED Photosensor	Base mount
911	LED permanent	95 LED	Base mount
917	Rotator 24VDC 21W Halogen		Base mount
920	Rotator BA15S 10W	-	Magnetic mount with cigarette plug
921	Rotator BA15S 10W	-	Base mount
918	Rotator Infinite Screw system BA15S 21W 24V 12V		Base mount
925	Rotator Metal Reflector H3 12 VDC 35W		Base mount
904	SMD LED 3 function	-	Base mount
922	Xenon strobe 2 flash	Photosensor	Base mount
927	Xenon strobe 2 flash		Base mount
907	Xenon strobe 2 flash	Buzzer	L mount
908	Xenon strobe 2 flash	11-110VDC	Base mount
9002	Xenon strobe 2 flash	11-110VDC	Base mount
909	Xenon strobe 2 flash	Photosensor	Base mount
900	Xenon strobe 9 flash	-	Base mount
906	Xenon super 3 strobe	-	L mount
914	Xenon super 3 strobe	-	Pipe mount



Pipe mount
order no: 110



L mount bracket
order no: 16



Branch guard
metal order no:
970000900

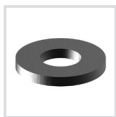

Magnet
order no: 17



Cigarette
Plug 6m
order no: 11

HOW TO ORDER

MS . .

[MODEL] ① - red [VOLTAGE]

 ② - green

 ③ - amber

 ④ - white

 ⑤ - blue

Voltage Chart

Bulb Permanent	Bulb Blinking / Rotator BA15S 10W	Xenon Strobe	LED Multifunction
24VDC	24VDC	24VAC/DC	12-24VAC/DC
110VAC	220VAC	110VAC	110-220VAC
220VAC		220VAC	12-60VAC/DC
			85-260VAC

Warning Beacons

8000 Series Ø140 Warning Beacons

8000 Series

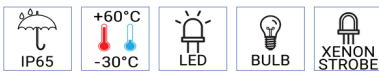

- Various light options
- Optimized lens for perfect light distribution
- Wall, Base, Ceiling mounting easy assembly
- For industrial and general applications
- PC lens, ABS housing
- Optional photosensor for light to turn on automatically at dusk
- Optional buzzer

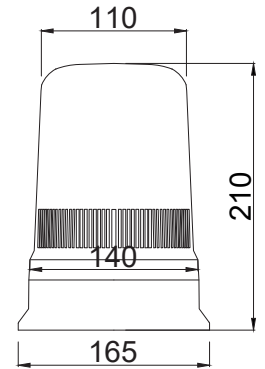

Pipe mount order no: 110



L mount bracket order no: 16



Branch guard metal order no: 9700008000



Magnet order no: 17



Cigarette Plug 6m order no: 11

Model	Light	Specs	Mounting
8903	Bulb blinking E27 25W	-	Base mount
8904	Bulb blinking E27 25W	Photosensor	Base mount
8902	Bulb permanent E27 25W	-	Base mount
8001	LED Blinking	-	Base mount
8003	LED Blinking	Photosensor	Base mount
8004	LED Multifunction	-	Base mount
8924	LED Multifunction	Buzzer	Base mount
8050	LED Rotator Hexagonal	43 LEDs	Base mount
8926	LED Rotator	Solar	Base mount
8923	Rotator BA15S 10W	-	Base mount
8925	Rotator BA15S 10W	-	Magnetic mount
8918	Rotator BA15S 10W	Buzzer	Base mount
8932	Rotator BA15S 10W	-	Pipe mount
8901	Rotator Infinite Screw system BA15S 21W 24V 12V	-	Base mount
8920	Rotator Metal Reflector H3 12 VDC 35W	-	Base mount
8922	Rotator Metal Reflector H3 12 VDC 35W	-	Pipe mount
8910	Rotator synchronous motor only 220VAC	-	Base mount
8005	SMD LED	-	Base mount
8905	Xenon strobe 2 flash	-	Base mount
8929	Xenon strobe 2 flash	Battery + Photosensor	Pipe mount
8907	Xenon strobe 2 flash	Branch guard	Base mount
8906	Xenon strobe 2 flash	Photosensor	Base mount
8908	Xenon strobe 2 flash	Buzzer	L Bracket
8912	Xenon strobe 2 flash	Buzzer	Base mount
8000	Xenon strobe 9 flash	-	Base mount

HOW TO ORDER

MS 8000 . 1 . 12VDC

[MODEL] [VOLTAGE]

- ① - red
- ② - green
- ③ - amber
- ④ - white
- ⑤ - blue

Voltage Chart			
Bulb Permanent	Bulb Blinking / Rotator BA15S 10W	Xenon Strobe	LED Multifunction
24VDC	12VDC	24VAC/DC	12-24VAC/DC
110VAC	24VDC	110VAC	110-220VAC
220VAC	220VAC	220VAC	12-60VAC/DC
			85-260VAC

1333 Heavy Duty Warning beacon with Loud Siren



- Bright Blinking LED 360 visibility
 - Multi Tone Loud siren 130dB sound output
 - Metal branch guard for lens protection
 - Corrosion and heat resistant body
 - Aluminum Diecast housing, metal siren, PC lens
 - Special junction box and brass PG cable gland
 - Optimized fresnel lens for perfect light distribution
 - Wall and base mounting
 - For industrial and heavy duty applications
- Heavy industry, shipyard, iron and steel production, ship loading machines, crane application areas

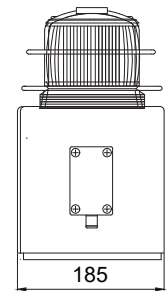
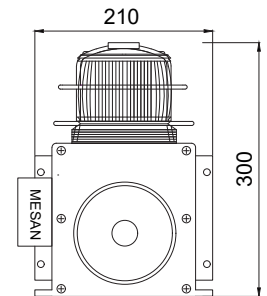

1333		
Tone	3	43
Specs	External Contact	
Voltages	12VDC 220VAC	12-60VDC/AC 110-220VAC

HOW TO ORDER

MS . .

[MODEL] [COLOR] [VOLTAGE]

① - red ② - green ③ - amber ④ - white ⑤ - blue



1334/1336 Heavy Duty Loud Siren



1334



1336 front view



1336

- Multi tone loud siren 130dB sound output
 - Connection box included for easy connection
 - Wall and Base mounting
 - For industrial and heavy duty applications
 - Aluminum diecast housing, metal siren
 - Special junction box and brass PG cable gland
 - For industrial and heavy duty applications
- Heavy industry, shipyard, iron and steel production, ship loading machines, crane application areas

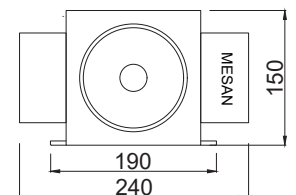
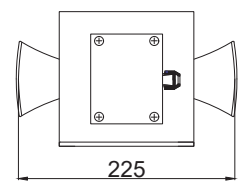
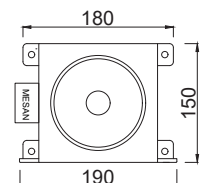

1334 Single Siren				
Mounting:	Wall and Base			
IP	IP66			
Tone	3		43	
Specs	External Contact			
Voltages:	12VDC	220VAC	12-60VDC/AC	110-220VAC
Order no:	MS 1334.12VDC	MS 1334.220VAC	MS 1334.12-60VDC/AC	MS 1334.110-220VAC

1336 Double Siren				
Mounting:	Base			
IP	IP65			
Tone	3		43	
Specs	External Contact			
Voltages:	12VDC	220VAC	12-60VDC/AC	110-220VAC
Order no:	MS 1336.12VDC	MS 1336.220VAC	MS 1336.12-60VDC/AC	MS 1336.110-220VAC

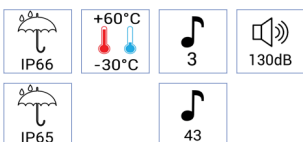

Forklift Warning Beacons

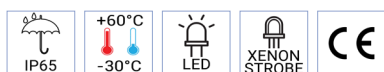

HOW TO ORDER

MS . .
 [MODEL] [Color] [VOLTAGE]

- 1 - red 2 - green 3 - amber
- 4 - white 5 - blue

- Wide voltage range suitable for forklifts and other mobile vehicles
- Various light options
- Optimized fresnel lens for perfect light distribution
- Base mounting easy assembly
- For industrial and general applications
- PC lens, ABS housing

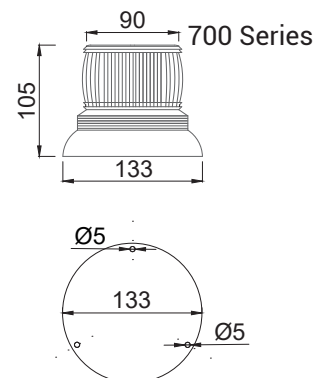

Model	Light	Voltage	Mounting
731	Xenon strobe 2 flash	11-110VDC	Base mount
732	Xenon strobe 2 flash	11-110VDC	Magnetic mount
740	Xenon strobe 2 flash	11-110VDC	Magnetic mount with cigarette plug
745	SMD LED with Reflector	11-110VDC	Base mount
749	SMD LED with Reflector	11-110VDC	Magnetic mount
733	SMD LED with Reflector	11-110VDC	Magnetic mount with cigarette plug
637	Xenon strobe 2 flash	11-110VDC	Base mount

451/481 Forklift Blue Spot / Red Beam Lights

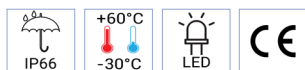

- Wide voltage range suitable for forklifts and other mobile vehicles
- Aluminum body
- Special fresnel lens for perfect light distribution
- Wall, Base, Ceiling mounting easy assembly with accessory included



Model	Type	Light	Color	Voltage	Mounting
451	Blue Spot Light	CREE LED	Blue spot	9-80VDC	Mounting accessory
481	Red Beam Light	CREE LED	Red beam	9-80VDC	Mounting accessory

Reversing Buzzer



121 1258
122 1260



HOW TO ORDER

MS .
 [MODEL] [VOLTAGE]

- Sound pressure can be reduced by ~10 dB via turning window(for buzzer)
- For 122 sound pressure can be reduced via internal potentiometer
- For industrial and general applications
- Sealed electronics, low current consumption

Model	121	122	1260	1258
Mounting:	Wall mounting	Wall mounting	Wall mounting	Wall mounting
Tone:	1 tone	43 tones	1 tone	43 tones
Tone:	Alternating	Various	Pulsed	Pulsed
Sound Output:	120dB	120dB	95dB	95dB
Dimensions:	70x70x98mm		70x76x90mm	
Current:	< 30 mA			
Voltages:	12-24VAC/DC 48VDC 48VAC 110VDC 110-220VAC	12-24VAC/DC 110-220VAC	3-24VAC/DC 24VAC/DC 48VAC/DC 110VAC/DC 220VAC/DC	24VAC/DC 220VAC/DC

1327/1328 Emergency Gathering Point Light and Siren



1327

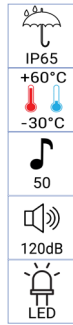

- Used for marking the gathering point or for direction
- Internal 12V battery for usability in power outage
- LED multifunction 360 visible
- M30 Pipe mount or wall mount
- Loud 50 tone siren
- PC and ABS, metal pipe mount
- Suitable for indoor/outdoor use



1328 mini

Order no:	Light	Tone
MS 1327	LED Multifunction	50 Tone
MS 1328	LED Multifunction	50 Tone
Voltages Available: 220VAC		

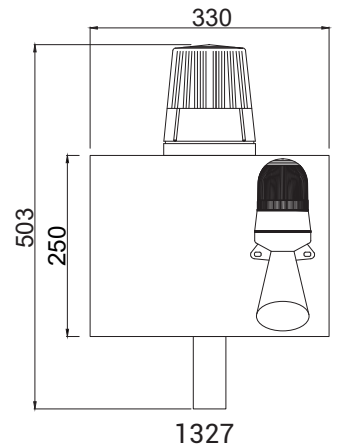

1330 Emergency Light and Siren



- Used for emergency / security situations
- LED multifunction 360 visible
- Branch lens cover
- Hang mount
- Loud 3 tone siren externally controlled
- 130dB
- External volume control
- Metal, PC and ABS
- Suitable for indoor/outdoor use

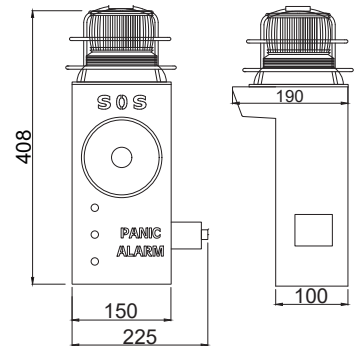

Order no:	Light	Tone
MS 1330	LED Multifunction	3
Voltages Available: 220VAC		

5809/5842 Emergency Light and Siren



5809

5842



- Used for emergency / security situations especially for cold storage rooms
- Internal 12V battery for usability in power outage it starts to work automatically in power cut
- Loud 120dB Electronic Siren
- LED multifunction 360 visible(5809 model)
- External volume control
- For general applications
- PC and ABS
- Suitable for indoor/outdoor use
- Dimensions: 113X143x210mm



cold storage rooms

Order no:	Light	Tone
MS 5809	LED Multifunction	2
MS 5842	-	2
Voltages Available: 220VAC		

5900/5901 LED Flashing Solar Warning Beacon



5900

5901

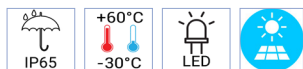

- Commonly used for flag poles
- PC lens, ABS
- Optimized reflector lens for perfect light distribution
- Red color
- Wall, Base, Ceiling mounting easy assembly
- For general applications

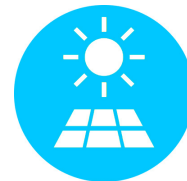

Model	Light	Color	Mounting	Dimensions
5900	LED	Red	Mounting accessory	95x35x215mm
5901	LED	Red	Mounting accessory	85x95x165mm

150 LED Flashing Solar Warning Beacon

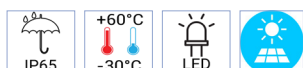

- Bright LED and excellent reflector
- PC and ABS
- Optimized reflector lens for perfect light distribution
- Red color
- Base mounting easy assembly
- For general applications

Model	Light	Color	Mounting	Dimensions
150	LED	Red	Mounting accessory	100x100x180mm

618/627 LED Multifunction Solar Warning Beacon

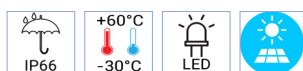

Pipe mount
order no: 110



L mount bracket
order no: 16



Magnet
order no: 17

- 16pcs Bright SMD LED
- Multifunction LED patterns or flashing
- PC and ABS
- 2200mAH Battery
- Optimized fresnel lens for perfect light distribution

Model	Light	Color	Mounting
627	Multifunction	16pcs SMD LED	Base
618	Flashing	12pcs 10mm LED	Base

HOW TO ORDER

MS .
[MODEL] [COLOR]

- 1 - red
- 2 - green
- 3 - amber
- 4 - white
- 5 - blue

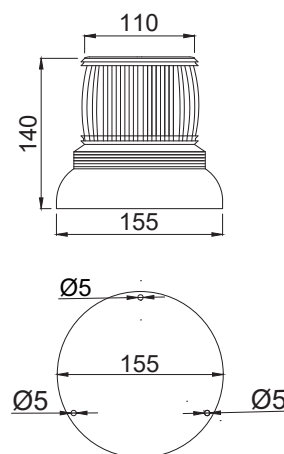

8933 LED Multifunction Solar Warning Beacon with pipe mount

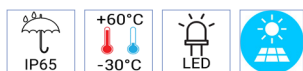

- 24pcs Bright 10mm LED
- Flashing LED
- PC and ABS
- 2200mAH Battery
- Optimized lens for perfect light distribution
- Pipe mount

Model	Signal	Light	Mounting
8933	Flashing	12pcs 10mm Bright LED	Pipe

HOW TO ORDER

MS .
[MODEL] [COLOR]

- 1 - red
- 2 - green
- 3 - amber
- 4 - white
- 5 - blue

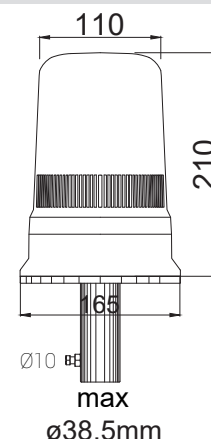

500 Series



- Rechargeable LED Warning Beacons
- PC lens and ABS base
- Buzzer is optional
- Hang mount
- 12V 1.3A Battery included
- Durable structure
- Charge adapter is sold separately (3320)

Model	Light	Specs	Size	Mounting
500	Bulb permanent 10W	-	Tall	Hang
501	Bulb blinking	-	Tall	Hang
502	Xenon strobe 2 flash	-	Tall	Hang
504	LED blinking	-	Tall	Hang
505	LED blinking	photosensor	Tall	Hang
507	LED rotator	-	Tall	Hang
508	Rotator mechanical	photosensor	Tall	Hang
511	Bulb permanent 10W	-	Short	Hang
512	Bulb blinking	-	Short	Hang
513	Xenon strobe 2 flash	-	Short	Hang
514	Xenon strobe 2 flash	photosensor	Short	Hang
515	Multifunction LED	-	Short	Magnetic Base + Hang
516	LED Blinking	photosensor	Short	Hang
517	Rotator mechanical	buzzer	Short	3 screws
518	Rotator mechanical	-	Short	3 screws
519	Xenon strobe 2 flash	buzzer	Short	3 screws
594	Multifunction SMD LED with reflector	buzzer	Short	3 screws
595	Rotator mechanical	buzzer	Short	3 screws
596	LED Blinking	buzzer	Short	3 screws
597	Multifunction LED	buzzer	Short	3 screws
598	Multifunction LED	-	Short	3 screws + Hang

Model	Light	Specs	Mounting
591	LED multifunction on off button, polyamid base, buzzer		Base
592	LED multifunction on off button buzzer		Hang
3320	30W Charge adapter		

- Rechargeable LED Warning Beacons
- Buzzer is optional
- Magnetic base
- 12V 1.3A Battery included
- Durable structure, PC lens ABS base
- Charge adapter is sold separately (3320)

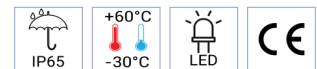

Rechargeable Warning Light				
Model	Light	Specs	Mounting	
6607	Rechargeable LED Multifunction on-off	-	magnetic mount	
6608	Rechargeable LED Multifunction on-off	buzzer	magnetic mount	
1412	Rechargeable LED Multifunction on-off	buzzer	magnetic mount	
1390	Rechargeable LED Multifunction on-off	-	magnetic mount	
1391	Rechargeable LED Multifunction on-off	buzzer	magnetic mount	
3320	30W Charge adapter			

Ø70 Mini LED Traffic Lights

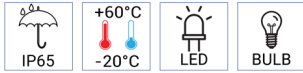

	Light	Specs	Color	110-220VAC	12-24VDC
2 Tier	SMD LED	Multifunction	Red	MS 8045.1.2.110-220VAC	MS 8045.1.2.12-24VDC
	Bulb	Permanent	Green	MS 8055.1.2.110-220VAC	MS 8055.1.2.12-24VDC
3 Tier	SMD LED	Multifunction	Red	MS 8044.1.3.2.110-220VAC	MS 8044.1.3.2.12-24VDC
	Bulb	Permanent	Yellow Green	MS 8054.1.3.2.110-220VAC	MS 8054.1.3.2.12-24VDC

Multifunction modes: 3 flash, blinking, permanent

Dimensions:
2 Tier: 75x140x230mm
3 Tier: 75x140x350mm

Ø100 LED Traffic Lights

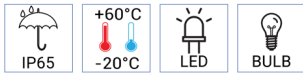

	Light	Specs	Color	220VAC	24VDC
1 Tier	SMD LED	Multifunction	Red Yellow Green	MS 8013.○.220VAC	MS 8013.○.24VDC
	Bulb	Blinking		MS 8011.○.220VAC	MS 8011.○.24VDC
	Bulb	Permanent		MS 8010.○.220VAC	MS 8010.○.24VDC
	SMD LED	Multifunction + Buzzer		MS 8019.○.220VAC	MS 8019.○.24VDC
2 Tier	SMD LED	Multifunction	Red Green	MS 8025.1.2.220VAC	MS 8025.1.2.24VDC
	Bulb	Blinking		MS 8018.1.2.220VAC	MS 8018.1.2.24VDC
	Bulb	Permanent		MS 8017.1.2.220VAC	MS 8017.1.2.24VDC
	SMD LED	Multifunction + Buzzer		MS 8048.1.2.220VAC	MS 8048.1.2.24VDC
3 Tier	SMD LED	Multifunction	Red Yellow Green	MS 8027.1.3.2.220VAC	MS 8027.1.3.2.24VDC
	Bulb	Blinking		MS 8029.1.3.2.220VAC	MS 8029.1.3.2.24VDC
	Bulb	Permanent		MS 8026.1.3.2.220VAC	MS 8026.1.3.2.24VDC

Dimensions:

1 Tier: 175x10x140mm
2 Tier: 175x10x370mm
3 Tier: 175x10x550mm

① - red ② - green ③ - amber Multifunction modes: 3 flash, blinking, permanent

Ø200 Power LED Traffic Lights

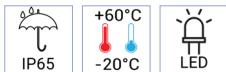

	Color	220VAC	24VDC
1 Tier	Red	MS 8032.1.220VAC	MS 8032.1.24VDC
	Green	MS 8032.2.220VAC	MS 8032.2.24VDC
	Yellow	MS 8032.3.220VAC	MS 8032.3.24VDC
2 Tier	Red-Green	MS 8035.1.2.220VAC	MS 8035.1.2.24VDC
3 Tier	Red-Yellow-Green	MS 8047.1.3.2.220VAC	MS 8047.1.3.2.24VDC

1 Tier: 280x180x400mm
2 Tier: 280x180x675mm
3 Tier: 280x180x960mm

Ø300 Power LED Traffic Lights

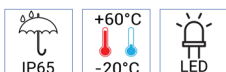

	Color	220VAC	24VDC
1 Tier	Red	MS 8042.1.220VAC	MS 8042.1.24VDC
	Green	MS 8042.2.220VAC	MS 8042.2.24VDC
	Amber	MS 8042.3.220VAC	MS 8042.3.24VDC
2 Tier	Red-Green	MS 8043.1.2.220VAC	MS 8043.1.2.24VDC
3 Tier	Red-Amber-Green	MS 8049.1.3.2.220VAC	MS 8049.1.3.2.24VDC

1 Tier: 360x190x485mm
2 Tier: 360x190x740mm
3 Tier: 360x200x1270mm

Solar LED Traffic Lights



- No need external power, no need wiring.
- Energy saving. Low-power, solar cell, low cost
- Environmental. No harmful substance, no pollutant.
- PC and ABS durable material
- Bright LED

HOW TO ORDER

MS .
 [MODEL] [COLOR]

- 1 - red
- 2 - green
- 3 - amber

Diameter	Light	Specs	Model
Ø200	LED	Solar	8038
Ø300	LED	Solar	8039

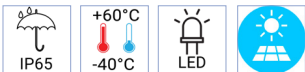

8008/8009 Garage Warning Light



- Suitable for private garage entrances

Light	Specs	220VAC
LED	Permanent	MS 8008.1.2.220VAC
Bulb	Permanent	MS 8009.1.2.220VAC

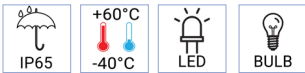

159 Solar Road Stud



- Solar Road Stud also know as cat eyes, can help to reduce accident at regional rail crossing, intersection and provide guidance and hazard warning to drivers in darkness and bad weathers.
- Can handle up to 40tons

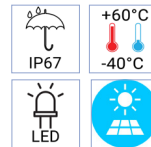

Light	Specs	Color	Model
LED	Flashing	red	MS 159.1
		yellow	MS 159.3

8056 4 Side Mini Traffic Light



- 4 Sided traffic light
- All application
- Waterproof
- LED Multifunction
- Suitable for schools, playgrounds, amusement parks

Light	Specs	
LED	Multifunction	MS 8056.1.2.220VAC
LED	Multifunction	MS 8056.1.2.24VDC

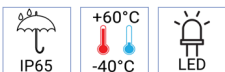

8023 Rotatable Traffic Light



- Can rotate 360° horizontally
- Can rotate 180° vertically

Light	Specs	
LED	Multifunction	MS 8056.0.220VAC

- 1 - red
- 2 - green
- 3 - amber

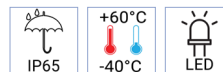

1353 Mini Strobe Light



- Red light flashing + xenon strobe
- Internal photosensor
- All application
- Waterproof
- D type 1,5V Battery (not included)
- 40x40x121mm

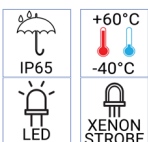

1220 LED Baton



- 10pcs bright LED
- Works with 2 pcs D sized 1.5V battery(not included)
- Permanent and flashing modes
- Red color
- ABS
- 40x40x540mm

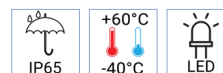

Why Obstruction Lights are used?



According to law buildings of a specific height and in the vicinity of airports as well as factory chimneys, towers, poles, cranes, power lines etc. must be equipped with obstruction lights.

Obstruction lighting is one of the most important aspects of flight safety and is also the most efficient. This special lighting makes obstacles visible for pilots in the dark or when visibility is poor.

The ICAO regulations regarding the methods of marking and lighting aviation obstacles can be found in ICAO Annex 14.

We as Mesan Electric has developed and continue to improve our products for flight safety with our 45+years of experience in this field. We developed, together with main actors of Telecom, Building and Energy sectors, tailored business cases for design strategies that have met all expectations and needs. We provide low cost and also high end products for users.



Aluminum Base



1350

Armed lights with Junction Box

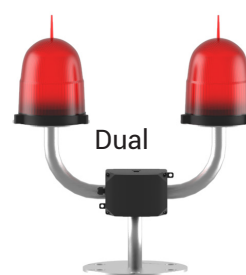

1325



1342

Plastic Base



1321/1322/1323



1335

Models with Back Up Battery for power outage



1310



1311

Steel Base



1320



1362



Pipe mount
order no: 117



Wall mount
bracket order
no: 118



Mounting bracket
order no: 119

- Steel: high strength-low alloy, galvanized oven painted in industrial paint baking oven

Low Intensity Obstruction Lights

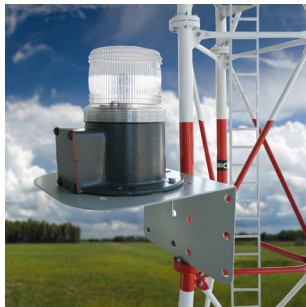

- Compliance with ICAO ANNEX 14 and FAA
- Automatic day and night switch
- 360° visibility
- Low power consumption
- up to 50.000h LED lifetime
- Easy installation
- Wide range power supply
- Resistance to corrosion
- PC Lens and ABS, Steel, aluminum housing options
- Integrated sensors in the light are able to detect when the ambient light threshold drops sufficiently and the light will begin operation automatically
- The light fixture incorporates internal diagnostic checking and an alarm contact for remote monitoring(Alarm contacts)

Model	Light Source	Light Intensity	Color	Effect	Body	Voltages	Specs	Backup Light Main + Standby	Optional	
									Alarm Contacts	GPS Synch
1321	Xenon	>32cd	Red	Flash	ABS	48VDC	CE	✓	✓	-
1322	Xenon	>32cd	Red	Flash	ABS	220VAC	CE	✓	✓	-
1323	Xenon	>32cd	Red	Flash	ABS	24VDC	CE	✓	✓	-
1335	LED	>32cd	Red	Flash	ABS	48VDC 220VAC	CE	✓	✓	-
1320	LED	>200cd	Red	Flash	Steel	18-65VDC 220VAC	CE	-	-	-
1362	LED	>400cd	Red	Flash	Steel	220VAC		-	-	-
1325	LED	>32cd	Red	Flash/ Permanent	ABS/ Steel	15-60VDC 85-265VAC	Dual w/ arm	CE	✓	✓
1342	LED	>32cd	Red	Flash/ Permanent	ABS/ Steel	15-60VDC 85-265VAC	w/ arm	CE	✓	✓
1310	Xenon	>32cd	Red	Flash	ABS	220VAC	Battery		✓	✓
1311	Xenon	>32cd	Red	Flash	ABS	220VAC	Battery		✓	✓
1350	LED	>200cd	Red	Flash/ Permanent	Aluminum	15-60VDC 85-265VAC		CE	✓	✓

Solar Obstruction Lights



1292



151

- High-performance solar modules angled to maximize solar collection
- Self-contained solar powered obstruction light with integrated solar/battery system.
- Saves time and maintenance costs
- Steel: high strength-low alloy, galvanized oven painted in industrial paint baking oven
- Aluminum Diecast: painted in industrial paint baking oven

Model	Light Source	Light Intensity	Color	Effect	Body Options	Specs
1292	LED	>32cd	Red	Flash	Aluminum Diecast	RF Remote Control
					Steel	
151	LED	>32cd	Red	Flash	Steel	

Dimensions:

1292: 420 x 330 x 190mm

151: 480 x 430 x 600 mm



Medium Intensity Obstruction Light

new



- Compliance with ICAO ANNEX 14
- Automatic day and night switch
- 360° visibility
- up to 50.000h LED lifetime
- Easy installation
- Wide range power supply
- PC Lens and Aluminum die cast body resistance to corrosion
- Integrated sensors in the light are able to detect when the ambient light threshold drops sufficiently and the light will begin operation automatically

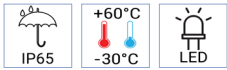

Model	Type	Light Source	Light Intensity	Color	Signal Effect	Voltages	Backup Light Main + Standby	Optional	
								Alarm Contacts	GPS Synch
1365	Type B	CREE LED	2000cd ±25%	Red (Night)	Flash	85-245VAC 48VDC	-	-	✓
1366	Type B	CREE LED	2000cd ±25%	Red (Night)	Flash	85-245VAC 48VDC	✓	✓	✓
1367	Type A&B	CREE LED	20000cd ±25% 2000cd ±25%	White (Daytime) Red (Night)	Flash	85-245VAC 48VDC	-	-	✓
1368	Type A	CREE LED	20000cd ±25% 2000cd ±25%	White (Daytime) White (Night)	Flash	85-245VAC 48VDC	-	-	✓



Pipe mount
order no: 117



Wall mount
bracket order
no: 118



Mounting bracket
order no: 119



Obstruction Lights

Anhang Technology and Mesan Electric Co. is a specialized enterprises focusing on research, production, sales and after-sales service of aviation obstruction light, aircraft warning light, helipad lighting, solar airfield lights, marine navigation lanterns. Our company headquarter is in Hong Kong and have more than 10 years manufacturing experience for clients from whole world. Our products are patented and also have passed CE, ICAO, ISO9001, etc. All aviation obstruction light, aircraft warning lights, helipad lighting, solar airfield lights are fully complied with standards of ICAO, FAA, CAAC. All marine navigation lanterns are fully complied with standards of IALA.



Mini Low Intensity
MS 2000



Solar Low Intensity
MS 2014



Medium Intensity



Solar Medium Intensity
MS 2015
MS 2016



High Intensity
MS 2006



LED Solar Powered
Marine Lantern
MS 2007
MS 2011



LED Solar Powered
Marine Lantern MS
2008
MS 2009



Solar Airport
Light
MS 2012



Solar Airport
Light
MS 2013



Light Controller
MS 2010

	Model		Light Source	Light Intensity	Color	Effect	Voltages	Dimensions (mm)
Low Intensity	MS 2000	AH-LI-B2	CREE LED	≥32cd	Red (Night)	Steady, 20-60fpm	within same unit 48VDC 110-240VAC	90×90×130
	MS 2014	AH-LS-L					SOLAR	162×162×160
Medium Intensity	MS 2003	AH-MI-A2	CREE LED	≥20000cd ≥2000cd	White	20-60fpm	48VDC or 110-240VAC	229×229×168
	MS 2001	AH-MI-B2	CREE LED	≥2000cd	Red (Night)	20-60fpm		229×229×168
	MS 2004	AH-MI-C2	CREE LED	≥2000cd	Red (Night)	Steady		229×229×168
	MS 2002	AH-MI-AB	CREE LED	≥20000cd ≥2000cd	White (Daytime) Red (Night)	20-60fpm		229×229×168
	MS 2005	AH-MI-AC	CREE LED	≥20000cd ≥2000cd	White (Daytime) Red (Night)	Day: 20-60fpm Night: Steady	229×229×168	
	MS 2015	AH-MS-B3	CREE LED	≥2000cd	Red (Night)	20-60fpm	SOLAR	450×320×300
	MS 2016	AH-MS-A1	CREE LED	≥20000cd ≥2000cd	White (Daytime) Red (Night)	20-60fpm	SOLAR	500×450×320
High Intensity	MS 2006	AH-HI-A0	CREE LED	≥200,000cd(Daytime) (ICAO) ≥270,000cd(Daytime) (FAA L-856) ≥20,000cd(Twilight) ≥2,000cd(Night)		40-60fpm	48VDC or 110-240VAC	510×196×245
Solar Marine	MS 2007	AH-LS-C	CREE LED	1-3NM (AT@0.74)	Red, Green, Amber, White, Blue	0.5S ON, 2.5S OFF	-	162×162×160
	MS 2008	AH-ML-S6	CREE LED	4-8NM(AT@0.74)		Adjustable IALA 256 flash characters	-	250×250×320
	MS 2009	AH-ML-S0	CREE LED	8-11NM (AT@0.74)		-	-	250×250×480
	MS 2011	AH-LS-P2	CREE LED	6-15NM (AT@0.74)		-	-	220×220×233
S.Airfield Light	MS 2012	AH-SA-B	CREE LED	12cd		Steady	-	162×162×160
	MS 2013	AH-SA-A	CREE LED	35cd		Steady	-	250×250×340



Model	Body	Voltages	IP Rate	Dimensions
MS 2010 AH-OC-K2 Light Controller	Powder coated cold-roll steel	110VAC 240VAC 48VDC 12VDC	IP65	400×300×200

*fpm: Flash per minute

Helipad Lights



- LED as light source saving power consumption and maintenance
- 95% less power than equivalent incandescent light
- In compliance ICAO Annex 14 Volume Heliports 5.3.2
- In compliance FAA AC 150/5390-2B Heliport Design Guide



Inset Light
FATO & TLOF
MS 3000



LED Heliport
Flood Light
MS 3002



LED Heliport Beacon
MS 3003
MS 3005



Wind Cone with
Low Intensity
Obstruction Light
MS 3004



Light Controller
MS 3010

Model		Light Source	Light Intensity	Color	Effect	Body	Voltages	IP Rate	Dimensions
MS 3000	AH-HP-I	LED	≥100cd	Green, amber, white, blue	Permanent	Anodized Die-casting aluminum	48VDC 110-240VAC	IP68	194×194×138
MS 3002	AH-HP-F	LED	3084Lm 120°	White	Permanent	Aluminum alloy	24VDC 48VDC 110-240VAC	IP66	154×108×104
MS 3003	AH-HP-B1	LED	≥2500cd	White	Special	Powder-coated Die-casting aluminum	12-48VDC 110-240VAC	IP65	220×220×233
MS 3005	AH-SA-HP	LED	≥2500cd	White	Special		SOLAR	IP68	250×250×20

Model		Light Source	Light Intensity	Color	Effect	Body	Voltages	IP Rate	Dimensions
MS 3004	AH-HP-W1	LED	≥32cd	Red	Permanent	Stainless Steel	12-48VDC 110-240VAC	IP65	Below
		LED	3084Lm 120°	White	Permanent	Aluminum alloy			

An aerodrome shall be equipped with at least one wind cone as wind direction indicator.
The flood light for illumination is inside wind sock, it will rotate together with windssock too.
One obstruction light on top for aircraft warning.
Pole height: 4m, Length: 1.2m, big diameter: 300mm, small diameter: 150mm
Pole height: 4m-6m, Length: 2.4m, big diameter: 600mm, small diameter: 300mm
Pole height: 6m, Length: 3.6m, big diameter: 900mm, small diameter: 450mm

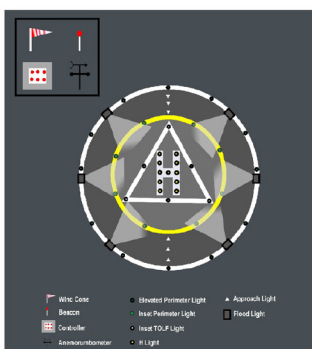

Model	Body	Voltages	IP Rate	Dimensions
MS 3010 AH-HP-G Light Controller	Powder coated cold-roll steel	110VAC 240VAC 48VDC 12VDC	IP65	400×300×200 mm

Explosion Proof Lighting Qinsun and Mesan



Qinsun and Mesan Electric Co. are cooperating since 2010. Shanghai Qinsun Electric Co., is high-tech enterprise base on independent innovation and combines R&D production and marketing in one. Qinsun is the most innovative company in the field of LED explosion proof lighting, and is regarded as innovator and leader in the same field. We are proud cooperating with Qinsun providing designs, tests and final certified products to our customers special needs.

What is Explosion Proof Lighting?

- Explosion-proof lighting works by ensuring ignition of the flammable airborne specks in the fixture keeping the remains contained inside. In a typical lighting fixture, the contacts, bulb, wiring and switches are exposed to the atmosphere. The spark from a movement of the switch, and even the heat of the bulb can be enough to create a flammable atmosphere. In a flammable proof lighting fixture, any explosion that may happen is contained inside of the fixture itself.



ATEX
Certificate



CNEX
Certificate



BLD230



BLD190



BLD150



GLD290H



BLD180



BLD530



BZD310



BJD330



BJD320

	Model		Light	Power	Lumen	Area Class	Certification	Voltages
High/Mid Bay	MS 1400.30W	BLD230-30W	LED	20W	3300lm	Zone:1,2,21,22	Ex CE	110-220VAC
	MS 1400.60W	BLD230-60W	LED	60W	6600lm	Zone:1,2,21,22		110-220VAC
	MS 1400.80W	BLD230-80W	LED	80W	8800lm	Zone:1,2,21,22		110-220VAC
	MS 1401.30W	BLD190-30W	LED	30W	3300lm	Zone:2,21,22	CNEX CE	110-220VAC
	MS 1401.40W	BLD190-40W	LED	40W	4400lm	Zone:2,21,22		110-220VAC
	MS 1402	BLD220	LED	20W	3300lm	Zone:1,2,21,22		110-220VAC
Flood Light	MS 1403.40W	BLD150-40W	LED	40W	4400lm	Zone:1,2,21,22	Ex CE	110-220VAC
	MS 1403.60W	BLD150-60W	LED	60W	6600lm	Zone:1,2,21,22		110-220VAC
	MS 1403.80W	BLD150-80W	LED	80W	8800lm	Zone:1,2,21,22		110-220VAC
	MS 1404.160W	BLD150-160W	LED	160W	16500lm	Zone:1,2,21,22		110-220VAC
Street Light	MS 1405.100W	GLD290-100W	LED	100W	12000lm	-	CE	110-220VAC
Linear Light	MS 1406	BLD180-18W	LED	18W	1800lm	Zone:2,21,22	CE	110-220VAC
	MS 1407.18W	BLD530-18W	LED	18W	900lm	Zone:1,2,21,22	Ex CE	110-220VAC
	MS 1407.36W	BLD530-36W	LED	36W	1800lm	Zone:1,2,21,22		110-220VAC
Emergency Exit Signal	MS 1410	BZD310	LED	3W	-	Zone:1,2,21,22	CE	110-220VAC
	MS 1408	BJD330	LED	10W	-	Zone:1,2,21,22	CE	110-220VAC
	MS 1409	BJD320	LED	6W	-	Zone:1,2,21,22	CE	110-220VAC



Mounting part
Order no: 99

Model	Light	Signal	Specs	Voltages	Dimensions(mm)
152	LED	Multi	Solar	Solar	200x200x460
1302	Bulb	Permanent		12VDC / 24VDC/ 220VAC	200x200x460
1303	Bulb	Blinking		12VDC / 24VDC/ 220VAC	200x200x460
1306	Xenon	2 flash		24VAC/DC / 220VAC	200x200x460
1308	LED	Blinking		24VDC / 220VAC	200x200x460
1389	LED	Multi		12-24VDC / 110-220VAC	200x200x460
Ex-Proof Obstruction Light					
1299	Xenon	2 flash	Backup	48VDC / 220VAC	200x200x460
1319	LED	Blinking	Backup	48VDC / 220VAC	200x200x460



Yeşilbayır Mah. Edirne - İstanbul
Demiryolu Cad. No:46 Hadımköy
Arnavutköy / İstanbul
Tel: 0 (212) 771 29 44-45 Fax: 0 (212) 771 29 48
info@mesanelektrik.com
www.mesanelektrik.com

