

Catalogo generale
Sistemi di protezione per cavi elettrici
General catalogue
Protection systems for electric cables



Introduzione

Settori d'impiego	Product Applications	4
Filettature	Threads	6
Riferimenti normativi	Legal reference	8
Temperatura di Esercizio	Operating temperature	16
Resistenza agli agenti chimici	Resistance to chemical agents	18
Grado di protezione IP	IP Protection Degree	20

Introduction

Sistemi metallici

Campi di applicazione	Fields of application	23
Caratteristiche tubi	Conduits characteristics	24
Guaina metallica	Flexible / Pliable conduit	26
Tubo pieghevole	Pliable conduit	46
Calza	Sleeve	48
Tubo flessibile PVC	PVC flexible conduit	49
Raccordi per tubi metallici flessibili e pieghevoli	Fittings for flexible and pliable metal conduits	54
Raccordi pressacavo	Gland fittings	63
Raccordi plastici	Plastic fittings	70
Accessori	Accessories	74
Tubo rigido	Rigid conduit	76
Raccordi a innesto rapido	Quick coupling fittings	80
Raccordi a innesto rapido in acciaio AISI 316L	Quick coupling fittings in stainless steel AISI 316L	86
Raccordi a innesto rapido - Accessori	Quick coupling fittings - Accessories	88
Collare fissatubo	Conduit clamp collar	90
Pressacavo	Cable gland	95
Accessori	Accessories	100
Ghiere	Ring nuts	110
Guarnizioni	Gasket	112
Curvatubi	Conduit bender	114
Scatole di infilaggio	Feeder boxes	117

Metal systems

Scatole di derivazione	Junction boxes	122
Scatole di derivazione - Accessori	Junction boxes - Accessories	124
Scatole equipaggiate	Equipped boxes	126
Scatole per tunnel	Boxes for tunnels	129
Scatole per tunnel - Accessori	Boxes for tunnels - Accessories	132

Sistemi plastici

Plastic systems

Tubo flessibile in poliammide	Flexible conduit in polyamide	142
Tubo flessibile in poliuretano	Flexible conduit in polyurethane	159
Calze trecciate	Braided sleeveings	160
Calze trecciate - Accessori	Braided sleeveings - Accessories	163
Raccordi metallici per tubi flessibili in PA	Metal connectors for flexible conduits in PA	164
Raccordi ad innesto rapido in PA	Quick-coupler connectors in PA	166
Raccordi	Fittings	188
Elementi di fissaggio	Fasteners	192
Raccordi pressacavo	Gland fittings	197
Pressacavo	Cable gland	200
Ghiere	Ring nuts	202
Accessori	Accessories	203

Attrezzature

Equipments

Foracanal	Duct piercer	206
Tagliadin	Din cutter	208
Attrezzature	Equipments	210
Sistema di foratura	Drilling system	215
Banco di lavoro	Work bench	224
Accessori	Accessories	225



Introduzione

Introduction

Settori d'impiego	Product Applications	4
Filettature	Threads	6
Riferimenti normativi	Reference standards	8
Temperatura di Esercizio	Operating temperature	16
Resistenza agli agenti chimici	Resistance to chemical agents	18
Grado di protezione IP	IP Protection Degree	20

■ Settori d'impiego

Product Applications

Impieghi dei sistemi di protezione DKC Linea Cosmec

Applications of protective systems DKC Cosmec Line



Reparto produzione
Production department



Profilatrice tubo flessibile
Flexible conduit forming machine



Magazzino automatico
Automated warehouse



Magazzino spedizioni
Logistic warehouse

La realizzazione di un impianto elettrico deve essere curata in modo tale che questo non sia causa d'innescò d'incendio, ne impedisca la propagazione senza lo sviluppo di gas o fumi tossici.

Partendo da questo principio fondamentale a tutela della sicurezza, risulta evidente che nei locali con presenza di pubblico (es. discoteche, teatri, centri commerciali, parcheggi sotterranei, ecc.) sono da preferire materiali metallici poiché non costituiscono pericolo d'innescò e risultano assolutamente passivi di fronte alle sollecitazioni esterne, mentre sono da evitare quei materiali plastici che, anche se autoestinguenti, emanano gas tossici in caso d'incendio. In queste situazioni d'impiego, devono essere utilizzati materiali privi di alogeni e a bassa emissione di fumi opachi e tossici. Anche in presenza di roditori (mulini, archivi, mangimifici, depositi di carta, falegnamerie, depuratori, ecc.) è preferibile l'utilizzo dei sistemi metallici, in quanto i sistemi plastici possono essere aggrediti e non offrono sufficienti garanzie di protezione.

E' inoltre da sfatare la complessità nell'esecuzione di un impianto metallico, poiché con i raccordi ad innesto rapido la facilità di montaggio dei componenti ne ha ridotto drasticamente i tempi, rendendolo competitivo rispetto ai sistemi plastici.

I sistemi di protezione DKC Linea Cosmec sono indicati in tutte le applicazioni industriali e negli ambienti con potenziale rischio di:

- URTI
- INTEMPERIE
- MAGGIOR RISCHIO D'INCENDIO
- SICUREZZA

The realization of an electrical installation must be done in a specific way for it not to cause a fire outbreak and prevent it from spreading without developing toxic gases and fumes.

Given this fundamental safety requirement, it stands to reason that in public spaces (for example, discotheques, theatres, shopping centers and underground parking areas) metallic materials are preferable to plastic and PVC products, as they have no risk of igniting and are immune to external forces, unlike the latter, which in case of fire, give off toxic gases.

In such situations, halogen-free materials with a low emission of opaque and toxic fumes are required.

Metallic materials are recommended in locations with the presence of rodents (mills, archives, feeders, paper stores, carpenteries, purifiers, etc.) as they offer complete wire/cable protection if compared to plastic systems.

In addition, metallic systems are no longer complicated to install because of the new quick-couplers, which greatly reduced installation times, thus making them competitive, especially when compared to plastic systems.

DKC's Cosmec line Metallic systems are suitable in all industrial applications and environments with potential risk of:

- COLLISIONS
- SEVERE WEATHER
- GREATER FIRE HAZARD
- SAFETY

■ Settori d'impiego Product Applications

Referenze References



- Autostrada Messina Palermo, Palermo Catania, Galleria del Frejus, Galleria di Macerata, SA.R.C. (Salerno - Reggio C.)
- IDP Ferscalo di Pero, IDP Osmannoro (per manutenzione Treni Alta Velocità)
- Gallerie TAV Roma Napoli, Tronco Ferrovie Nord Milano, galleria TAV Bologna Firenze, Stazione Bologna
- Metropolitana di Atene, Metropolitana di Napoli, Metropolitana di Torino, Metro 4 Metro 5 Milano
- Aeroporti di Monaco, Bucarest, Bologna, Oporto, Malpensa 2000
- Settore ferroviario: Meneghino, TSR, Circumvesuviana, Vivalto, Vivalto 2
- Highway Messina Palermo, Palermo Catania, Frejus tunnel, Macerata tunnel, SA.R.C. (Salerno - Reggio C.)
- IDP Railyard in Ferscalo di Pero, IDP Railyard in Osmannoro (maintenance of High Speed Trains)
- TAV tunnel Roma Napoli, Nord Railway in Milan, TAV tunnel Bologna Firenze, Bologna Railway Station
- Athens Subway, Naples Subway, Turin Subway, Metro 4 Metro 5 Milan
- Airports of Munchen, Bucarest, Bologna, Oporto, Malpensa 2000
- Railway Industry: Meneghino, TSR, Circumvesuviana, Vivalto, Vivalto 2



- Cementificio di Calusco (Siemens)
- Siti Telecom, Wind, Omnitel, galleria Monte Bianco (protezione fibre ottiche per telecomunicazioni)
- Banca d'Italia Frascati, Monte dei Paschi di Siena
- Basi Nato di Comiso, Capodichino, Sigonella, Aviano, Vicenza, Camp Derby, Lago Patria, Creta
- Nuovo stabilimento Ferrari Maranello, stabilimento Campari Novi Ligure, Iveco Torino,
- Progetto MO.S.E Venezia.
- Cement Mill in Calusco (Siemens)
- Telecom, Wind, Omnitel sites, Monte Bianco tunnel (Fiber optic protection for telecommunications)
- Banca d'Italia Frascati offices, Monte dei Paschi di Siena
- NATO Bases in Comiso, Capodichino, Sigonella, Aviano, Vicenza, Camp Derby, Lago Patria, Creta
- New Ferrari's factory in Maranello, Campari's factory in Novi Ligure, Iveco Turin,
- Project MO.S.E Venice.



- Centrali del progetto "SERENE" (Centrali di cogenerazione all'interno di cinque stabilimenti Fiat.)
- Centrale di cogenerazione gruppo Edison, A.E.M. Milano Bicocca, Sarmato, Terni, Jesi, Torviscosa
- Centrali Elettriche: La Spezia, Brindisi, Fusine, Termini Imerese, Vado Ligure, La Casella Piacenza
- Torvaldaliga Nord, Simeri Crichi, Rizziconi
- Inceneritore e Cogenerazione di Figino MI (ABB), Inceneritori Regione Campania
- Centrali di desalinizzazione a Doha West & Az Zour South in Kuwait
- Plants of "SERENE" project (Co-generation plants in five FIAT plants)
- Co-generation plants - Edison group, A.E.M. Milano Bicocca, Sarmato, Terni, Jesi, Torviscosa
- Power Plants: La Spezia, Brindisi, Fusine, Termini Imerese, Vado Ligure, La Casella Piacenza
- Torvaldaliga Nord, Simeri Crichi, Rizziconi
- Incinerator and Co-generation Plant in Figino (MI) ABB, Incinerators Calabria Region
- Desalination Plant in Doha West & Az Zour South in Kuwait



- Fiera di Milano, Lingotto Torino, Il Portello
- Auditorium di Roma, Teatro La Fenice di Venezia, Teatro Regio di Torino, Teatro di Cortona
- Centri commerciali: Euromercato BO, Ipercoop Collestrada PG, Ikea Fiumara GE
- EXPO Milano 2015
- Fiera Milan, Lingotto Torino, Il Portello
- Rome Auditorium, La Fenice Municipal Theatre in Venice, Municipal Theatre Regio in Turin, Municipal Theatre in Cortona
- Shopping centres: Euromercato BO, Ipercoop Collestrada PG, Ikea Fiumara GE
- EXPO Milan 2015

Filettature Threads

Filettatura Metrica (Norme EN 60423 e UNI 5542-65) Metric Thread (EN 60423 and UNI 5542-65 Standards)

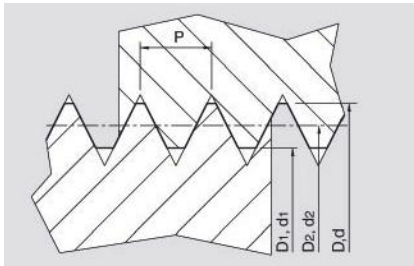

Dimensioni in mm
Dimensions in mm

	FILETTATURE ESTERNE EXTERNAL THREADS				FILETTATURE INTERNE INTERNAL THREADS		
	PASSO PITCH	DIAM. ESTERNO EXT. DIAM.	DIAM. MEDIO AVER. DIAM.	DIAM. NOCCILOLO CORE DIAM.	DIAM. ESTERNO EXT. DIAM.	DIAM. MEDIO AVER. DIAM.	DIAM. INTERNO INT. DIAM.
	P	d	d ₂	d ₁	D	D ₂	D ₁
M12	1,5	11,968	10,994	10,128	12	11,026	10,376
M16	1,5	15,968	14,994	14,128	16	15,026	14,376
M20	1,5	19,968	18,994	18,128	20	19,026	18,376
M25	1,5	24,968	23,994	23,128	25	24,026	23,376
M32	1,5	31,968	30,994	30,128	32	31,026	30,376
M40	1,5	39,968	38,994	38,128	40	39,026	38,376
M50	1,5	49,968	48,994	48,128	50	49,026	48,376
M63	1,5	62,968	61,994	61,128	63	62,026	61,376

Unica tipologia di filetto ammessa dalla norma CEI EN 61386
The only thread type permitted by the CEI EN 61386 standard

Filettatura PG (Norma DIN 40430) PG Thread (DIN 40430 Standard)

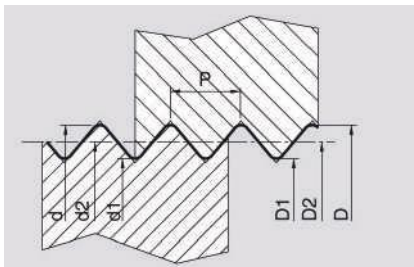

	DIAM. EST. FILETTATURA EXT. DIAM. THREAD	DIAM. MEDIO AVERAGE DIAM.	DIAM. NOCCILOLO CORE DIAM.	PASSO PITCH	N. FILETTI PER 1" N. OF THREADS PER 1"
	d = D	d ₂ = D ₂	d ₁ = D ₁	P	z
PG7	12,50	11,89	11,28	1,27	20
PG 9	15,20	14,53	13,86	1,41	18
PG 11	18,60	17,93	17,26	1,41	18
PG 13,5	20,40	19,73	19,06	1,41	18
PG 16	22,50	21,83	21,16	1,41	18
PG 21	28,30	27,54	26,78	1,588	16
PG 29	37,00	36,24	35,48	1,588	16
PG 36	47,00	46,24	45,48	1,588	16
PG 42	54,00	53,24	52,48	1,588	16
PG 48	59,30	58,54	57,78	1,588	16

Filettatura GAS (Norma UNI ISO 228/1) GAS Thread (UNI ISO 228/1 Standard)

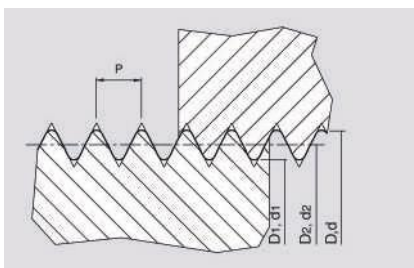

Dimensioni in mm 1" = 25,4 mm
Dimensions in mm 1" = 25,4 mm

	DIAM. EST. FILETTATURA EXT. DIAM. THREAD	DIAM. MEDIO AVERAGE DIAM.	DIAM. NOCCILOLO CORE DIAM.	PASSO PITCH	N. FILETTI PER 1" N. OF THREADS PER 1"
	d = D	d ₂ = D ₂	d ₁ = D ₁	P	z
G 1/4"	13,157	12,301	11,445	1,337	19
G 3/8"	16,662	15,806	14,950	1,337	19
G 1/2"	20,955	19,793	18,631	1,814	14
G 3/4"	26,441	25,279	24,117	1,814	14
G 1"	33,249	31,770	30,291	2,309	11
G1 1/4"	41,910	40,431	38,952	2,309	11
G1 1/2"	47,803	46,324	44,845	2,309	11
G2"	59,614	58,135	56,656	2,309	11
G2 1/2"	75,184	73,705	72,226	2,309	11
G3"	87,884	86,405	84,926	2,309	11
G4"	113,030	111,551	110,072	2,309	11
G5"	138,430	136,951	135,472	2,309	11

Filettature Threads

Filettatura NPT (Norma ANSI/ASA B 2.1) NPT Thread (ANSI/ASA B 2.1 Standard)

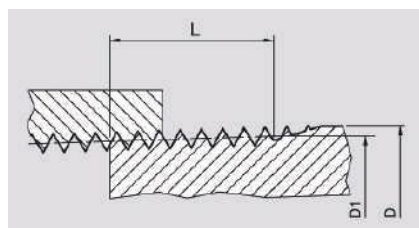

	DIAM. ESTERNO EXT. DIAM.	FILETTATURA ESTERNA UTILIZZABILE USABLE EXTERNAL THREAD		PASSO PITCH	N. FILETTI PER 1" N. OF THREADS PER 1"
	D	L	D ₁	P	z
NPT 1/4"	13,716	10,206	12,7635	1,411	19
NPT 3/8"	17,145	10,358	16,1925	1,411	19
NPT 1/2"	21,336	13,556	20,1115	1,814	14
NPT 3/4"	26,670	13,861	25,4455	1,814	14
NPT 1"	33,401	17,343	31,9100	2,309	11 1/2
NPT 1 1/4"	42,164	17,953	40,6730	2,309	11 1/2
NPT 1 1/2"	48,260	18,377	46,7690	2,309	11 1/2
NPT 2"	60,325	19,215	58,8340	2,309	11 1/2
NPT2 1/2"	73,025	28,892	70,8817	3,175	8
NPT 3"	88,900	30,480	86,7567	3,175	8
NPT 4"	114,300	33,020	112,1567	3,175	8
NPT 5"	141,300	35,720	139,1569	3,175	8

Tabella filettature e diametri di foratura Threads table and perforation diameters

Nella sezione Attrezzature è possibile trovare tutte le fustelle e attrezzature per la foratura

In the Equipment section you can find all the perforations and drilling equipment

Filetto ISO Metrico secondo la norma CEI EN 60423 ISO Metric thread according to CEI EN 60423

FILETTATURA THREAD	Ø FILETTO mm Ø THREAD mm	Ø FORATURA mm Ø PUNCHING mm
M16	16	16,2
M20	20	20,4
M25	25	25,4
M32	32	32,5
M40	40	40,5
M50	50	50,5
M63	63	63,5

Filetto PG secondo la norma DIN 40430 PG thread according to DIN 40430

FILETTATURA THREAD	Ø FILETTO mm Ø THREAD mm	Ø FORATURA mm Ø PUNCHING mm
PG 9	15,2	15,5
PG 11	18,6	19,5
PG 13,5	20,4	21
PG 16	22,5	22,5
PG 21	28,3	28,5
PG 29	37	37
PG 36	47	48
PG 42	54	54
PG 48	59,3	60,5

Filetto GAS Cilindrico secondo la norma UNI ISO 228 Cylindrical GAS thread according to UNI ISO 228

FILETTATURA THREAD	Ø FILETTO mm Ø THREAD mm	Ø FORATURA mm Ø PUNCHING mm
3/8"	16,652	17
1/2"	20,955	21
5/8"	22,911	24
3/4"	26,441	26,5
7/8"	30,201	30,5
1"	33,249	33,5
1" 1/8	37,897	38,5
1" 1/4	41,910	42
1" 1/2	47,803	48
1" 3/4	53,746	54
2"	59,614	60,5
2" 1/2	75,184	75
3"	87,884	91
4"	113,030	115
5"	138,430	140

Riferimenti Normativi Reference Standards

Sistemi di tubi e accessori per installazioni elettriche CEI EN 61386 Conduit systems and accessories for electrical installations IEC EN 61386

Dal giugno 2005 sostituisce la norma CEI EN 50086 e specifica le prescrizioni e le prove applicabili ai sistemi di tubi e accessori, destinati alla protezione e all'installazione dei conduttori isolati e/o dei cavi negli impianti elettrici o nei sistemi di telecomunicazione fino a 1000 V c.a. e/o fino a 1500V c.c.. Si applica ai sistemi di tubi e accessori. Non si applica agli involucri ed alle scatole di connessione che sono oggetto della IEC 60670.

La norma prevede che il sistema venga classificato in base alle proprietà dichiarate, tramite una serie di codici riferiti alle caratteristiche meccaniche, termiche ed elettriche.

Since June 2005 it replaces the EN 50086 standard while specifying requirements and tests for conduit systems and accessories, the protection & management of insulated conductors and/or cables in electrical installations, or in communication systems up to 1000 V c.a. and/or to 1500V c.c.. This standard applies to conduit and accessories systems. This standard does not apply to enclosures and connecting boxes which are subject to the IEC 60670. The rule states that the system is classified on the declared property, through a classification coding format referring to the mechanical, thermal and electrical features.

CODICI DI CLASSIFICAZIONE secondo le norme CEI EN 61386
CLASSIFICATION CODES in compliance with IEC EN 61386 standards

	0	1	2	3	4	5	6	7
1° num. Resistenza alla compressione Compressive strength		molto leggero very light 125 N	leggero light 320 N	medio medium 750 N	pesante heavy 1250 N	molto pesante very heavy 4000 N		
2° num. Resistenza all'urto Resistance to impact		molto leggero very light 0,5 J	leggero light 1 J	medio medium 2 J	pesante heavy 6 J	molto pesante very heavy 20 J		
3° num. Temperatura min. di utilizzo Minimum temperature of use		+5°C	-5°C	-15°C	-25°C	-45°C		
4° num. Temperatura max di utilizzo Max temperature of use		+60°C	+90°C	+105°C	+120°C	+150°C	+250°C	+400°C
5° num. Resistenza alla curvatura Resistance to bending		rigido rigid	pieghevole pliable	autorinvenente self-recovering	flessibile flexible			
6° num. Caratteristiche elettriche Electrical characteristics	N.D.	con continuità with continuity	con isolamento with insulation	continuità ed isolamento continuity and insulation				
7° num. Protezione ai solidi Protection against solids				solidi solids > Ø 2,5 mm	solidi solids > Ø 1 mm	polvere dust	totalmente protetto fully protected	
8° num. Protezione all'acqua Protection against water	N.D.	gocce verticali vertical drops	gocce inclinate inclined drops	pioggia rain	spruzzi splashing	getti jets	getti potenti powerful jets	immersione immersion
9° num. Resistenza alla corrosione Resistance against corrosion		debole int./est. weal ins./out	media int./est. medium ins./out.	media int./ alta est. medium ins./ high out.	alta int./est. high ins./out.			
10° num. Resistenza alla trazione Tensile strength	N.D.	molto leggero very light 100 N	leggero light 250 N	medio medium 500 N	pesante heavy 1000 N	molto pesante very heavy 2500 N		
11° num. Resistenza alla propag. della fiamma Resistance to flame propagation		non propagante non flammable	propagante inflammable					
12° num. Resistenza al carico sospeso Resistance to suspended load	N.D.	molto leggero very light 20 N	leggero light 30 N	medio medium 150 N	pesante heavy 450 N	molto pesante very heavy 850 N		

Riferimenti Normativi Reference Standards

Classificazione CEI EN 61386 dei sistemi DKC Linea Cosmec DKC Cosmec Line systems IEC 61386 Classification

La classificazione si intende per il sistema di protezione tubo-raccordo. I codici sono assegnati come valore minimo valido per tutta la serie di misure, per alcuni articoli pertanto, i valori effettivi potrebbero risultare superiori a quanto indicato in tabella. Per i sistemi plastici, i codici assegnati si riferiscono ai sistemi con Ø nominale DN 21,2 mm.

Classification refers to the conduit-fitting protection system. The codes are assigned as the minimum value valid for the entire series of measurements; therefore, for some items, the actual values could be higher than those given in the table. For plastic systems, the codes assigned refer to system with nominal Ø DN 21,2 mm.

Metallico Metallic

	1° NUM. Res. compressione Resistance to compression	2° NUM. Res. urto Resistance to impact	3° NUM. Temp. minima di utilizzo Minimum temperature of use	4° NUM. Temp. massima di utilizzo Max temp. of use	5° NUM. Res. curvatura Resistance to bending	6° NUM. Caratt. elettriche Electrical characteristics	7° NUM. Protezione ai solidi Protection against solids	8° NUM. Protezione all'acqua Protection against water	9° NUM. Res. corrosione Resistance against corrosion	10° NUM. Res. trazione Tensile strength	11° NUM. Res. propag. fiamma Resistance to flame propagation	12° NUM. Res. carico sospeso Resistance to suspended load
6070	3	4	3	1	2	1	6	6/8	-	3	1	4
607E	3	4	3	1	2	1	6	6/8	-	3	1	4
607ETX	3	4	4	1	2	1	6	6/8	-	3	1	4
6071	3	4	3	1	2	1	6	6/8	-	3	1	4
6071T	3	4	3	1	2	1	6	6/8	-	3	1	4
6071TX	3	4	3	1	2	1	6	6/8	-	3	1	4
6071E	3	4	3	1	2	1	6	6/8	-	3	1	4
6071ET	3	4	4	1	2	1	6	6/8	-	3	1	4
607T	3	3	5	6	4	1	6	0	-	3	1	4
6071ETX	3	4	4	1	2	1	6	6/8	-	3	1	4
667M	3	3	5	6	4	1	4	0	-	3	1	4
667DM	4	4	5	6	4	1	4	0	-	4	1	4
667DXM	4	4	5	6	4	1	4	0	-	4	1	4
607D	4	4	3	1	2	1	6	6/8	-	4	1	4
607DX	4	4	3	1	2	1	6	6/8	-	4	1	4
607DXX	4	4	3	1	2	1	6	6/8	-	4	1	4
607PU	4	4	5	3	2	1	6	6/8	-	4	1	4
6071PU	3	4	5	3	2	1	6	6/8	-	3	1	4
607DBT	4	4	4	4	2	1	6	6/8	-	4	1	4
607X	5	5	5	7	2	1	6	7	-	5	1	5
6085	0	2	3	1	4	2	6	7	-	0	1	0
6089	0	2	3	1	4	2	6	7	-	0	1	0
6080	1	3	1	1	4	2	6	5	-	0	1	0
6079	2	3	1	1	4	2	6	5	-	0	1	0
6008-L	5	5	5	5	1	1	6	6/8	2	4	1	4
6008-P	5	5	5	5	1	1	6	6/8	2	4	1	4
6700	5	5	5	5	1	1	6	6/8	4	4	1	4
6700A	5	5	5	5	1	1	6	6/8	4	4	1	4

Plastico Plastic

	1° NUM. Res. compressione Resistance to compression	2° NUM. Res. urto Resistance to impact	3° NUM. Temp. minima di utilizzo Minimum temperature of use	4° NUM. Temp. massima di utilizzo Max temp. of use	5° NUM. Res. curvatura Resistance to bending	6° NUM. Caratt. elettriche Electrical characteristics	7° NUM. Protezione ai solidi Protection against solids	8° NUM. Protezione all'acqua Protection against water	9° NUM. Res. corrosione Resistance against corrosion	10° NUM. Res. trazione Tensile strength	11° NUM. Res. propag. fiamma Resistance to flame propagation	12° NUM. Res. carico sospeso Resistance to suspended load
5000	2	3	2	4	4	0	6	7	-	1	1	2
5000	2	4	2	2	4	0	6	7	-	1	1	2
5008-TX	2	3	4	3	4	0	6	7	-	1	-	-
50HT	1	4	2	5	4	0	6	7	-	1	1	-
50NF	2	3	2	4	4	0	6	7	-	1	1	2
50NF-TX	2	4	2	4	4	0	6	7	-	1	1	2
5000-T	2	4	2	4	4	0	6	7	-	1	1	2
5002	2	3	4	4	4	0	6	7	-	1	1	2
5008	2	3	4	3	4	0	6	7	-	1	-	-
5008L	1	1	4	4	4	0	6	7	-	1	-	-
5001	2	3	5	4	4	2	6	7	-	2	1	2
5001PN	2	3	5	4	4	2	6	7	-	2	1	2
5001-TX	2	4	5	4	4	2	6	7	-	2	1	2
5001FN	2	3	5	4	4	2	6	7	-	2	1	2
5006	-	-	5	4	4	2	6	7	-	-	1	-

Riferimenti Normativi Reference Standards

Protezione delle strutture di acciaio dalla corrosione Protection of steel structures from corrosion UNI EN ISO 12944-6:2018 (E)

ISO 12944 fu pubblicata per la prima volta nel 1998 come norma standard europea ed internazionale - unico riferimento qualificato a livello mondiale per la protezione dalla corrosione di strutture in acciaio - unificando la moltitudine di norme nazionali standard preesistenti come BS 5493 e DIN 55928. ISO 12944 riguarda la protezione dalla corrosione di supporti di acciaio nudo, acciaio zincato per immersione a caldo e superfici di acciaio zincate mediante spruzzatura a caldo.

La norma è divisa in 8 sezioni che coprono dalla misurazione della corrosività dei vari ambienti, alla preparazione del supporto ed alle procedure dei test di laboratorio.

La norma è stata recentemente aggiornata sostituendo la versione precedente del 1998, è stata introdotta una nuova classe di corrosività, modificate le durabilità e aggiornati i testi per i criteri di valutazione/validazione.

ISO 12944 was published for the first time in 1998 as an international and European standard - becoming the only qualified worldwide reference for the corrosion protection of steel structures -, unifying the multitude of existing national standards, such as BS 5493 and DIN 55928. ISO 12944 relates to the corrosion protection of bare steel supports, hot-dip galvanized steel and steel surfaces galvanized by hot spraying.

The standard is divided into 8 sections, ranging from corrosivity measurement of various environments, to support preparation and laboratory tests procedures. The standard has recently been updated, replacing the previous version of 1998, a new class of corrosivity was introduced, the durability and updates of the texts for the evaluation / validation criteria have been modified.

CLASSE DI CORROSIVITÀ CORROSIONITY CLASS	VELOCITÀ DI CORROSIONE µm PER ANNO CORROSION RATE µm PER YEAR	ESEMPI DI AMBIENTI TIPICI IN UN CLIMA TEMPERATO EXAMPLES OF TYPICAL ENVIRONMENTS IN A TEMPERATE CLIMATE	
		INTERNO INTERNAL	ESTERNO EXTERNAL
C1 Molto bassa Very low	<0,1	Edifici riscaldati con atmosfera pulita (uffici, negozi, scuole, alberghi) Buildings heated with clean atmosphere (offices, shops, schools, hotels)	-
C2 Bassa Low	0,1-0,7	Condensa occasionale. Aree naturali. Ambienti con basso livello di inquinamento. Occasional condensation. Natural areas Environments with low level of pollution.	Rurale. Edifici non riscaldati dove può verificarsi condensa (depositi, locali sportivi) Rural. Unheated buildings where condensate may occur (depots, sports hall)
C3 Media Medium	0,7-2	Umidità elevata, leggero inquinamento dell'aria. Ambienti urbani e industriali, modesto inquinamento da anidride solforosa. Zone costiere con bassa salinità. High humidity, light air pollution. Urban and industrial environments, moderate sulphur dioxide pollution. Coastal areas with low salinity.	Entroterra urbano o costiero mite. Locali di produzione con alta umidità e un certo inquinamento atmosferico (industrie alimentari, lavanderie, birrifici, caseifici) Mild urban or coastal hinterland. Production areas with high humidity and some air pollution (food industries, laundries, breweries, dairies).
C4 Alta High	2-4	Aree industriali e zone costiere con moderata salinità. Industrial areas and coastal zones with moderate salinity.	Entroterra industriale o urbano costiero. Impianti chimici, piscine, cantieri costieri per imbarcazioni. Industrial or urban coastal hinterland. Chemical plants, swimming pools, building sites for boats.
C5 I Molto alta (industriale) Very high (industrial)	4-8	Aree industriali con alta umidità e atmosfera aggressiva. Industrial areas with high humidity and aggressive atmosphere.	Edifici o aree con condensa quasi permanente e con alto inquinamento. Buildings or areas with almost permanent condensation and with high pollution.
C5 M Molto alta (Marina) Very high (Marine)	4-8	Zone costiere e offshore con alta salinità. Coastal and offshore areas with high salinity.	Edifici o aree con condensa quasi permanente e con alto inquinamento. Buildings or areas with almost permanent condensation and with high pollution.

Classe di durabilità

La durabilità è espressa secondo 4 classi (UNI EN ISO 12944-1):

- Bassa (L) = fino a 7 anni
- Media (M) = da 7 a 15 anni
- Alta (H) = da 15 a 25 anni
- Molto Alta (VH) = oltre 25 anni

La durabilità viene indicata a fianco della categoria di corrosività dell'ambiente per consentire la definizione del ciclo di protezione in grado di operare in quell'ambiente e di garantire appunto la durabilità richiesta (es. C4-Alto, C3-Basso, ecc.).

Durability class

Durability is expressed according to 4 classes (UNI EN ISO 12944-1):

- Low (L) = up to 7 Years
- Medium (M) = from 7 to 15 years
- High (H) = from 15 to 25 years
- Very high (VH) = over 25 years

The durability is indicated next to the category of corrosivity of the environment to allow the definition of the protection cycle capable of operating in that environment, and to ensure precisely the durability required (e.g. C4-High, C3-Low, etc.).

■ Riferimenti Normativi Reference Standards

CEI EN 62444

Pressacavi metrici per installazioni elettriche

IEC EN 62444

Metric cable glands for electrical installations

La presente norma fornisce le prescrizioni e le prove relative alla costruzione ed alla prestazione dei pressacavo metrici per cavi elettrici. La norma si riferisce ai pressacavo completi allo stato di consegna da parte del costruttore o fornitore e non ai loro singoli componenti.

Per le applicazioni in "Aree pericolose" è opportuno considerare le prescrizioni supplementari previste per tali condizioni, per es. come specificato nella EN 50014.

This standard provides the requirements and the tests relating to the construction and performance of metric cable glands for electrical cables.

This standard covers complete glands, just as supplied by the manufacturer or supplier, instead of the single gland components. For applications in "Hazardous Areas", it is appropriate to consider the additional requirements laid down for such conditions, e.g. as specified in EN 50014.

CEI EN 60670-1 60670-22

Scatole e involucri per apparecchi elettrici per installazioni elettriche fisse per usi domestici e similari

IEC EN 60670-1 60670-22

Boxes and enclosures for electrical equipment for household and similar fixed electrical installations

La presente parte della CEI EN 60670 si applica alle scatole, agli involucri o a parti di involucri con tensione nominale non superiore a 1000 V in c.a. e a 1500 V in c.c., destinati ad installazioni elettriche fisse per usi domestici e similari, per interni o per esterni. Essa è destinata ad essere applicata alle scatole e agli involucri per apparecchi elettrici compresi nel campo di applicazione del Comitato Tecnico 23. Sostituisce parzialmente la Norma CEI 23-48:1998 che rimane in vigore fino a completa integrazione con le parti seconde della presente norma.

This part of the IEC 60670 applies to boxes, enclosures or parts of enclosures with a rated voltage not exceeding 1000 V AC and 1500 V DC, intended for household or similar fixed electrical installations, either indoors or outdoors.

This International Standard is meant to be applied to boxes and enclosure for electrical accessories included in the fields of applications of the Technical Committee 23. It partially replaces the standard IEC 23-48:1998 which remains in force until the complete integration with the second part of this standard.

CEI EN 60204-1

Sicurezza del macchinario - Equipaggiamento elettrico delle macchine

IEC EN 60204-1

Machine safety - Electrical equipment of the machines.

Fornisce le prescrizioni e le raccomandazioni relative all'equipaggiamento elettrico delle macchine in modo da perseguire la sicurezza delle persone e dei beni, la congruenza delle risposte ai comandi e la facilità della manutenzione.

Si applica alla realizzazione di equipaggiamenti e sistemi elettrici, elettronici ed elettronici programmabili per macchine che lavorano in modo coordinato, con tensioni nominali non superiori a 1000 V c.a. o 1500 V c.c. e con frequenze nominali non superiori a 200 Hz. Essa non copre tutte le prescrizioni (per es. protezioni, interblocchi o comandi) necessarie o richieste da altre norme o regolamenti, al fine di proteggere le persone da pericoli diversi da quelli elettrici.

Provides the requirements and recommendations regarding the electrical equipment of machines to pursue the safety of people and goods, the consistency of the responses to commands and the ease of maintenance.

It applies to the realization of electrical equipment and systems, electronic and programmable electronic for machines that work in a coordinated way, with rated voltages not exceeding 1000 V AC or 1500 V DC and with nominal frequencies not exceeding 200 Hz.

It does not cover all the requirements (e.g. protections, interlocks or commands) necessary or required by other standards or regulations to protect people from hazards different from the electric ones.

CEI EN 60423

Tubi per installazioni elettriche - Diametri esterni dei tubi per installazioni elettriche e filettature per tubi ed accessori

IEC EN 60423

Conduits for electrical installations - External diameters of Conduits for electrical installations and fittings for pipes and accessories

La presente norma internazionale specifica i diametri esterni dei tubi usati nelle installazioni elettriche e le prescrizioni dimensionali delle filettature nei tubi e relativi accessori.

L'unica filettatura ammessa è di tipo metrico ISO 68, pertanto solamente i sistemi rispondenti a questa prescrizione risultano conformi alla norma di prodotto CEI EN 61386.

This International Standard specifies the external diameters of conduits used in electrical installations and the dimensional requirements for threads in the conduits and accessories.

The only admitted thread is metric type ISO 68, therefore only the systems meeting this requirement is in accordance with the IEC 61386 standard.

■ Riferimenti Normativi Reference Standards

Infiammabilità UL94 - Test di infiammabilità delle materie plastiche UL94 Flammability - Flammability test of plastic materials

Gli standard UL 94 sono i riferimenti più diffusi a livello mondiale per la valutazione del comportamento alla fiamma dei materiali plastici. Questi metodi di prova misurano la capacità di autoestinguenza del materiale dopo che questo è stato infiammato. Vengono verificati diversi parametri, come la velocità di combustione, il tempo necessario all'estinzione, la capacità di resistere al gocciolamento e se le gocce bruciano oppure no. I valori di autoestinguenza dichiarati nel presente catalogo, sono risultati di prove svolte da laboratori accreditati sui singoli prodotti finiti (situazione reale d'impiego).

UL 94 standard is the most widely spread worldwide reference regarding the assessment of flammability of plastic materials. These test methods are used to measure self-extinguishing properties of a material after it has been set aflame. Various parameters are verified, such as combustion rate, time necessary for extinguishing, dripping resistance and whether drops burn or not. The self-extinguishing values stated in this catalog are the results of tests carried out by accredited laboratories on the individual finished products (real situation of use).

	V0	V1	V2	HB
Posizione Provino Specimen position	Verticale Vertical	Verticale Vertical	Verticale Vertical	Orizzontale Horizontal
Tempo di Combustione Combustion time	Entro 10 sec Within 10 sec	Entro 30 sec Within 30 sec	Entro 30 sec Within 30 sec	Combustione lenta < 76 mm/min con spessore < 3 mm Slow combustion < 76 mm/min with thickness < 3 mm
Gocciolamento Dripping	No No	No No	Sì Yes	-

Compatibilità elettromagnetica Electromagnetic compatibility

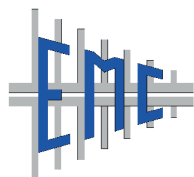

La Compatibilità Elettromagnetica (EMC) valuta i disturbi elettromagnetici generati da tutte le apparecchiature elettriche ed elettroniche (emissioni), nonché, eventuali malfunzionamenti causati da perturbazioni generate da altre sorgenti di disturbo. Essa si applica anche agli impianti e alle installazioni che contengono apparecchiature e componenti elettrici e/o elettronici (anche montati a bordo di macchine). L'uso sempre più spinto di apparati elettrici ed elettronici, infatti, richiede la caratterizzazione dell'ambiente elettromagnetico al fine di eliminare o circoscrivere fenomeni di interferenza, i quali possono dare origine a malfunzionamenti temporanei o permanenti. **Come previsto dalle normative CEI EN 61386, tutti i nostri sistemi di protezione risultano passivi rispetto alle influenze elettromagnetiche (emissioni ed immunità).** Non essendo disponibile una normativa di riferimento specifica per la misura dell'efficienza di schermatura per involucri tubolari si è adottata la metodologia proposta dalla norma IEC TS61587 (Mechanical structures for electronic equipment - Test for IEC 60917 and 60297 Part 3: Electromagnetic shielding performance tests for cabinets, rack and sub-racks).

Electromagnetic Compatibility (EMC) evaluates the electromagnetic noise generated by all electrical and electronic equipment (emissions), as well as any malfunction of the same equipment caused by interferences. This applies to systems and installations containing electrical and/or electronic equipment and components (including those assembled on machinery). The increasingly intensive use of electrical and electronic equipment requires the characterization of the electromagnetic environment to eliminate or isolate interferences which can cause temporary or permanent malfunctioning. **As specified in the IEC EN 61386 standards, in terms of electromagnetic influences, all our protection systems are passive (emissions and immunity).** Since a specific reference standard for the measurement of the efficiency of shielding for conduit sheathing is not available, we adopted the methodology proposed by the standard IEC TS61587 (Mechanical structures for electronic equipment - Tests for IEC 60917 and 60297. Part 3: Electromagnetic shielding performance tests for cabinets, rack, and sub-racks).

RoHS RoHS



Impone restrizioni sull'uso di determinate sostanze pericolose nella costruzione di vari tipi di apparecchiature elettriche; strettamente collegata alla direttiva (RAEE) che regola la raccolta e il riciclo dei prodotti elettrici. La direttiva RoHS limita l'uso di alcune sostanze pericolose.

Tutti gli articoli prodotti o commercializzati da DKC Linea Cosmec sono conformi alla direttiva RoHS.

It imposes a series of restrictions concerning the use of certain hazardous substances in the manufacturing of various types of electrical equipment. It is closely linked to (WEEE) directive, which regulates the collection and recycling of electrical products. The RoHS restricts the use of some dangerous substances.

All the articles manufactured and marketed DKC Cosmec Line are RoHS Directive compliant.

Riferimenti Normativi Reference Standards

CEI EN 62262

Gradi di protezione degli involucri per apparecchiature elettriche contro impatti meccanici esterni (Codice IK)

IEC EN 62262

Degrees of protection provided by enclosures for electrical equipment against external mechanical impact (Code IK)

La presente norma fornisce un sistema per la classificazione dei gradi di protezione degli involucri per apparecchiature elettriche contro impatti meccanici esterni.

This standard provides a system for the classification of the degrees of protection provided by enclosures for electrical equipment against external mechanical impacts.

Grado IK IK Degree	00	01	02	03	04	05	06	07	08	09	10
Equivalenza in Joule dell'urto Impact energy in Joule	0	0,15	0,20	0,35	0,50	0,70	1,0	2,0	5,0	10,0	20,0

CEI EN 60529

Gradi di protezione degli involucri (Codice IP)

IEC EN 60529

Degrees of protection provided by the enclosures (IP code)

La Norma stabilisce un sistema di classificazione dei gradi di protezione degli involucri per materiale elettrico la cui tensione nominale non supera 72,5 kV. Il codice IP identifica i gradi di protezione di un involucro mediante la combinazione di due cifre: la prima cifra indica la protezione contro l'accesso a parti pericolose e la penetrazione di corpi solidi estranei, la seconda cifra contro l'ingresso di acqua.

This standard describes a system for classifying the degrees of protection provided by enclosures of electrical equipment with nominal voltage not exceeding 72.5 kV. The IP code identifies the degrees of protection provided by an enclosure through the combination of two digits: the first digit indicates protection against access to hazardous parts and the penetration of solid foreign bodies, the second digit against the ingress of water.

PRIMA CIFRA CARATTERISTICA (penetrazione corpi solidi) FIRST CHARACTERISTIC DIGIT (penetration of solid bodies)

0	Nessuna protezione Non-protected
1	Protezione contro i corpi solidi superiori a 50 mm (Protetto contro contatti accidentali) Protection against solid bodies exceeding 50 mm (Protected against accidental contacts)
2	Protezione contro i corpi solidi superiori a 12,5 mm (Protetto contro contatti delle dita) Protection against solid bodies over 12.5 mm (Protected against contact with the fingers)
3	Protezione contro i corpi solidi superiori a 2,5 mm (Protetto contro contatti con utensili) Protection against solid bodies exceeding 2.5 mm (Protected against contact with tools)
4	Protezione contro i corpi solidi superiori a 1 mm. (Protetto contro contatti con un filo) Protection against solid bodies exceeding 1 mm. (Protected against contact with a wire)
5	Protezione contro la polvere, nessun deposito nocivo Protection against dust, no harmful deposit
6	Totalmente protetto contro la polvere Totally protected against dust

SECONDA CIFRA CARATTERISTICA (ingresso di acqua) SECOND CHARACTERISTIC DIGIT (ingress of water)

0	Nessuna protezione Non-protected
1	Protezione contro la caduta verticale di gocce d'acqua. Protection against vertically falling drops of water.
2	Protezione contro la caduta verticale di gocce d'acqua con inclinazione dell'involucro fino a 15 Protection against vertically falling drops of water with inclination of the enclosure up to 15
3	Protezione contro l'acqua con angolo di caduta inferiore o uguale a 60 Protection against water with drop angle lower than or equal to 60
4	Protezione contro gli spruzzi da tutte le direzioni Protection against splashes from all directions
5	Protezione contro i getti d'acqua Protection against water jets
6	Protezione contro le ondate ed i getti d'acqua potenti Protection against waves and the powerful water jets
7	Protezione contro gli effetti di una immersione temporanea Protection against the effects of temporary immersion
8	Protezione contro gli effetti di una immersione continuata Protection against the effects of continuous immersion
9	Protezione contro i getti d'acqua ad alta pressione e a temperatura elevata Protection against high pressure and high temperature water jets

■ Riferimenti Normativi Reference Standards

Certificazione UL 1696 (first edition) CSA C22.2 No. 227.3-05 Certification UL 1696 (first edition) CSA C22.2 No. 227.3-05

Underwriters Laboratories (UL) e la Canadian Standards Association (CSA) hanno collaborato per creare uno standard unificato per disciplinare i requisiti per tubi di protezione non metallici e relativi accessori.
Questa marcatura è utilizzata per prodotti diretti al mercato canadese e statunitense.

Underwriters Laboratories (UL) and Canadian Standards Association (CSA) have collaborated to create a unified standard to regulate the requirements for non-metallic protection conduits and relevant accessories.
This marking is used for products going into the Canadian and US market.



Certificato n.1902213 May 29,2013 rilasciato a Flexa Gmbh & Co KG
Certificate n.1902213 May 29,2013 issued to Flexa Gmbh & Co KG
DN 21,2 ÷54,5



Certificati n.YDRQ2.E86359 e YDRQ8.E86359 rilasciati a Flexa Gmbh & Co KG
Certificates n.YDRQ2.E86359 and YDRQ8.E86359 issued Flexa Gmbh & Co KG
DN 13 ÷54,5

La certificazione IRIS (Railway Industry Standard) ISO/TS 22163:2017 The IRIS certification (Railway Industry Standard) ISO/TS 22163:2017



IRIS è uno standard privato sviluppato da UNIFE (Union of the European Railway Industries) e promosso da quattro dei più importanti produttori di sistemi ferroviari: Bombardier, Siemens, Alstom e Ansaldo-Breda.
Basato sullo standard ISO 9001, riconosciuto in tutto il mondo, la certificazione IRIS è specificamente destinata per la valutazione dei sistemi di gestione di aziende che operano nel settore ferroviario, con lo scopo di massimizzare la qualità e l'affidabilità del materiale rotante attraverso l'evoluzione dell'intera catena di fornitura. La certificazione IRIS è una prova attendibile che i prodotti di un'azienda soddisfano i più severi standard di eccellenza dell'industria ferroviaria. Il certificato ha validità triennale, subordinata a delle verifiche di sorveglianza.

IRIS is a private standard developed by UNIFE (Union of the European Railway Industries) and sponsored by four of the leading manufacturers of railway systems: Bombardier, Siemens, Alstom, and AnsaldoBreda.
Based on ISO 9001, recognized throughout the world, IRIS certification is specifically intended for the evaluation of management systems of companies operating in the railway sector, with the aim of maximizing the quality and reliability of the rolling-stock through the evolution of the whole supply chain.
IRIS certification is a piece of reliable evidence that the company's products meet the highest standards of excellence for the railway industry.
The certificate is valid for three years, subject to the surveillance audits.

Certificato n. 700411005/3 rilasciato a Flexa Gmbh & Co KG

Certificate n. 700411005/3 issued to Flexa Gmbh & Co KG

Riferimenti Normativi

Reference Standards

EN 45545:2013



L'obiettivo di questa norma è quello di ridurre al minimo il rischio d'innescò d'incendio e la sua propagazione a bordo dei veicoli ferroviari, unificandone i requisiti a livello europeo.

La norma suddivide i veicoli ferroviari in 4 categorie operative in base alla facilità di evacuazione:

Categoria 1 NON progettati per gallerie o strutture in elevazione.

Categoria 2 Progettati per gallerie o strutture in elevazione con stazioni di emergenza raggiungibili in tempo breve.

Categoria 3 Progettati per gallerie o strutture in elevazione con stazioni di emergenza raggiungibili in tempi lunghi.

Categoria 4 Progettati per gallerie o strutture in elevazione dove non c'è possibilità di evacuazione.

Oltre alle categorie operative i veicoli vengono suddivisi in 4 categorie di tipo:

N Standard

A Automatico

D Doppio piano

S Vagoni letto

Correlando questi parametri vengono definiti tre livelli di rischio da HL1 a HL3 come raffigurato nella seguente tabella:

The purpose of this standard is to reduce to the minimum the risk of fire ignition and its propagation on board of railway vehicles, unifying the requirements at European level.

The standard divides rail vehicles in 4 operating categories according to the ease of evacuation:

Category 1 NOT designed for tunnels or elevated structures.

Category 2 Designed for tunnels or elevated structures with emergency stations reachable in short time.

Category 3 Designed for tunnels or elevated structures with emergency stations reachable in long time.

Category 4 Designed for tunnels or elevated structures with no possibility of evacuation.

In addition to operational categories, vehicles are divided into 4 categories:

N Standard

A Automatic

D Double deck

S Sleeping cars

By correlating these parameters, three levels of risk are defined, ranging from HL1 to HL3, as shown in the following table:

Funzionamento e categoria di progettazione
Operation and Design category

	N	A	D	S
1	HL1	HL1	HL1	HL2
2	HL2	HL2	HL2	HL2
3	HL2	HL2	HL2	HL3
4	HL3	HL3	HL3	HL3

La parte 2 della norma definisce un sistema di classificazione che specifica i requisiti per il comportamento al fuoco dei materiali e prodotti utilizzati nei treni. Tutto il materiale a bordo è classificato in gruppi che devono soddisfare specifici "Requisiti" che comprendono spesso diversi metodi di prova. Per ogni prova sono definiti i limiti di accettabilità che possono variare a seconda della classe di rischio.

I prodotti DKC Linea Cosmec rientrano nei requisiti R22 e R23 per i quali sono richieste le seguenti prove:

- Indice di ossigeno (LOI) secondo EN ISO4589-2
- Densità ottica dei fumi (Ds max) secondo EN ISO 5659-2 a 25 kW/m²
- Tossicità dei fumi (CIT) secondo NF X 70-100-1/2

I dettagli sono riportati sulle pagine specifiche di prodotto.

Part 2 of the standard defines a classification system that specifies the requirements for the fire behaviour of materials and products used in trains.

All material on board is classified into groups that must meet specific "requirements" which often include different testing methods. For each test are defined the acceptability limits that may vary depending on the class of risk.

DKC's Cosmec line products fall under the R22 and R23 requirements, which require the following tests:

- Oxygen Index (LOI) in compliance with EN ISO4589-2
- Optical density of smoke (Ds max) in compliance with EN ISO 5659-2 at 25 kW/m²
- Smoke toxicity (CIT) in compliance with NF X 70-100-1/2

Details are reported on specific product pages.

■ Temperatura di Esercizio Operating Temperature

Sistemi Metallici Metal Systems

	°C																					
	-60	-50	-45	-40	-25	-15	-5	0	+5	+45	+60	+70	+90	+100	+105	+110	+120	+130	+140	+150	+250	+350
6071					●	●	●	●	●	●	●											
6071E					●	●	●	●	●	●	●											
6071PU	●	●	●	●	●	●	●	●	●	●	●	●	●	●	●	●						
6070					●	●	●	●	●	●	●											
607E					●	●	●	●	●	●	●											
607D					●	●	●	●	●	●	●	●										
607DX					●	●	●	●	●	●	●	●										
607DXX					●	●	●	●	●	●	●	●										
607PU	●	●	●	●	●	●	●	●	●	●	●	●	●	●	●	●	●	●	●	●	●	●
607DBT				●	●	●	●	●	●	●	●	●	●	●	●	●	●	●	●	●	●	●
6071T					●	●	●	●	●	●	●											
6071TX					●	●	●	●	●	●	●											
6071ET					●	●	●	●	●	●	●	●										
6071ETX					●	●	●	●	●	●	●	●										
607ETX					●	●	●	●	●	●	●	●										
667M			●	●	●	●	●	●	●	●	●	●	●	●	●	●	●	●	●	●	●	●
667DM			●	●	●	●	●	●	●	●	●	●	●	●	●	●	●	●	●	●	●	●
667DXM			●	●	●	●	●	●	●	●	●	●	●	●	●	●	●	●	●	●	●	●
667DXXM			●	●	●	●	●	●	●	●	●	●	●	●	●	●	●	●	●	●	●	●
607T			●	●	●	●	●	●	●	●	●	●	●	●	●	●	●	●	●	●	●	●
607X			●	●	●	●	●	●	●	●	●	●	●	●	●	●	●	●	●	●	●	●
607XX			●	●	●	●	●	●	●	●	●	●	●	●	●	●	●	●	●	●	●	●
60HT	●	●	●	●	●	●	●	●	●	●	●	●	●	●	●	●	●	●	●	●	●	●
6085					●	●	●	●	●	●	●	●										
6089					●	●	●	●	●	●	●	●										
6080									●	●	●	●										
6079							●	●	●	●	●	●										
6008L	●	●	●	●	●	●	●	●	●	●	●	●	●	●	●	●	●	●	●	●	●	●
6008P	●	●	●	●	●	●	●	●	●	●	●	●	●	●	●	●	●	●	●	●	●	●
6700	●	●	●	●	●	●	●	●	●	●	●	●	●	●	●	●	●	●	●	●	●	●
6700A	●	●	●	●	●	●	●	●	●	●	●	●	●	●	●	●	●	●	●	●	●	●

■ Temperatura di Esercizio Operating Temperature

Sistemi Plastici Plastic Systems

	°C														
	-60	-50	-45	-40	-25	-15	0	+45	+60	+75	+100	+105	+115	+120	+150
5000 PA 6				●	●	●	●	●	●	●	●	●	●	●	
5000 PA 6-D				●	●	●	●	●	●	●	●	●	●	●	
5008TX					●	●	●	●	●	●	●	●	●	●	
50HT				●	●	●	●	●	●	●	●	●	●	●	●
50NF				●	●	●	●	●	●	●	●	●	●	●	
50NF-TX				●	●	●	●	●	●	●	●	●	●	●	
5000-T				●	●	●	●	●	●	●	●	●	●	●	
5002				●	●	●	●	●	●	●	●	●	●	●	
5008					●	●	●	●	●	●	●	●	●	●	
5008L					●	●	●	●	●	●	●	●	●	●	
5001		●	●	●	●	●	●	●	●	●	●				
5001PN		●	●	●	●	●	●	●	●	●	●				
5001-TX		●	●	●	●	●	●	●	●	●	●				
5001-TX		●	●	●	●	●	●	●	●	●	●				
5004 MULTI				●	●	●	●	●	●	●	●	●	●	●	
5001 MULTI		●	●	●	●	●	●	●	●	●	●				
50ZIP		●	●	●	●	●	●	●	●	●	●				
50DUO				●	●	●	●	●	●	●	●	●	●	●	
5006				●	●	●	●	●	●	●	●	●	●	●	
RACCORDI PA PA FITTING				●	●	●	●	●	●	●	●	●	●	●	

■ Resistenza agli agenti chimici

Resistance to chemical agents

AGENTI CHIMICI CHEMICAL AGENTS	667M 667DM 607T	6070 6071 607D	607E 6071E	607ETX 6071ETX	6071ET	6071T	607PU	6079 6080	6085	6089	6008L 6008P	6700 607X 667DXM 667DXFTX	Raccordo Ottone Nichelato Plated Brass Fitting	5000-T	50NF-TX 5001-TX
Acetato di Vinile Vinyl Acetate	■	■				■	■	■	■	■	■	■	■		
Acetone Acetone	■	■	■	■	■	■	■	■	■	■	■	■	■	■	■
Acido Acetico Acetic Acid	■	■	■	■	■	■	■	■	■	■	■	■	■	■	■
Acido citrico Citric Acid	■	■	■	■	■	■		■	■	■	■	■	■	■	■
Acido cloridrico 10% Hydrochloric acid 10%	■	■	■	■	■	■	■	■	■	■	■	■	■	■	■
Acido cloridrico 36% Hydrochloric acid 36%	■	■	■	■	■	■	■	■	■	■	■	■	■	■	■
Acido Lattico Lactic Acid	■	■	■	■	■	■	■	■	■	■	■	■	■	■	■
Acido Nitrico 10% Nitric Acid 10%	■	■	■	■	■	■	■	■	■	■	■	■	■	■	■
Acido Nitrico 70% Nitric Acid 70%	■	■				■	■	■	■	■	■	■	■	■	■
Acido Ossalico Oxalic Acid	■	■				■	■	■	■	■	■	■	■	■	■
Acido Solforico 10% Sulphuric Acid 10%	■	■	■	■	■	■	■	■	■	■	■	■	■	■	■
Acido Solforico 70% Sulphuric Acid 70%	■	■	■	■	■	■	■	■	■	■	■	■	■	■	■
Acqua di cloro Chloride Water	■	■				■	■	■	■	■	■	■	■	■	■
Acqua di Mare Sea Water	■	■	■	■	■	■	■	■	■	■	■	■	■	■	■
Acqua ossigenata 35% Hydrogen peroxide 35%	■	■	■	■	■	■	■	■	■	■	■	■	■	■	■
Acquaragia Turpentine	■	■				■	■	■	■	■	■	■	■	■	■
Alcool Etilico Ethyl alcohol	■	■				■	■	■	■	■	■	■	■	■	■
Alcool Metilico Methyl alcohol	■	■				■	■	■	■	■	■	■	■	■	■
Benzene Benzene	■	■	■	■	■	■	■	■	■	■	■	■	■	■	■
Benzina Petrol	■	■	■	■	■	■	■	■	■	■	■	■	■	■	■
Cloruro di Alluminio Aluminium Chloride	■	■	■	■	■	■	■	■	■	■	■	■	■	■	■
Cloruro di Sodio Sodium Chloride	■	■				■	■	■	■	■	■	■	■	■	■
Cloruro di Zinco Zinc Chloride	■	■	■	■	■	■	■	■	■	■	■	■	■	■	■
Freon 32 Freon 32	■	■				■	■	■	■	■	■	■	■	■	■
Gas di Ozono Ozone gas	■	■				■	■	■	■	■	■	■	■	■	■
Glicole Etilenico Ethylene Glycol	■	■				■	■	■	■	■	■	■	■	■	■
Idrossido di Sodio 10% Sodium hydroxide 10%	■	■				■	■	■	■	■	■	■	■	■	■
Idrossido di Sodio 60% Sodium hydroxide 60%	■	■				■	■	■	■	■	■	■	■	■	■
Metilbenzene Toluene	■	■	■	■	■	■	■	■	■	■	■	■	■	■	■
Metilchetone Methylketone	■	■				■	■	■	■	■	■	■	■	■	■
Nitrato di Argento Silver nitrate	■	■				■	■	■	■	■	■	■	■	■	■
Olii Vegetali Vegetable oils	■	■				■	■	■	■	■	■	■	■	■	■
Olio ASTM N°1 ASTM oil N°1	■	■	■	■	■	■	■	■	■	■	■	■	■	■	■
Olio ASTM N°2 ASTM oil N°2	■	■	■	■	■	■	■	■	■	■	■	■	■	■	■
Olio ASTM N°3 ASTM oil N°3	■	■	■	■	■	■	■	■	■	■	■	■	■	■	■
Olio di Paraffina Paraffin oil	■	■				■	■	■	■	■	■	■	■	■	■
Olio Diesel Diesel oil	■	■				■	■	■	■	■	■	■	■	■	■
Olio Lubrificante Lubricating oil	■	■	■	■	■	■	■	■	■	■	■	■	■	■	■
Olio per Trasformatori Transformer oil	■	■	■	■	■	■	■	■	■	■	■	■	■	■	■
Spirito Bianco White spirit	■	■				■	■	■	■	■	■	■	■	■	■
Tricloroetilene Trichloroethylene	■	■	■	■	■	■	■	■	■	■	■	■	■	■	■

■ Resistenza agli agenti chimici

Resistance to chemical agents

AGENTI CHIMICI CHEMICAL AGENTS	PA6 5000 50HT 50NF 5002 5008 5008L 5004 50ZIP/50DUO	PA6 treccia acciaio zincato galvanized steel braid 5000-T	PA6 treccia acciaio inox stainless steel braid 50NF-TX 5008-TX	PA12 5001 5001PN 5001FN	PA12 treccia acciaio inox stainless steel braid 5001-TX	PU 5006	PA 6.6 Raccordi Fittings	TPE Raccordi Fittings
Acetone Acetone	■	■	■	■	■	■	■	■
Acido Acetico Acetic Acid	■	■	■	■	■	■	■	■
Acido citrico Citric Acid	■	■	■	■	■	■	■	■
Acido cloridrico 10% Hydrochloric acid 10%	■	■	■	■	■	■	■	■
Acido cloridrico 36% Hydrochloric acid 36%	■	■	■	■	■	■	■	■
Acido Lattico Lactic Acid	■	■	■	■	■	■	■	■
Acido Nitrico 10% Nitric Acid 10%	■	■	■	■	■	■	■	■
Acido Nitrico 70% Nitric Acid 70%	■	■	■	■	■	■	■	■
Acido Ossalico Oxalic Acid	■	■	■	■	■	■	■	■
Acido Solforico 10% Sulfuric Acid 10%	■	■	■	■	■	■	■	■
Acido Solforico 70% Sulfuric Acid 70%	■	■	■	■	■	■	■	■
Acqua di cloro Chloride Water	■	■	■	■	■	■	■	■
Acqua di Mare Sea Water	■	■	■	■	■	■	■	■
Acqua ossigenata 35% Hydrogen peroxide 35%	■	■	■	■	■	■	■	■
Acquaragia Turpentine	■	■	■	■	■	■	■	■
Alcool Etilico Ethyl alcohol	■	■	■	■	■	■	■	■
Alcool Metilico Methyl alcohol	■	■	■	■	■	■	■	■
Benzene Benzene	■	■	■	■	■	■	■	■
Benzina Petrol	■	■	■	■	■	■	■	■
Cloruro di Alluminio Aluminium Chloride	■	■	■	■	■	■	■	■
Cloruro di Sodio Sodium Chloride	■	■	■	■	■	■	■	■
Cloruro di Zinco Zinc Chloride	■	■	■	■	■	■	■	■
Freon 32 Freon 32	■	■	■	■	■	■	■	■
Gas di Ozono Ozone gas	■	■	■	■	■	■	■	■
Glicole Etilenico Ethylene Glycol	■	■	■	■	■	■	■	■
Idrossido di Sodio 10% Sodium hydroxide 10%	■	■	■	■	■	■	■	■
Idrossido di Sodio 60% Sodium hydroxide 60%	■	■	■	■	■	■	■	■
Metilbenzene Toluene	■	■	■	■	■	■	■	■
Metilchetone Methylketone	■	■	■	■	■	■	■	■
Nitrato di Argento Silver nitrate	■	■	■	■	■	■	■	■
Olii Vegetali Vegetable oils	■	■	■	■	■	■	■	■
Olio ASTM N°1 ASTM oil N°1	■	■	■	■	■	■	■	■
Olio ASTM N°2 ASTM oil N°2	■	■	■	■	■	■	■	■
Olio ASTM N°3 ASTM oil N°3	■	■	■	■	■	■	■	■
Olio di Paraffina Paraffin oil	■	■	■	■	■	■	■	■
Olio Diesel Diesel oil	■	■	■	■	■	■	■	■
Olio Lubrificante Lubricating oil	■	■	■	■	■	■	■	■
Olio per Trasformatori Transformer oil	■	■	■	■	■	■	■	■
Spirito Bianco White spirit	■	■	■	■	■	■	■	■
Tricloroetilene Trichloroethylene	■	■	■	■	■	■	■	■



Le informazioni in tabella sono generali e variano in relazione a temperature di esercizio, concentrazione %, ecc.
Per ulteriori informazioni contattare il nostro ufficio tecnico.
The general information in the table may vary in relation to operating temperature, concentration, %, etc.
For further information contact our technical office.

■ Grado di Protezione IP

IP Protection Degree

Secondo le norme CEI EN 60529
According to the standards IEC EN 60529

SISTEMI METALLICI METAL SYSTEMS							SISTEMI PLASTICI PLASTIC SYSTEMS						AUTOESTINGUENZA UL 94 UL 94 SELF-EXTINGUISHING		
IP40	IP44	IP65	IP66	IP67	IP68	IP69	IP54	IP65	IP66	IP67	IP68	IP69K	HB	V2	V0
667M	■						5000 (PA 6)		■		■	■	5000 (PA 6)		■
6070			■		■	■	5000 (PA 6-D)		■		■	■	5000 (PA 6-D)		■
607E			■		■	■	5008-TX		■		■	■	5008-TX	■	
607ETX			■		■	■	50HT		■		■	■	50HT		■
6071	■		■		■	■	50NF		■		■	■	50NF		■
6071T	■		■		■	■	50NF-TX		■		■	■	50NF-TX		■
6071E	■		■		■	■	5000-T		■		■	■	5000-T		■
6071ET	■		■		■	■	5002		■		■	■	5002	■	
6071ETX	■		■		■	■	5008		■		■	■	5008	■	
667M	■						5008L		■		■	■	5008L	■	
667DM	■						5001		■		■	■	5001		■
667DX	■						5001PN		■		■	■	5001PN		■
607D			■		■	■	5001FN		■		■	■	5001FN		■
607PU			■		■	■	5001-TX		■		■	■	5001-TX		■
607DBT			■		■	■	5004 MULTI	■	■		■	■	5004 MULTI	■	
607X					■		5001 MULTI	■	■		■	■	5001 MULTI	■	
6085			■		■		50ZIP						50ZIP	■	
6089					■		50DUO						50DUO	■	
6080			■		■		5006		■		■	■	5006	■	
6079			■				PA RACCORDI FITTING						PA RACCORDI FITTING		■
6008L			■		■	■									
6008P			■		■	■									
6700			■		■	■									
6700A			■		■	■									
607T	■														
6071TX			■		■	■									
667DXXM	■														



Sistemi metallici

Metal systems

Guaina metallica	Flexible / Pliable conduit	26
Tubo pieghevole	Pliable conduit	46
Calza	Sleeve	48
Guaina PVC	PVC flexible conduit	49
Raccordi per tubi metallici flessibili	Fittings for flexible metal conduits	54
Raccordi plastici	Plastic fittings	70
Raccordi metallici - Accessori	Metal fittings - Accessories	74
Tubo rigido	Rigid conduit	76
Raccordi a innesto rapido	Quick coupling fittings	80
Raccordi a innesto rapido - Accessori	Quick coupling fittings - Accessories	88
Collare fissatubo	Conduit clamp collar	90
Pressacavo	Cable gland	95
Accessori	Accessories	100
Curvatubi	Conduit bender	114
Scatole	Boxes	117

■ Sistemi metallici Metal systems

Caratteristiche Characteristics

Assortimento

Ampia gamma dimensionale di tubi rigidi e pieghevoli, realizzati in acciaio zincato o INOX. Diverse tipologie di rivestimento con i relativi accessori, permettono di realizzare sistemi di protezione di qualsiasi complessità.

Facilità di installazione

- I raccordi ad innesto rapido brevettati garantiscono un montaggio facile e veloce senza elementi aggiuntivi.
- Scatole di derivazione a perforazione d'isolante
- Guarnizioni in poliuretano espanso già alloggiato nei coperchi delle scatole.

Affidabilità

- Prodotti certificati.
- Tubi privi di bave o asperità taglienti evitano il danneggiamento dei cavi o il ferimento accidentale.
- Versione in acciaio inossidabile AISI 316 con elevata resistenza alla corrosione per le applicazioni nel settore alimentare e chimico oltre che negli ambienti aggressivi.
- Serie di cassette di derivazione in alluminio, verniciate in forno con polvere poliestere garantiscono un'elevata resistenza alla corrosione.
- Gamma raccordi a doppio bloccaggio per tubi rivestiti con treccia metallica offrono una soluzione tecnica senza eguali.
- Tubi metallici pieghevoli con tre tipologie profilo per assicurare al meglio le esigenze di flessibilità e caratteristiche meccaniche.

Facilità di progettazione

- Un sistema completo di tubi rigidi e pieghevoli, scatole, raccordi ed accessori permettono di trovare soluzioni per qualsiasi progetto.
- Tubi in acciaio zincato e inossidabile
- Guaine con vari tipi di rivestimento permettono di soddisfare ogni esigenza installativa

Range

A wide dimensional range of rigid and flexible conduits made of galvanized steel or stainless steel, with various types of coating complete with accessories allow the creation of protective systems of any complexity.

Ease of installation

- The patented quick connection fittings guarantee installation with no additional accessories.
- Junction boxes with perforated insulation
- Polyurethane foam seals are pre-installed in the covers of the boxes.

Reliability

- Certified products.
- Burr and roughness free conduits prevent damage to the cables or accidental injuries.
- Stainless steel AISI 316 version with high corrosion resistance for applications in food and chemical industries as well as in harsh environments.
- Range of aluminium junction boxes, oven painted with epoxy powders, which provide high corrosion resistance.
- Range of double-lock fittings for metal braided conduits provide excellent technical solutions.
- Metal flexible conduits available in three different types of section to better satisfy flexibility requirements and mechanical features.

Ease of design

- A complete system of rigid and flexible conduits, boxes, connectors and accessories allow the creation of solutions fit to any project.
- Conduits in galvanized and stainless steel
- Flexible conduits with various types of coatings in order to satisfy every operating condition

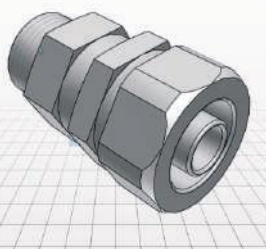

CAD SERVICE

Il CAD service di DKC Linea Cosmec offre un facile accesso al download dei modelli CAD da inserire direttamente nei progetti d'impianto.

I modelli sono disponibili nei formati 2D e 3D utilizzando la biblioteca CAD dei componenti CADENAS, basato sulla tecnologia partcommunity.

Il download è gratuito previa registrazione al portale.

Accesso alle librerie tramite il sito www.dkceurope.com.

The CAD service of DKC's Cosmec Line provides easy access to download CAD models to be directly inserted in the installation projects.

The models are available in 2D and 3D formats using the CAD library of the CADENAS components, based on partcommunity technology.

The download is free after registration to the portal.

Access to libraries through the site www.dkceurope.com.

■ Campi di applicazione Fields of application

I sistemi metallici DKC Linea Cosmec sono stati progettati per garantire la protezione dei cavi negli impianti industriali, strutture del settore terziario, autostrade e ferroviario. A tutela della sicurezza, queste soluzioni d'impianto non costituiscono cuasa d'incendio ne rappresentano una via per la sua propagazione e non sviluppano gas o fumi tossici.

L'elevato grado di protezione da polvere ed acqua, la resistenza alle sollecitazioni meccaniche, ai raggi UV, agli effetti dannosi di oli e solventi e le proprietà di schermatura elettromagnetica, sono solo alcuni dei vantaggi dati dai sistemi proposti.

DKC Cosmec Line metal conduits have been designed to ensure protection for cables in industrial plants, structures of the tertiary sector, highways and railways.

For the purposes of safety, these installation solutions are not hazardous as regards to fire, do not represent a flame propagation path and do not emit toxic gases or fumes.

The high protection degree against water and dust, the good resistance to mechanical stresses, to UV rays, to damaging effects of oils and solvents and the good electromagnetic screening properties, are just some of the advantages of the systems proposed.



Complessi produttivi
Production complexes



Locali a rischio d'incendio
Premises with risk of fire



Locali con presenza di roditori
Premises with the presence of rodents



Infrastrutture dei trasporti
Transport infrastructures



Luoghi di aggregazione di massa
Meeting points



Impianti industriali
Industrial plants



Locali soggetti ad atti vandalici
Premises subject to vandalism



Impianti energetici
Energy plants



Settore alimentare
Food industry

■ Caratteristiche tubi Conduits characteristics

Tubo Metallico flessibile Flexible Metal Conduit

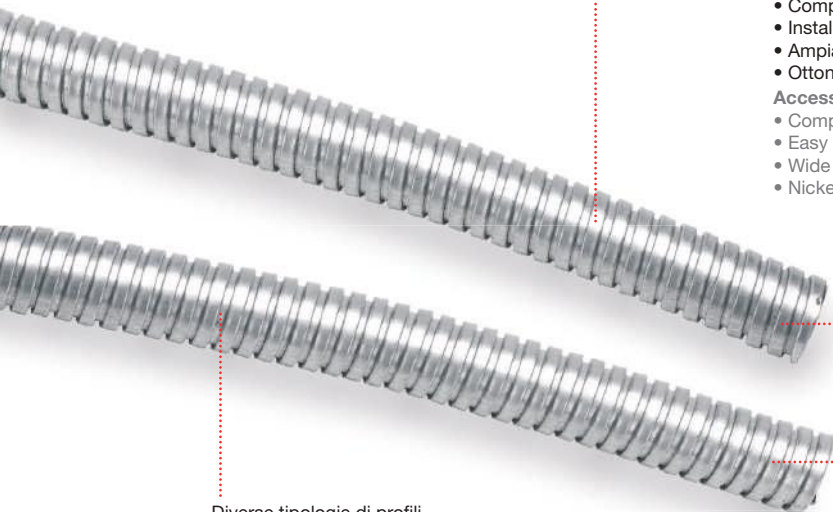

Diverse tipologie di profili
Different profile types

Accessori

- Compatibilità dei tubi con tutti gli accessori
- Installazione facile e affidabile;
- Ampia gamma
- Ottone nichelato o acciaio inox

Accessories

- Compatibility of the conduits with all the accessories
- Easy and reliable installation;
- Wide range
- Nickel plated brass or stainless steel

Vantaggi

- Resistenza alla trazione;
- Resistenza alla compressione;
- Alta flessibilità

Advantages

- Tensile strength;
- Compression strength;
- High flexibility

- Conformi alla norme 61386-1 e 61386-23;
- Prodotti in acciaio zincato Sendzimir
- Prodotti in acciaio inox AISI 304 - AISI 316L
- Complying to 61386-1 and 61386-23 standards;
- Produced in Sendzimir galvanized steel
- Produced in stainless steel AISI 304 - AISI 316L

Rivestimento del tubo metallico Metal conduit coating

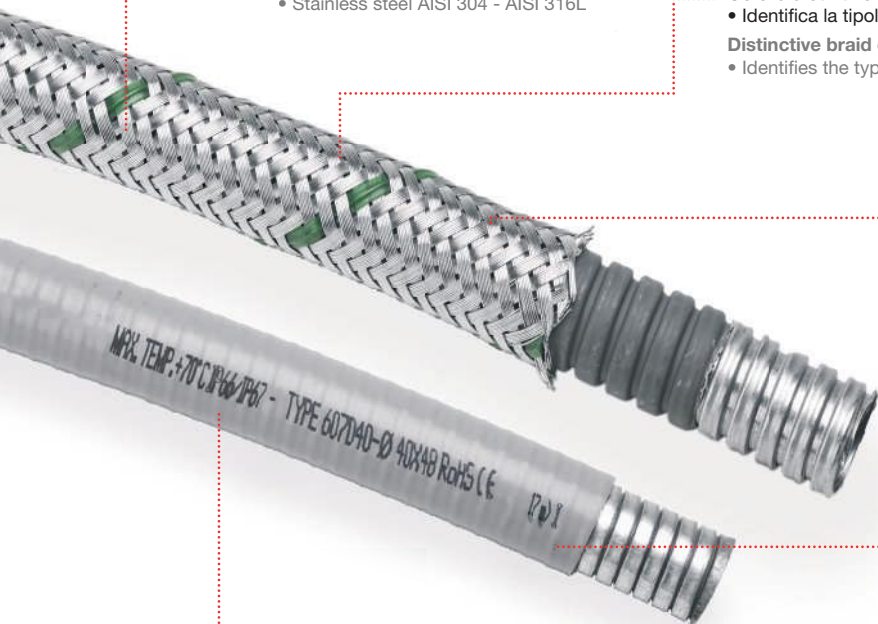

Materiale treccia metallica

- in acciaio zincato Sendzimir
- in acciaio inox AISI 304 - AISI 316L

Material metal braid

- Sendzimir galvanized steel
- Stainless steel AISI 304 - AISI 316L

Colore distintivo treccia

- Identifica la tipologia del rivestimento

Distinctive braid colour

- Identifies the type of the coating

Protezione treccia

- Da sfregamenti e scintillio
- Dalle interferenze elettromagnetiche

Braid protection

- From rubbing and sparking
- From electromagnetic interference

Rivestimento

- Diverso per applicazioni specifiche
- Ancorato sulle spire
- Liscio o aspirato di diversi colori
- Bassa emissione di gas tossici.
- Privi di alogeni.
- Non propagante la fiamma
- Resistente a grassi e oli

Coating

- Different for specific applications
- Anchored on the coils
- Smooth or sucked in different colours
- Low emission of toxic gases.
- Halogen-free.
- Flame retardant
- Resistant to oils and greases

Marchatura con riferimenti
di lunghezza progressivi

Marking with references
of progressive length

Grado di protezione IP66/IP67/IP69

Degree of protection IP66/IP67/IP69

■ Caratteristiche tubi

Conduits characteristics

Tipo profilo

Profile type



Semplice aggraffatura

Simple interlocking

Garantisce un'elevata flessibilità e buone caratteristiche meccaniche
Ensures high flexibility and good mechanical characteristics



Aggraffatura rinforzata

Reinforced interlocking

Conferisce al tubo un'elevata resistenza e trazione mantenendo la flessibilità del profilo semplice
Gives the conduit a high strength and traction while maintaining the flexibility of the simple profile



Aggraffatura doppia

Double interlocking

Assicura un'ottima resistenza meccanica e maggiore grado di compressione
Ensures an excellent mechanical strength and greater degree of compression

Tabella riferimenti dimensionali in pollici

Table dimensional references in inches

Rif. nominale pollici Nominal ref. inches	Tubi rigidi Rigid conduits	Tubi pieghevoli/flessibili Flexible conduits
	Diametro ØD (esterno) mm Diameter ØD (external) mm	Diametro Ød (interno) mm Diameter Ød (internal) mm
1/4"	-	10
3/8"	16	12
1/2"	20	16
3/4"	25	21
1"	32	27
1"1/4	40	35
1"1/2	50	40
2"	63	51
2"1/2	75	63
3"	-	75
4"	-	100

Guaina metallica Pliable conduit

Ricoperta in PVC aspirato 6071 Coated in vacuum PVC 6071

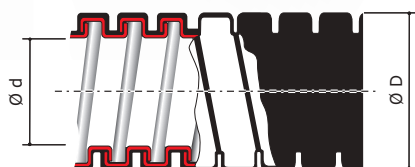

Tubi pieghevoli in acciaio zincato a caldo con metodo Sendzimir (UNI EN 10346) ricoperti in PVC aspirato non propagante la fiamma.

Resistenti ai più comuni oli e grassi, presentano ottima flessibilità e buona resistenza meccanica. Continuità elettrica garantita. Disponibile in Grigio scuro e Nero a richiesta.

- Standard CEI EN 61386-1 e 61386-22
- Classificazione CEI EN 61386 **3 4 3 1**
- Grado IP CEI EN 60529 **IP44**
IP66/IP68/IP69 con accessorio 66BTP
- Resistenza alla compressione
DN10÷DN27 **1250 N**
DN35÷DN51 **750 N**
- Resistenza all'urto **6 J**
- Resistenza alla trazione
DN10÷DN16 **500 N**
DN21÷DN51 **1000 N**
- Resistenza al carico sospeso **450 N**

Pliable conduits made of Sendzimir hot galvanized steel (UNI EN 10346), covered in flame retardant vacuum PVC.

Resistant to most common oils and greases, they are extremely flexible and have excellent levels of mechanical resistance. Electrical continuity guaranteed. Available in dark Grey and Black on request.

- Standard IEC EN 61386-1 and 61386-22
- Classification IEC EN 61386 **3 4 3 1**
- IP degree IEC EN 60529 **IP44**
IP66/IP68/IP69 with accessory 66BTP
- Compressive strength
DN10÷DN27 **1250 N**
DN35÷DN51 **750 N**
- Impact resistance **6 J**
- Tensile strength
DN10÷DN16 **500 N**
DN21÷DN51 **1000 N**
- Resistance to suspended load **450 N**

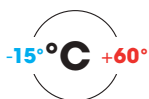

Aggraffatura semplice Simple interlocking



CODICE GRIGIO CODE GRAY	CODICE NERO CODE BLACK	DIAMETRO NOMINALE NOMINAL DIAMETER	DIAMETRO INTERNO INTERNAL DIAMETER mm	DIAMETRO ESTERNO EXTERNAL DIAMETER mm	RAGGIO CURVA RADIUS CURVE mm	CONFEZIONE PACKAGE m
6071-010	6071-010N*	10	10,0	14,0	30	50
6071-012	6071-012N*	12	12,0	16,0	35	50
6071-015	6071-015N*	16	15,5	19,5	40	50

*A richiesta/On request

Aggraffatura rinforzata Reinforced interlocking



CODICE GRIGIO CODE GRAY	CODICE NERO CODE BLACK	DIAMETRO NOMINALE NOMINAL DIAMETER	DIAMETRO INTERNO INTERNAL DIAMETER mm	DIAMETRO ESTERNO EXTERNAL DIAMETER mm	RAGGIO CURVA RADIUS CURVE mm	CONFEZIONE PACKAGE m
6071-020	6071-020N*	21	20,5	25,5	60	50
6071-027	6071-027N*	27	26,5	31,5	80	25
6071-035	6071-035N*	35	35,0	41,0	120	25
6071-040	6071-040N*	40	40,0	46,0	150	25
6071-050	6071-050N*	51	50,5	56,0	200	25

*A richiesta/On request

CEI EN 61386



CEI EN 61386



Accessori correlati Related accessories

Per For
IP66/IP68/IP69



66BTP

6014

6014-G

6014XX

6014-P

6015

6115

6024

6025

6117

6117XX

pag.74

pag. 56

pag. 58

pag. 61

pag. 63

pag. 60

pag. 64

pag.65

pag. 84

pag. 87

Guaina metallica Pliable conduit

Ricoperta in EVA aspirato 6071E Coated in vacuum EVA 6071E



Tubi pieghevoli in nastro di acciaio zincato Sendzimir (UNI EN 10346).
Il rivestimento è realizzato in EVA aspirato, termoplastico non propagante la fiamma, a bassa emissione di gas tossici e corrosivi, privo di alogeni.
Resistenti ai più comuni oli e grassi, presentano ottima flessibilità e buona resistenza meccanica.
Continuità elettrica garantita
Disponibile in Grigio scuro (RAL7043) e Nero a richiesta

Pliable conduits made of Sendzimir galvanized steel (UNI EN 10346).
The coating is made of thermoplastic, flame retardant vacuum EVA, with a low level of toxic and corrosive gas emission, halogen-free.
Resistant to most common oils and greases, they are extremely flexible and have excellent levels of mechanical resistance.
Electrical continuity guaranteed
Available in dark Gray (RAL7043) and Black on request

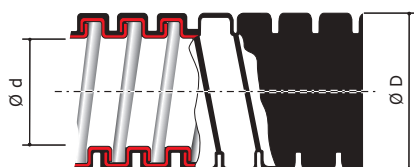

- Standard
CEI EN 61386-1 e 61386-22,
UNI CEI EN 45545-2
- Classificazione CEI EN 61386 3 4 4 1
- Grado IP CEI EN 60529 IP44
IP66/IP68/IP69 con 66BTP
- Resistenza alla compressione
DN10÷DN27 1250 N
DN35÷DN51 750 N
- Resistenza all'urto 6 J
- Resistenza alla trazione
DN10÷DN16 500 N
DN21÷DN51 1000 N
- Resistenza al carico sospeso 450 N
- Emissioni fumi secondo NF F 16-101 F1

- Standard
IEC EN 61386-1 and 61386-22,
UNI IEC EN 45545-2
- Classification IEC EN 61386 3 4 4 1
- IP degree IEC EN 60529 IP44
IP66/IP68/IP69 with 66BTP
- Compressive strength
DN10÷DN27 1250 N
DN35÷DN51 750 N
- Impact resistance 6 J
- Tensile strength
DN10÷DN16 500 N
DN21÷DN51 1000 N
- Resistance to suspended load 450 N
- Fume emissions NF F 16-101 F1

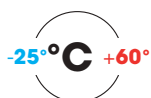

HF
Halogen
FREE

Aggraffatura semplice Simple interlocking



CODICE GRIGIO CODE GRAY	CODICE NERO CODE BLACK a rich./on req.	DIAM. NOMINALE NOMINAL DIAM.	DIAM. INTERNO INTERNAL DIAM. mm	DIAM. ESTERNO EXTERNAL DIAM. mm	RAGGIO CURVA RADIUS CURVE	CONFEZIONE PACKAGE m
6071E-010	6071E-010N*	10	10,0	14,0	30	50
6071E-012	6071E-012N*	12	12,0	16,0	35	50
6071E-015	6071E-015N*	16	15,5	19,5	50	50

*A richiesta/On request

Aggraffatura rinforzata Reinforced interlocking



CODICE GRIGIO CODE GRAY	CODICE NERO CODE BLACK	DIAM. NOMINALE NOMINAL DIAM.	DIAM. INTERNO INTERNAL DIAM. mm	DIAM. ESTERNO EXTERNAL DIAM. mm	RAGGIO CURVA RADIUS CURVE	CONFEZIONE PACKAGE m
6071E-020	6071E-020N*	21	20,5	25,5	65	50
6071E-027	6071E-027N*	27	26,5	31,5	80	25
6071E-035	6071E-035N*	35	35,0	41,0	120	25
6071E-040	6071E-040N*	40	40,0	46,0	150	25
6071E-050	6071E-050N*	51	50,5	56,0	220	25

*A richiesta/On request

CEI EN 61386	
CEI EN 61386	
EN 45545-2 HL3 per R22/R23	

Accessori correlati Related accessories

Per For
IP66/IP68/IP69



66BTP	6014	6014-G	6014XX	6014-P	6015	6115	6024	6025	6117	6117XX
pag.74	pag. 56	pag. 58	pag. 61	pag. 63	pag. 60		pag. 64	pag. 65	pag. 84	pag. 87

■ Guaina metallica Pliable conduit

Ricoperta in Poliuretano aspirato (V0 UL94) 6071PU Coated in vacuum Polyurethane (V0 UL94) 6071PU

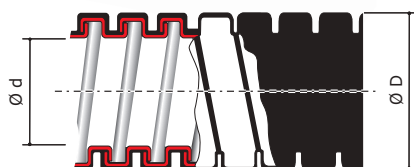

Tubi pieghevoli in acciaio zincato a caldo con metodo Sendzimir (UNI EN 10346) ricoperti in Poliuretano aspirato, non propagante la fiamma, a bassa emissione di gas tossici e corrosivi, privo di alogeni. Resistenti a oli sintetici, inchiostri e grassi, presentano ottima flessibilità e buona resistenza meccanica. Resistenti ai raggi UV, all'abrasione ed alla corrosione anche a temperature molto basse. Idonei per applicazioni esterne. Continuità elettrica garantita. Colore Nero

- Standard
CEI EN 61386-1 e 61386-22
- Classificazione CEI EN 61386 **3 4 5 3**
- Grado IP CEI EN 60529 **IP44**
IP66/IP68/IP69 con accessorio 66BTP
- Resistenza alla compressione
DN10÷DN27 **1250 N**
DN35÷DN51 **750 N**
- Resistenza all'urto **6 J**
- Resistenza alla trazione
DN10÷DN16 **500 N**
DN21÷DN51 **1000 N**
- Resistenza al carico sospeso **450 N**

Pliable conduits in hot galvanized steel with Sendzimir method (UNI EN 10346) coated in flame retardant vacuum polyurethane, with low emission of toxic and corrosive gases, halogens-free. Resistant to synthetic oils, inks and greases, have excellent flexibility and good mechanical resistance. Resistant to UV, abrasion and corrosion even at very low temperatures. Suitable for external applications. Electrical continuity guaranteed. Colour Black

- Standard
IEC EN 61386-1 and 61386-22
- Classification IEC EN 61386 **3 4 5 3**
- IP degree IEC EN 60529 **IP44** -
IP66/IP68/IP69 with accessory 66BTP
- Compressive Strength
DN10÷DN27 **1250 N**
DN35÷DN51 **750 N**
- Impact resistance **6 J**
- Tensile strength
DN10÷DN16 **500 N**
DN21÷DN51 **1000 N**
- Resistance to suspended load **450 N**

Aggraffatura semplice Simple interlocking



CODICE NERO CODE BLACK	DIAMETRO NOMINALE NOMINAL DIAMETER	DIAMETRO INTERNO INTERNAL DIAMETER mm	DIAMETRO ESTERNO EXTERNAL DIAMETER mm	RAGGIO CURVA RADIUS CURVE mm	CONFEZIONE PACKAGE m
6071PU-10N	10	10,0	14,0	30	50
6071PU-12N	12	12,0	16,0	35	50
6071PU-15N	16	15,5	19,5	50	50

Aggraffatura rinforzata Reinforced interlocking



CODICE NERO CODE BLACK	DIAMETRO NOMINALE NOMINAL DIAMETER	DIAMETRO INTERNO INTERNAL DIAMETER mm	DIAMETRO ESTERNO EXTERNAL DIAMETER mm	RAGGIO CURVA RADIUS CURVE mm	CONFEZIONE PACKAGE m
6071PU-20N	21	20,5	25,5	65	50
6071PU-27N	27	26,5	31,5	80	25
6071PU-35N	35	35,0	41,0	120	25
6071PU-40N	40	40,0	46,0	150	25
6071PU-50N	51	50,5	56,0	220	25

Accessori correlati Related accessories

Per For
IP66/IP68/IP69



66BTP	6014	6014-G	6014XX	6014-P	6015	6115	6024	6025	6117	6117XX
pag.74	pag. 56	pag. 58	pag. 61	pag. 63	pag. 60		pag. 64	pag. 65	pag. 84	pag. 87

Guaina metallica Pliable conduit

Ricoperta in PVC liscio 6070 Coated in smooth PVC 6070

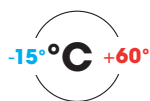
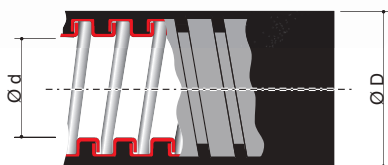
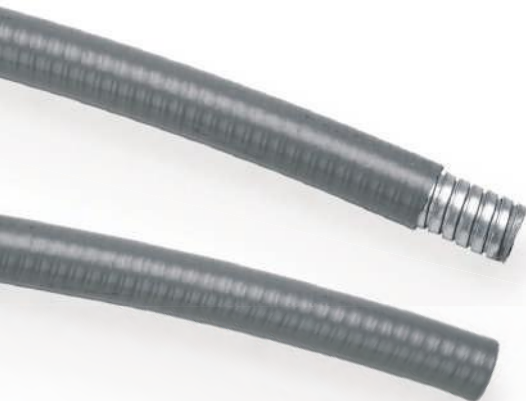

Tubi pieghevoli in nastro di acciaio zincato a caldo con metodo Sendzimir (UNI EN 10346) profilato ad elica a semplice aggraffatura, ricoperti in PVC autoestinguente, con superficie esterna liscia ed ancoraggio sulle spire. Resistenti ai più comuni oli e grassi, presentano ottima flessibilità e buona resistenza meccanica. La marcatura con i riferimenti di lunghezza progressivi agevola le operazioni di spezzatura e consente l'individuazione del materiale residuo nella matassa. Continuità elettrica garantita
Colore grigio e nero

Flexible strip conduits made of hot galvanized steel with Sendzimir method (UNI EN 10346) simple-seaming spiral profiled, covered in flame retardant PVC, with external surface smooth and anchor on the coils. Resistant to most common oils and greases, they are extremely flexible and have excellent levels of mechanical resistance. The marking with the progressive length references facilitates the splitting operations and allows the identification of the residual material in the skein. Electrical continuity guaranteed
Colour gray and black

- Standard
CEI EN 61386-1 e CEI EN 61386-23
- Classificazione CEI EN 61386 3 4 3 1
- Grado IP CEI EN 60529 IP66/IP68/IP69
- Resistenza alla compressione
DN10÷DN27 **1250N**
DN35÷DN51 **750 N**
- Resistenza all'urto **6 J**
- Resistenza alla trazione
DN10÷DN16 **500N**
DN21÷DN51 **1000 N**
- Resistenza al carico sospeso **450 N**

- Standard
IEC EN 61386-1 and IEC EN 61386-23
- Classification IEC EN 61386 3 4 3 1
- IP degree IEC EN 60529 IP66/IP68/IP69
- Compressive strength
DN10÷DN27 **1250N**
DN35÷DN51 **750 N**
- Impact resistance **6 J**
- Tensile strength
DN10÷DN16 **500N**
DN21÷DN51 **1000 N**
- Resistance to suspended load **450 N**

Aggraffatura semplice Simple interlocking



CODICE GRIGIO CODE GRAY	CODICE NERO CODE BLACK	DIAMETRO NOMINALE NOMINAL DIAMETER	DIAMETRO INTERNO INTERNAL DIAMETER	DIAMETRO ESTERNO EXTERNAL DIAMETER	RAGGIO CURVA RADIUS CURVE	CONFEZIONE PACKAGE
			mm	mm	mm	m
6070-10	6070-10N	10	10,0	15	50	50
6070-12	6070-12N	12	12,0	18	60	50
6070-16	6070-16N	16	15,5	21	70	50

Aggraffatura rinforzata Reinforced interlocking



CODICE GRIGIO CODE GRAY	CODICE NERO CODE BLACK	DIAMETRO NOMINALE NOMINAL DIAMETER	DIAMETRO INTERNO INTERNAL DIAMETER	DIAMETRO ESTERNO EXTERNAL DIAMETER	RAGGIO CURVA RADIUS CURVE	CONFEZIONE PACKAGE
			mm	mm	mm	m
6070-22	6070-22N	21	20,5	27	90	50
6070-32	6070-32N	27	26,5	34	120	25
6070-38	6070-38N	35	35,0	43	150	25
6070-40	6070-40N	40	40,0	48	200	25
6070-50	6070-50N	51	50,5	58,5	250	25
6070-10R*	-	10	10	15	60	50
6070-12R*	-	12	12	18	70	50
6070-16R*	-	16	15,5	21	80	50

* A richiesta e resistenza alla trazione 1000N
*Tensile strength 1000N and on request

Accessori correlati Related accessories

6014	6014-G	6014XX	6014-P	6015	6115	6024	6025	6117	6117XX
pag. 56	pag. 58	pag. 61	pag. 63	pag. 60	pag. 64	pag. 65	pag. 84	pag. 87	

Guaina metallica Pliable conduit

Ricoperta in EVA liscio 607E Coated in smooth EVA 607E

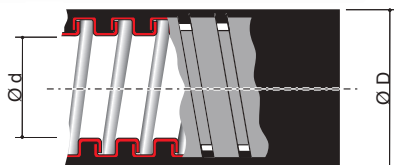

Tubi pieghevoli in nastro di acciaio zincato Sendzimir (UNI EN 10346).
Il rivestimento è realizzato in EVA, termoplastico non propagante la fiamma, a bassa emissione di gas tossici e corrosivi, privo di alogeni, con superficie esterna liscia ed ancoraggio sulle spire.
Resistenti ai più comuni oli e grassi, presentano buona flessibilità e buona resistenza meccanica.
Continuità elettrica garantita
Colore grigio e nero a richiesta

Pliable conduits made of Sendzimir galvanized steel (UNI EN 10346).
The coating is made of thermoplastic, flame retardant EVA, with a low level of toxic and corrosive gas emission, halogen-free, with a smooth external surface and thread fastening.
Resistant to most common oils and greases, they are extremely flexible and have excellent levels of mechanical resistance.
Electrical continuity guaranteed
Colour grey and black on request

- Standard
CEI EN 61386-1, CEI EN 61386-2, UNI CEI EN 45545-2
- Classificazione CEI EN 61386 **3 4 4 1**
- Grado IP CEI EN 60529 **IP66/IP68/IP69**
- Resistenza alla compressione
DN10÷DN27 **1250N**
DN35÷DN51 **750 N**
- Resistenza all'urto **6 J**
- Resistenza alla trazione
DN10÷DN16 **500N**
DN21÷DN51 **1000 N**
- Resistenza al carico sospeso **450 N**

- Standard
IEC EN 61386-1 and 61386-2, UNI IEC EN 45545-2
- Classificazione IEC EN 61386 **3 4 4 1**
- IP degree IEC EN 60529 **IP66/IP68/IP69**
- Compressive strength
DN10÷DN27 **1250N**
DN35÷DN51 **750 N**
- Impact resistance **6 J**
- Tensile strength
DN10÷DN16 **500N**
DN21÷DN51 **1000 N**
- Resistance to suspended load **450 N**

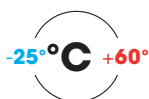

HF
Halogen
FREE

Aggraffatura semplice Simple interlocking



CODICE GRIGIO CODE GRAY	CODICE NERO CODE BLACK	DIAM. NOMINALE NOMINAL DIAM.	DIAM. INTERNO INTERNAL DIAM. mm	DIAM. ESTERNO EXTERNAL DIAM. mm	RAGGIO CURVA RADIUS CURVE	CONFEZIONE PACKAGE m
607E010	607E010N*	10	10,0	15,0	60	50
607E012	607E012N*	12	12,0	18,0	70	50
607E016	607E016N*	16	15,5	21,0	90	50

Aggraffatura rinforzata Reinforced interlocking



CODICE GRIGIO CODE GRAY	CODICE NERO CODE BLACK	DIAM. NOMINALE NOMINAL DIAM.	DIAM. INTERNO INTERNAL DIAM. mm	DIAM. ESTERNO EXTERNAL DIAM. mm	RAGGIO CURVA RADIUS CURVE	CONFEZIONE PACKAGE m
607E022	607E022N*	21	20,5	27,0	120	25
607E032	607E032N*	27	26,5	34,0	140	25
607E038	607E038N*	35	35,0	43,0	190	25
607E040	607E040N*	40	40,0	48,0	240	25
607E050	607E050N*	51	50,5	58,5	300	25
607E010R**	-	10	10,0	15,0	70	50
607E012R**	-	12	12,0	18,0	80	50
607E016R**	-	16	15,5	21,0	100	50

*A richiesta/On request
** Resistenza alla trazione 1000N e a richiesta
** 1000N Tensile strength and on request

Accessori correlati Related accessories

6014	6014-G	6014XX	6014-P	6015	6115	6024	6025	6117	6117XX
pag. 56	pag. 58	pag. 61	pag. 63	pag. 60	pag. 64	pag. 65	pag. 84	pag. 87	

■ Guaina metallica Pliable conduit

A doppia aggraffatura ricoperta in PVC liscio 607D Double interlocking coated in smooth PVC 607D

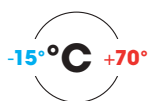
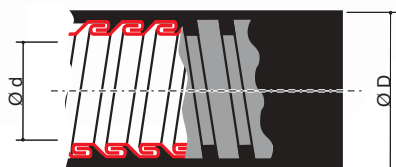

Tubi pieghevoli in acciaio zincato a caldo con metodo Sendzimir (UNI EN 10346) profilato ad elica a doppia aggraffatura, ricoperti in PVC non propagante la fiamma, liscio esternamente e con ancoraggio sulle spire.

Resistenti ai più comuni oli e grassi, presentano una buona flessibilità ed ottima resistenza meccanica in modo particolare per le sollecitazioni a trazione. Continuità elettrica garantita. Colore Nero e Grigio chiaro

- Standard
CEI EN 61386-1, CEI EN 61386-22
- Classificazione CEI EN 61386 **4 4 3 1**
- Grado IP CEI EN 60529 **IP66/IP68/IP69**
- Resistenza alla compressione **1250 N**
- Resistenza all'urto **6 J**
- Resistenza alla trazione **1000 N**
- Resistenza al carico sospeso **450 N**

Pliable conduits in hot galvanized steel with Sendzimir method (UNI EN 10346) double-seaming spiral profiled, externally coated in smooth flame retardant PVC with thread fastening.

Resistant to most types of oils and greases, they have good flexibility and a really good mechanical resistance when subjected to traction stresses. Electrical continuity guaranteed. Colour Black and light Grey

- Standard
IEC EN 61386-1 and 61386-22
- Classification IEC EN 61386 **4 4 3 1**
- IP degree IEC EN 60529 **IP66/IP68/IP69**
- Compressive strength **1250N**
- Impact resistance **6 J**
- Tensile strength **1000 N**
- Resistance to suspended load **450 N**

Aggraffatura doppia Double interlocking



CODICE GRIGIO CODE GRAY	CODICE NERO CODE BLACK	DIAMETRO NOMINALE NOMINAL DIAMETER	DIAMETRO INTERNO INTERNAL DIAMETER mm	DIAMETRO ESTERNO EXTERNAL DIAMETER mm	RAGGIO CURVA RADIUS CURVE mm	CONFEZIONE PACKAGE m
607D-10	607D-10N	10	10,0	15,0	60	50
607D-12	607D-12N	12	12,0	18,0	70	50
607D-16	607D-16N	16	15,5	21,0	90	50
607D-22	607D-22N	21	20,5	27,0	120	50
607D-32	607D-32N	27	26,5	34,0	140	25
607D-38	607D-38N	35	35,0	43,0	190	25
607D-40	607D-40N	40	40,0	48,0	240	25
607D-50	607D-50N	51	50,5	58,5	300	25
607D-63	607D-63N	63	63,0	74,0	450	12
607D-75	607D-75N	75	75,0	84,0	500	8
607D-100	607D-100N	100	100,0	109,0	750	8

Accessori correlati Related accessories

6014	6014-G	6014XX	6014-P	6015	6115	6024	6025	6117	6117XX
pag. 56	pag. 58	pag. 61	pag. 63	pag. 60	pag. 64	pag. 65	pag. 84	pag. 87	

■ Guaina metallica Pliable conduit

A doppia aggraffatura INOX AISI 304 ricoperta in PVC liscio **607DX** Double interlocking Stainless Steel AISI 304 coated in smooth PVC **607DX**

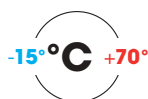
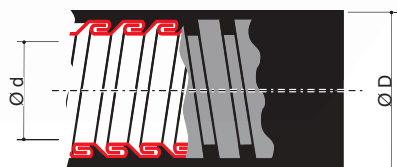

Tubi pieghevoli in acciaio INOX AISI 304 a doppia aggraffatura, ricoperti in PVC non propagante la fiamma, liscio esternamente e con ancoraggio sulle spire. Resistenti ai più comuni oli e grassi, presentano una buona flessibilità ed ottima resistenza meccanica in modo particolare per le sollecitazioni a trazione. Continuità elettrica garantita
Prodotto a commessa per lotti minimi.

Double interlocking AISI 304 stainless steel pliable conduit, coated in flame retardant PVC externally smooth and with anchorage on the coils. Resistant to most types of oils and greases, they have good flexibility and a really good mechanical resistance when subjected to traction stresses. Electrical continuity guaranteed
Produced on request in minimum lots.

- Standard
CEI EN 61386-1 e CEI EN 61386-22
- Classificazione CEI EN 61386 **4 4 3 1**
- Grado IP CEI EN 60529 **IP66/IP68/IP69**
- Resistenza alla compressione **1250 N**
- Resistenza all'urto **6 J**
- Resistenza alla trazione **1000 N**
- Resistenza al carico sospeso **450 N**

- Standard
IEC EN 61386-1 and 61386-22
- Classification IEC EN 61386 **4 4 3 1**
- IP degree IEC EN 60529 **IP66/IP68/IP69**
- Compressive strength **1250 N**
- Impact resistance **6 J**
- Tensile strength **1000 N**
- Resistance to suspended load **450 N**

Aggraffatura doppia Double interlocking



CODICE CODE	DIAMETRO NOMINALE NOMINAL DIAMETER	DIAMETRO INTERNO INTERNAL DIAMETER	DIAMETRO ESTERNO EXTERNAL DIAMETER	RAGGIO CURVA RADIUS CURVE	CONFEZIONE PACKAGE
AISI 304		mm	mm	mm	m
607DX-10*	10	10,0	15,0	60	50
607DX-12*	12	12,0	18,0	70	50
607DX-16*	16	15,5	21,0	90	50
607DX-22*	21	20,5	27,0	120	50
607DX-32*	27	26,5	34,0	140	25
607DX-38*	35	35,0	43,0	190	25
607DX-40*	40	40,0	48,0	240	25
607DX-50*	51	50,5	58,5	300	25

* A richiesta / On request

Accessori correlati Related accessories

6014	6014-G	6014XX	6014-P	6015	6115	6024	6025	6117	6117XX
pag. 56	pag. 58	pag. 61	pag. 63	pag. 60	pag. 64	pag. 65	pag. 84	pag. 87	

■ Guaina metallica Pliable conduit

A doppia aggraffatura INOX AISI 316L ricoperta in PVC liscio 607DXX Double interlocking Stainless Steel AISI 316L coated in smooth PVC 607DXX

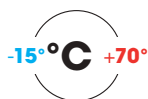
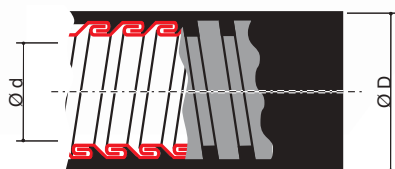

Tubi pieghevoli in acciaio INOX AISI 316L a doppia aggraffatura, ricoperti in PVC non propagante la fiamma, liscio esternamente e con ancoraggio sulle spire. Resistenti ai più comuni oli e grassi, presentano una buona flessibilità ed ottima resistenza meccanica in modo particolare per le sollecitazioni a trazione. Continuità elettrica garantita
Prodotto a commessa per lotti minimi.

Double interlocking AISI 316L stainless steel pliable conduit, coated in flame retardant PVC externally smooth and with anchorage on the coils. Resistant to most types of oils and greases, they have good flexibility and a really good mechanical resistance when subjected to traction stresses. Electrical continuity guaranteed
Produced on request in minimum lots.

- Standard
CEI EN 61386-1 e CEI EN 61386-22
- Classificazione CEI EN 61386 **4 4 3 1**
- Grado IP CEI EN 60529 **IP66/IP68/IP69**
- Resistenza alla compressione **1250 N**
- Resistenza all'urto **6 J**
- Resistenza alla trazione **1000 N**
- Resistenza al carico sospeso **450 N**

- Standard
IEC EN 61386-1 and 61386-22
- Classification IEC EN 61386 **4 4 3 1**
- IP degree IEC EN 60529 **IP66/IP68/IP69**
- Compressive strength **1250N**
- Impact resistance **6 J**
- Tensile strength **1000 N**
- Resistance to suspended load **450 N**

Aggraffatura doppia Double interlocking



CODICE CODE	DIAMETRO NOMINALE NOMINAL DIAMETER	DIAMETRO INTERNO INTERNAL DIAMETER	DIAMETRO ESTERNO EXTERNAL DIAMETER	RAGGIO CURVA RADIUS CURVE	CONFEZIONE PACKAGE
AISI 316L		mm	mm	mm	m
607DXX-10*	10	10,0	15,0	60	50
607DXX-12*	12	12,0	18,0	70	50
607DXX-16*	16	15,5	21,0	90	50
607DXX-22*	21	20,5	27,0	120	50
607DXX-32*	27	26,5	34,0	140	25
607DXX-38*	35	35,0	43,0	190	25
607DXX-40*	40	40,0	48,0	240	25
607DXX-50*	51	50,5	58,5	300	25

* A richiesta / On request

Accessori correlati Related accessories

	6014	6014-G	6014XX	6014-P	6015	6115	6024	6025	6117	6117XX
	pag. 56	pag. 58	pag. 61	pag. 63	pag. 60	pag. 64	pag. 65	pag. 84	pag. 87	

■ Guaina metallica Pliable conduit

A doppia aggraffatura ricoperta in poliuretano liscio **607PU** Double interlocking covered in smooth polyurethane **607PU**

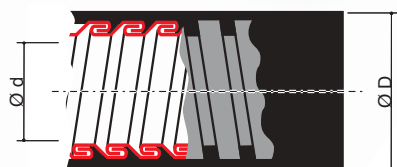

Tubi pieghevoli in acciaio zincato Sendzimir (UNI EN 10346) a doppia aggraffatura. Rivestimento realizzato in poliuretano non propagante la fiamma a bassa emissione di gas tossici e corrosivi, privo di alogeni, con superficie esterna liscia ed ancoraggio sulle spire.

Resistenti agli inchiostri, oli sintetici e grassi, ottima resistenza meccanica in particolare alle sollecitazioni a trazione. Resistenti ai raggi UV, all'abrasione ed alla corrosione anche a temperature molto basse, sono idonei per applicazioni all'esterno. Continuità elettrica garantita
Colore Nero

Double interlocking conduits in galvanized steel with Sendzimir method (UNI EN 10346).

Coating made of flame retardant polyurethane with a low level of toxic and corrosive gas emission, halogen-free, with a smooth external surface and thread fastening.

These conduits are resistant to inks, synthetic oils and grease and have excellent flexibility and really good mechanical resistance when subjected to traction stresses.

Resistant to UV rays, abrasion and corrosion, even at very low temperatures, these conduits are suitable for outdoor applications.

Electrical continuity guaranteed
Colour Black

- Standard
CEI EN 61386-1, CEI EN61386-22
- Classificazione CEI EN 61386 **4 4 5 3**
- Grado IP CEI EN 60529 **IP66/IP68/IP69**
- Resistenza alla compressione **1250 N**
- Resistenza all'urto **6 J**
- Resistenza alla trazione **1000 N**
- Resistenza al carico sospeso **450 N**

- Standard
IEC EN 61386-1 and 61386-22
- Classification IEC EN 61386 **4 4 5 3**
- IP degree IEC EN 60529 **IP66/IP68/IP69**
- Compressive strength **1250N**
- Impact resistance **6 J**
- Tensile strength **1000 N**
- Resistance to suspended load **450 N**



HF
Halogen
FREE

Aggraffatura doppia Double interlocking



CODICE CODE	DIAMETRO NOMINALE NOMINAL DIAMETER	DIAMETRO INTERNO INTERNAL DIAMETER mm	DIAMETRO ESTERNO EXTERNAL DIAMETER mm	RAGGIO CURVA CURVE RADIUS mm	CONFEZIONE PACKAGE m
607PU10N	10	10,0	15,0	60	50
607PU12N	12	12,0	18,0	70	50
607PU16N	16	15,5	21,0	90	50
607PU22N	21	20,5	27,0	120	50
607PU32N	27	26,5	34,0	140	25
607PU38N	35	35,0	43,0	190	25
607PU40N	40	40,0	48,0	240	25
607PU50N	51	50,5	58,5	300	25

Accessori correlati Related accessories

6014	6014-G	6014XX	6014-P	6015	6115	6024	6025	6117	6117XX
pag. 56	pag. 58	pag. 61	pag. 63	pag. 60	pag. 64	pag. 65	pag. 84	pag. 87	

■ Guaina metallica Pliable conduit

A doppia aggraffatura ricoperta in TPE liscio 607DBT Double interlocking coated in smooth TPE 607DBT

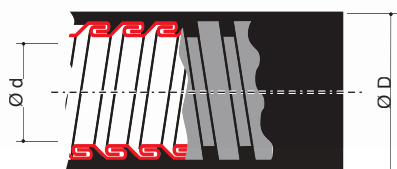

Tubi pieghevoli ricavati da nastro di acciaio zincato Sendzimir (UNI EN10346) profilato a doppia aggraffatura, ricoperti in TPE autoestinguente, liscio esternamente e con ancoraggio sulle spire.

Resistenti ai più comuni oli e grassi, presentano una buona flessibilità ed ottima resistenza meccanica in particolare per le sollecitazioni a trazione. Idonei per applicazioni in condizioni ambientali gravose, particolarmente indicati per impieghi a elevate temperature.

Continuità elettrica garantita
Colore Nero

Double interlocking conduits in galvanized steel with Sendzimir method (UNI EN 10346), externally coated in smooth and self-extinguishing TPE.

Resistant to most types of oils and greases, they present a good flexibility and a really good mechanical resistance when subjected to traction stresses.

Suitable for applications in harsh environmental conditions, especially for use at high temperatures.

Electrical continuity guaranteed
Colour black

- Standard
CEI EN 61386-1, CEI EN61386-22
- Classificazione CEI EN 61386 4 4 4 4
- Grado IP CEI EN 60529 IP66/IP68/IP69
- Resistenza alla compressione 1250 N
- Resistenza all'urto 6 J
- Resistenza alla trazione 1000 N
- Resistenza al carico sospeso 450 N

- Standard
IEC EN 61386-1 and 61386-22,
- Classification IEC EN 61386 4 4 4 4
- IP degree IEC EN 60529 IP66/IP68/IP69
- Compressive strength 1250N
- Impact resistance 6 J
- Tensile strength 1000 N
- Resistance to suspended load 450 N

Aggraffatura doppia Double interlocking



CODICE CODE	DIAMETRO NOMINALE	DIAMETRO INTERNO	DIAMETRO ESTERNO	RAGGIO CURVA	CONFEZIONE
	NOMINAL DIAMETER	INTERNAL DIAMETER	EXTERNAL DIAMETER	RADIUS CURVE	PACKAGE
		mm	mm	mm	m
607DBT22*	21	20,5	27,0	90	50
607DBT32*	27	26,5	34,0	110	25
607DBT38*	35	35,0	43,0	130	25
607DBT40*	40	40,0	48,0	160	25
607DBT50*	51	50,5	58,5	200	25
607DBT63*	63	63,0	74,0	300	12

* A richiesta / On request

Accessori correlati Related accessories

6014	6014-G	6014XX	6014-P	6015	6115	6024	6025	6117	6117XX
pag. 56	pag. 58	pag. 61	pag. 63	pag. 60	pag. 64	pag. 65	pag. 84	pag. 87	

■ Guaina metallica Pliable conduit

Ricoperta in PVC aspirato protetta con treccia metallica 6071T Covered in vacuum PVC protected with metal braid 6071T

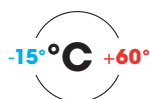
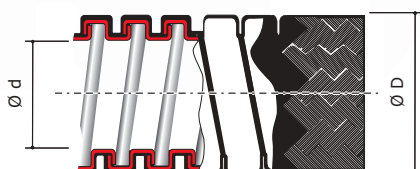

Tubi pieghevoli in acciaio zincato a caldo con metodo Sendzimir (UNI EN 10346) ricoperti in PVC non propagante la fiamma, aspirato, protetti con treccia di acciaio zincato che conferisce un'elevata resistenza all'usura.

Resistenti ai più comuni oli e grassi, presentano ottima flessibilità e buona resistenza meccanica. Offrono una buona protezione dalle interferenze elettromagnetiche su un'ampia banda di frequenze. Continuità elettrica garantita. Colore distintivo treccia Blu

- Standard
CEI EN 61386-1 CEI EN 61386-22
- Classificazione CEI EN 61386 **3 4 3 1**
- Grado IP CEI EN 60529 **IP44**
IP66/IP68 - IP69 con raccordi T1
- Resistenza alla compressione
DN10÷DN27 **1250 N**
DN35÷DN51 **750 N**
- Resistenza all'urto **6 J**
- Resistenza alla trazione
DN10÷DN16 **500 N**
DN21÷DN51 **1000 N**
- Resistenza al carico sospeso **450 N**
- Schermatura EMC secondo
IEC TS 61587: 30-230MHz
Livello1 (Abbattimento min. 35dB)

Pliable conduits in hot galvanized steel with Sendzimir method (UNI EN 10346), coated in flame retardant vacuum PVC, protected with galvanized steel wire braid which provides high resistance to wear. Resistant to most common oils and greases, they are extremely flexible and have excellent levels of mechanical resistance. They offer a good protection from electromagnetic interferences over a wide band of frequencies.

Electrical continuity guaranteed
Distinctive colour blue braid

- Standard
IEC EN 61386-1 and 61386-22
- Classification IEC EN 61386 **3 4 3 1**
- IP degree IEC EN 60529 **IP44**
IP66/IP68 - IP69 with fittings T1
- Compressive strength
DN10÷DN27 **1250 N**
DN35÷DN51 **750 N**
- Impact resistance **6 J**
- Tensile strength
DN10÷DN16 **500 N**
DN21÷DN51 **1000 N**
- Resistance to suspended load **450 N**
- EMC shielding in compliance with
IEC TS 61587:30-230MHz
Level 1 (Minimum abatement 35dB)

Aggraffatura semplice Simple interlocking



CODICE CODE	DIAMETRO NOMINALE NOMINAL DIAMETER	DIAMETRO INTERNO INTERNAL DIAMETER mm	DIAMETRO ESTERNO EXTERNAL DIAMETER mm	RAGGIO CURVA RADIUS CURVE	CONFEZIONE PACKAGE m
6071T-010	10	10,0	16,0	30	50
6071T-012	12	12,0	18,0	35	50
6071T-016	16	15,5	21,0	50	50

Aggraffatura rinforzata Reinforced interlocking



CODICE CODE	DIAMETRO NOMINALE NOMINAL DIAMETER	DIAMETRO INTERNO INTERNAL DIAMETER mm	DIAMETRO ESTERNO EXTERNAL DIAMETER mm	RAGGIO CURVA RADIUS CURVE	CONFEZIONE PACKAGE m
6071T-022	21	20,5	27,0	65	50
6071T-032	27	26,5	33,0	80	25
6071T-038	35	35,0	42,0	120	25
6071T-040	40	40,0	47,0	150	25
6071T-050	51	50,5	58,0	220	25

IEC TS 61587



Accessori correlati Related accessories

6014	6014-G	6014XX	6014-P	6015	6115	6024	6025	6117	6117XX	Series Series T
pag. 56	pag. 58	pag. 61	pag. 63	pag. 60	pag. 64	pag. 65	pag. 84	pag. 87	pag. 68/69	T1

Guaina metallica Pliable conduit

Ricoperta in PVC aspirato protetta con treccia INOX AISI 304 6071TX Covered in vacuum PVC protected with AISI 304 stainless steel braid 6071TX

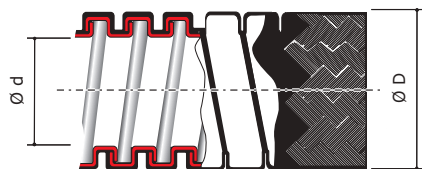

Tubi pieghevoli in acciaio zincato a caldo con metodo Sendzimir (UNI EN 10346) ricoperti in PVC non propagante la fiamma, aspirato, protetti con treccia di acciaio ino: AISI 304 che conferisce un'elevata resistenza all'usura. Resistenti ai più comuni oli e grassi, presentano ottima flessibilità e buona resistenza meccanica. Offrono una buona protezione dalle interferenze elettromagnetiche su un'ampia banda di frequenze. Continuità elettrica garantita

Pliable conduits in hot galvanized steel with Sendzimir method (UNI EN 10346), coated in flame retardant PVC, protected with AISI 304 stainless steel braid that provides high resistance against wear. Resistant to most common oils and greases, they are extremely flexible and have excellent levels of mechanical resistance. They offer a good protection from electromagnetic interferences over a wide band of frequencies. Electrical continuity guaranteed

- Standard
CEI EN 61386-1 CEI EN 61386-22
- Classificazione CEI EN 61386 **3 4 3 1**
- Grado IP CEI EN 60529 **IP44**
- **IP66/IP68 - IP69 con raccordi T1**
- Resistenza alla compressione
DN10÷DN27 **1250 N**
DN35÷DN51 **750 N**
- Resistenza all'urto **6 J**
- Resistenza alla trazione
DN10÷DN16 **500 N**
DN21÷DN51 **1000 N**
- Resistenza al carico sospeso **450 N**
- Schermatura EMC secondo
IEC TS 61587: 30-230MHz
Livello1 (Abbattimento min. 35dB)

- Standard
IEC EN 61386-1 and 61386-22
- Classification IEC EN 61386 **3 4 3 1**
- IP degree IEC EN 60529 **IP44**
- **IP66/IP68 - IP69 with fittings T1**
- Compressive strength
DN10÷DN27 **1250 N**
DN35÷DN51 **750 N**
- Impact resistance **6 J**
- Tensile strength
DN10÷DN16 **500 N**
DN21÷DN51 **1000 N**
- Resistance to suspended load **450 N**
- EMC shielding in compliance with IEC TS 61587: 30-230MHz
Level 1 (Minimum abatement 35dB)

Aggraffatura semplice Simple interlocking



CODICE CODE	DIAMETRO NOMINALE NOMINAL DIAMETER mm	DIAMETRO INTERNO INTERNAL DIAMETER mm	DIAMETRO ESTERNO EXTERNAL DIAMETER mm	RAGGIO CURVA CURVE RADIUS	CONFEZIONE PACKAGE m
6071TX010*	10	10,0	16,0	30	50
6071TX012*	12	12,0	18,0	35	50
6071TX016*	16	15,5	21,0	50	50

* A richiesta / On request

Aggraffatura rinforzata Reinforced interlocking



CODICE CODE	DIAMETRO NOMINALE NOMINAL DIAMETER mm	DIAMETRO INTERNO INTERNAL DIAMETER mm	DIAMETRO ESTERNO EXTERNAL DIAMETER mm	RAGGIO DI CURVA CURVE RADIUS	CONFEZIONE PACKAGE m
6071TX022*	21	20,5	27,0	65	50
6071TX032*	27	26,5	33,0	80	25
6071TX038*	35	35,0	42,0	120	25
6071TX040*	40	40,0	47,0	150	25
6071TX050*	51	50,5	58,0	220	25

* A richiesta / On request

Accessori correlati Related accessories

6014	6014-G	6014XX	6014-P	6015	6115	6024	6025	6117	6117XX	Series Series T
pag. 56	pag. 58	pag. 61	pag. 63	pag. 60	pag. 64	pag. 65	pag. 84	pag. 87	pag. 68/69	

■ Guaina metallica Pliable conduit

Ricoperta in EVA aspirata protetta con treccia metallica 6071ET Coated in vacuum EVA protected by metal braid 6071ET

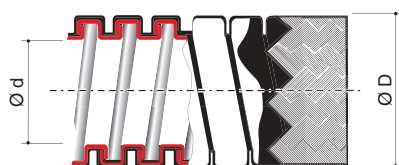

-25°C +70°C



HF
Halogen
FREE

EN 45545-2
HL3 per R22/R23



IEC TS 61587



Tubi pieghevoli in nastro di acciaio zincato Sendzimir (UNI EN 10346).

Rivestimento in EVA aspirato, termoplastico non propagante la fiamma, a bassa emissione di gas tossici e corrosivi, privo di alogeni.

Protetti da treccia metallica in acciaio zincato, che ne conferisce una elevata resistenza all'usura, all'abrasione ed allo scintillio. Resistenti ai più comuni oli e grassi, presentano ottima flessibilità e buona resistenza meccanica. Offrono una buona protezione dalle interferenze elettromagnetiche su un'ampia banda di frequenze. Continuità elettrica garantita
Colore distintivo treccia verde

- Standard
**CEI EN 61386-1 e 61386-22,
UNI CEI EN 45545-2**
- Classificazione CEI EN 61386 **3 4 4 1**
- Grado IP CEI EN 60529 **IP44
IP66/IP68 - IP69 con raccordi T1**
- Resistenza alla compressione
DN10÷DN27 **1250 N**
DN35÷DN51 **750 N**
- Resistenza all'urto **6 J**
- Resistenza alla trazione
DN10÷DN16 **500 N**
DN21÷DN51 **1000 N**
- Resistenza al carico sospeso **450 N**
- Emissioni fumi secondo NF F 16-101 **F1**
- Schermatura EMC IEC TS
61587: 30-230MHz:
Livello1 (Abbattimento min. 35dB)

Pliable conduits made of Sendzimir galvanised steel (UNI EN 10346).

The coating is made of thermoplastic flame retardant vacuum EVA with low level of toxic and corrosive gas emission and halogen-free.

They are protected by a galvanised steel braid which makes them highly resistant to wear, abrasion and electric sparks. Resistant to most common oils and greases, they are extremely flexible and have excellent levels of mechanical resistance. They offer a good protection from electromagnetic interferences over a wide band of frequencies.

Electrical continuity guaranteed
Distinctive braid colour green

- Standard
**IEC EN 61386-1 and 61386-22,
UNI IEC 1170-3:2005**
- Classification IEC EN 61386 **3 4 4 1**
- IP degree IEC EN 60529 **IP44
IP66/IP68 - IP69 with fittings T1**
- Compressive strength
DN10÷DN27 **1250 N**
DN35÷DN51 **750 N**
- Impact resistance **6 J**
- Tensile strength
DN10÷DN16 **500 N**
DN21÷DN51 **1000 N**
- Resistance to suspended load **450 N**
- Fume emissions NF F 16-101 **F1**
- Shielding in compliance with
IEC TS 61587: 30-230 MHz
Level 1 (Minimum abatement 35dB)

Aggraffatura semplice Simple interlocking



CODICE CODE	DIAMETRO NOMINALE NOMINAL DIAMETER	DIAMETRO INTERNO INTERNAL DIAMETER mm	DIAMETRO ESTERNO EXTERNAL DIAMETER mm	RAGGIO CURVA RADIUS CURVE	CONFEZIONE PACKAGE m
6071ET-010	10	10,0	16,0	30	50
6071ET-012	12	12,0	18,0	35	50
6071ET-016	16	15,5	21,0	50	50

Aggraffatura rinforzata Reinforced interlocking



CODICE CODE	DIAMETRO NOMINALE NOMINAL DIAMETER	DIAMETRO INTERNO INTERNAL DIAMETER mm	DIAMETRO ESTERNO EXTERNAL DIAMETER mm	RAGGIO CURVA RADIUS CURVE	CONFEZIONE PACKAGE m
6071ET-022	21	20,5	27,0	65	50
6071ET-032	27	26,5	33,0	80	25
6071ET-038	35	35,0	42,0	120	25
6071ET-040	40	40,0	47,0	150	25
6071ET-050	51	50,5	58,0	220	25

Accessori correlati Related accessories



Series Series

T

6014

6014-G

6014XX

6014-P

6015

6115

6024

6025

6117

6117XX

T1

pag. 56

pag. 58

pag. 61

pag. 63

pag. 60

pag. 64

pag. 65

pag. 84

pag. 87

pag. 68/69

■ Guaina metallica Pliable conduit

Ricoperta in EVA aspirata protetta con treccia inox AISI 304 **6071ETX** Coated in vacuum EVA protected with stainless steel AISI 304 braid **6071ETX**

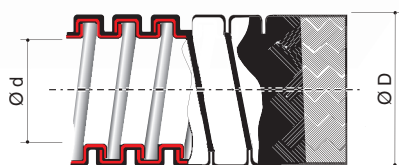

HF
Halogen
FREE

EN 45545-2
HL3 per R22/R23



IEC TS 61587



Tubi pieghevoli in nastro di acciaio zincato Sendzimir (UNI EN 10346).

Rivestimento in EVA aspirato, termoplastico non propagante la fiamma, a bassa emissione di gas tossici e corrosivi, privo di alogeni.

Protetti da treccia metallica in acciaio inox AISI 304, che ne conferisce una elevata resistenza all'usura, all'abrasione ed allo scintillio. Resistenti ai più comuni oli e grassi, presentano ottima flessibilità e buona resistenza meccanica. Offrono una buona protezione dalle interferenze elettromagnetiche su un'ampia banda di frequenze.

Continuità elettrica garantita

■ Standard

**CEI EN 61386-1 e 61386-22,
UNI CEI EN 45545-2**

■ Classificazione CEI EN 61386 **3 4 4 1**

■ Grado IP CEI EN 60529 **IP44
IP66/IP68 - IP69 con raccordi T1**

■ Resistenza alla compressione
DN10÷DN27 **1250 N**
DN35÷DN51 **750 N**

■ Resistenza all'urto **6 J**

■ Resistenza alla trazione
DN10÷DN16 **500 N**
DN21÷DN51 **1000 N**

■ Resistenza al carico sospeso **450 N**

■ Emissioni fumi secondo NF F 16-101 **F1**

■ Schermatura EMC IEC TS
61587: 30-230MHz:

Livello1 (Abbattimento min. 35dB)

Pliable conduits made of Sendzimir galvanized steel (UNI EN 10346).

The coating is made of thermoplastic flame retardant vacuum EVA with low level of toxic and corrosive gas emission and halogen-free.

They are protected by AISI 304 stainless steel braid which gives them a high resistance to wear and abrasion and to sparkle. Resistant to most common oils and greases, they are extremely flexible and have excellent levels of mechanical resistance. They offer a good protection from electromagnetic interferences over a wide band of frequencies.

Electrical continuity guaranteed

■ Standard

**IEC EN 61386-1 and 61386-22,
UNI IEC 1170-3:2005**

■ Classificazione IEC EN 61386 **3 4 4 1**

■ IP degree IEC EN 60529 **IP44
IP66/IP68 - IP69 with fittings T1**

■ Compressive strength
DN10÷DN27 **1250 N**
DN35÷DN51 **750 N**

■ Impact resistance **6 J**

■ Tensile strength
DN10÷DN16 **500 N**
DN21÷DN51 **1000 N**

■ Resistance to suspended load **450 N**

■ Smoke emissions NF F 16-101 **F1**

■ EMC shielding in compliance with
IEC TS 61587: 30-230 MHz

Level 1 (Minimum abatement 35dB)

Aggraffatura semplice Simple interlocking



CODICE CODE	DIAMETRO NOMINALE NOMINAL DIAMETER	DIAMETRO INTERNO INTERNAL DIAMETER mm	DIAMETRO ESTERNO EXTERNAL DIAMETER mm	RAGGIO CURVA RADIUS CURVE	CONFEZIONE PACKAGE m
6071ETX-010*	10	10,0	16,0	30	50
6071ETX-012*	12	12,0	18,0	35	50
6071ETX-016*	16	15,5	21,0	50	50

* A richiesta / On request

Aggraffatura rinforzata Reinforced interlocking



CODICE CODE	DIAMETRO NOMINALE NOMINAL DIAMETER	DIAMETRO INTERNO INTERNAL DIAMETER mm	DIAMETRO ESTERNO EXTERNAL DIAMETER mm	RAGGIO CURVA RADIUS CURVE	CONFEZIONE PACKAGE m
6071ETX-022*	21	20,5	27,0	65	50
6071ETX-032*	27	26,5	33,0	80	25
6071ETX-038*	35	35,0	42,0	120	25
6071ETX-040*	40	40,0	47,0	150	25
6071ETX-050*	51	50,5	58,0	220	25

* A richiesta / On request

Accessori correlati Related accessories



Serie Series

T

6014	6014-G	6014XX	6014-P	6015	6115	6024	6025	6117	6117XX	T1
pag. 56	pag. 58	pag. 61	pag. 63	pag. 60	pag. 64	pag. 65	pag. 84	pag. 87	pag. 68/69	

■ Guaina metallica Pliable conduit

Ricoperta in EVA liscio e protetta con treccia INOX AISI 304 607ETX

Coated in smooth EVA and protected with AISI 304 stainless steel braid 607ETX



Tubi pieghevoli in acciaio zincato Sendzimir (UNI EN 10346). Rivestimento in EVA, termoplastico, non propagante la fiamma, a bassa emissione di gas tossici, corrosivi e privo di alogeni. Superficie esterna liscia ed ancoraggio sulle spire. Protetti da una treccia metallica in acciaio inox AISI 304, per una elevata resistenza all'usura, all'abrasione ed allo scintillio. Resistenti ai più comuni oli e grassi, presentano buona flessibilità e resistenza meccanica. Protezione dalle interferenze elettromagnetiche su un'ampia banda di frequenze. Continuità elettrica garantita. Colore distintivo treccia verde

Pliable conduits in galvanized steel with Sendzimir method (UNI EN 10346). The coating is made of thermoplastic, halogen free, flame retardant EVA with a low level of toxic and corrosive gas emissions. Smooth external surface and thread fastening. They are protected by AISI 304 stainless steel braid which gives them a high resistance to wear and abrasion and to sparks. Resistant to most common oils and greases, they are extremely flexible and have excellent levels of mechanical resistance. They offer a good protection from electromagnetic interferences over a wide band of frequencies. Electrical continuity guaranteed. Distinctive braid colour green

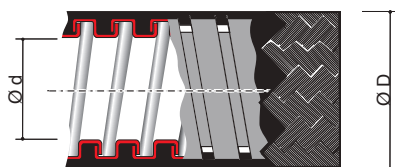

HF
Halogen
FREE

- Standard
**CEI EN 61386-1, CEI EN 61386-22,
UNI CEI EN 45545-2:2013**
- Classificazione CEI EN 61386 **3 4 4 1**
- Grado IP CEI EN 60529 **IP66/IP68/IP69**
- Resistenza alla compressione
DN10÷DN27 **1250N**
DN35÷DN51 **750 N**
- Resistenza all'urto **6 J**
- Resistenza alla trazione
DN10÷DN16 **500N**
DN21÷DN51 **1000 N**
- Resistenza al carico sospeso **450 N**
- Emissioni fumi secondo NF F 16-101 **F1**
- Schermatura EMC secondo
IEC TS 61587: 30-230MHz
Livello1 (Abbattimento min. 35dB)

- Standard
**IEC EN 61386-1 and 61386-22,
UNI IEC 45545-2:2013**
- Classificazione IEC EN 61386 **3 4 4 1**
- IP degree IEC EN 60529 **IP66/IP67/IP69**
- Compressive strength
DN10÷DN27 **1250N**
DN35÷DN51 **750 N**
- Impact resistance **6 J**
- Tensile strength
DN10÷DN16 **500N**
DN21÷DN51 **1000 N**
- Resistance to suspended load **450 N**
- Fume emission NF F 16-101 **F1**
- EMC Shielding according to
IEC TS 61587: 30-230MHz
Level 1 (Minimum abatement 35dB)

Aggraffatura semplice Simple interlocking



CODICE CODE	DIAMETRO NOMINALE NOMINAL DIAMETER	DIAMETRO INTERNO INTERNAL DIAMETER	DIAMETRO ESTERNO EXTERNAL DIAMETER	RAGGIO CURVA RADIUS CURVE	CONFEZIONE PACKAGE
		mm	mm		m
607ETX010*	10	10,0	17,0	60	50
607ETX012*	12	12,0	20,0	70	50
607ETX016*	16	15,5	23,0	90	50

* A richiesta / On request

Aggraffatura rinforzata Reinforced interlocking



CODICE CODE	DIAMETRO NOMINALE NOMINAL DIAMETER	DIAMETRO INTERNO INTERNAL DIAMETER	DIAMETRO ESTERNO EXTERNAL DIAMETER	RAGGIO CURVA RADIUS CURVE	CONFEZIONE PACKAGE
		mm	mm		m
607ETX022*	21	20,5	29,0	65	50
607ETX032*	27	26,5	35,0	80	25
607ETX038*	35	35,0	44,0	120	25
607ETX040*	40	40,0	49,0	150	25
607ETX050*	51	50,5	60,0	220	25

* A richiesta / On request

Accessori correlati Related accessories

6014	6014-G	6014XX	6014-P	6015	6115	6024	6025	6117	6117XX	Series Series T
pag. 56	pag. 58	pag. 61	pag. 63	pag. 60	pag. 64	pag. 65	pag. 84	pag. 87	pag. 68/69	

■ Guaina metallica Flexible conduit

In acciaio zincato **667M**
In galvanized steel **667M**



Tubi flessibili ricavati in nastro di acciaio zincato a caldo con metodo Sendzimir (UNI EN 10346).
Presentano ottima flessibilità e buona resistenza meccanica.
Continuità elettrica garantita

Flexible conduits made of strip of hot-dip galvanised steel with method Sendzimir (UNI EN 10346).
They are extremely flexible and have excellent mechanical resistance.
Electrical continuity guaranteed

E' necessario l'utilizzo dell'accessorio cod. 66BOTT boccola in ottone in sostituzione della boccola in nylon normalmente in dotazione nei raccordi.

It is necessary the use of the accessory code 66BOTT brass bushing to replace the nylon bushing normally supplied with the fittings.

- Standard CEI EN 61386-1 e 61386-23
- Classificazione CEI EN 61386 **3 3 5 6**
- Grado IP CEI EN 60529 **IP40**
- Resistenza alla compressione **750 N**
- Resistenza all'urto **2 J**
- Resistenza alla trazione **500 N**
- Resistenza al carico sospeso **450 N**
- Resistenza alla corrosione **2 Media**

- Standard IEC EN 61386-1 and 61386-23
- IP degree IEC EN 61386 **3 3 5 6**
- Protection degree CEI EN 60529 **IP40**
- Compressive strength **750 N**
- Impact resistance **2 J**
- Tensile strength **500 N**
- Resistance to suspended load **450 N**
- Corrosion resistance **2 Medium**

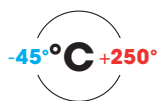
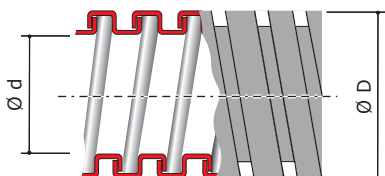

Aggraffatura semplice Simple interlocking



CODICE CODE	DIAMETRO NOMINALE NOMINAL DIAMETER	DIAMETRO INTERNO INTERNAL DIAMETER mm	DIAMETRO ESTERNO EXTERNAL DIAMETER mm	RAGGIO CURVA RADIUS CURVE	CONFEZIONE PACKAGE m
667M1013	10	10,0	13,0	30	50
667M1215	12	12,0	15,0	35	50
667M1518	16	15,5	18,5	40	50

Aggraffatura rinforzata Reinforced interlocking



CODICE CODE	DIAMETRO NOMINALE NOMINAL DIAMETER	DIAMETRO INTERNO INTERNAL DIAMETER mm	DIAMETRO ESTERNO EXTERNAL DIAMETER mm	RAGGIO CURVA RADIUS CURVE	CONFEZIONE PACKAGE m
667M2024	21	20,5	24,5	50	50
667M2630	27	26,5	30,0	70	25
667M3539	35	35,0	39,5	90	25
667M4044	40	40,0	44,5	105	25
667M5054	51	50,5	54,5	130	25

Accessori correlati Related accessories

Accessorio necessario
Necessary accessory



66BOTT

6014

6014-G

6014XX

6014-P

6015

6115

6024

6025

6117

6117XX

pag. 74

pag. 56

pag. 58

pag. 61

pag. 63

pag. 60

pag. 64

pag. 65

pag. 84

pag. 87

■ Guaina metallica Flexible conduit

A doppia aggraffatura **667DM** Double interlocking **667DM**

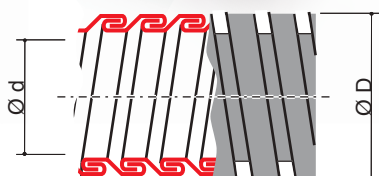

Tubi flessibili in acciaio zincato a caldo con metodo Sendzimir (UNI EN 10346) profilato a doppia aggraffatura.

Presentano buona flessibilità ed ottima resistenza meccanica, in modo particolare per le sollecitazioni a trazione, torsione ed urto. Continuità elettrica garantita

E' necessario l'utilizzo dell'accessorio cod. 66BOTT boccola in ottone in sostituzione della boccola in nylon normalmente in dotazione nei raccordi.

- Standard
CEI EN 61386-1, CEI EN 61386-23
- Classificazione CEI EN 61386 **4 4 5 6**
- Grado IP CEI EN 60529 **IP40**
- Resistenza alla compressione **1250 N**
- Resistenza all'urto **6 J**
- Resistenza alla trazione **1000 N**
- Resistenza al carico sospeso **450 N**
- Resistenza alla corrosione **2 Media**

Flexible conduits in hot galvanized steel with Sendzimir method (UNI EN 10346) double-interlocking profiled. They are extremely flexible and have an excellent mechanical resistance particularly when subjected to stress resulting from traction, torsion and impact.

Electrical continuity guaranteed

It is necessary the use of the accessory code 66BOTT brass bushing to replace the nylon bushing normally supplied with the fittings.

- Standard
IEC EN 61386-1 and 61386-23
- Classification CEI EN 61386 **4 4 5 6**
- IP degree IEC EN 60529 **IP40**
- Compressive strength **1250 N**
- Impact resistance **6 J**
- Tensile strength **1000 N**
- Resistance to suspended load **450 N**
- Corrosion resistance **2 Medium**

-45°C +250°C



Aggraffatura doppia Double interlocking



CODICE CODE	DIAMETRO NOMINALE NOMINAL DIAMETER	DIAMETRO INTERNO INTERNAL DIAMETER	DIAMETRO ESTERNO EXTERNAL DIAMETER	RAGGIO DI CURVA CURVE RADIUS	CONFEZIONE PACKAGE
		mm	mm		m
667DM10	10	10,0	13,0	50	50
667DM12	12	12,0	15,0	55	50
667DM15	16	15,5	18,5	60	50
667DM20	21	20,5	24,5	90	50
667DM26	27	26,5	30,0	110	25
667DM35	35	35,0	39,0	130	25
667DM40	40	40,0	44,0	160	25
667DM50	51	50,5	54,5	200	25
667DM63*	63	63,0	67,5	300	12
667DM75*	75	75,0	79,5	350	8
667DM100*	100	100,0	104,5	460	8

* A richiesta / On request

Accessori correlati Related accessories

Accessorio necessario
Necessary accessory



66BOTT

6014

6014-G

6014XX

6014-P

6015

6115

6024

6025

6117

6117XX

pag. 74

pag. 56

pag. 58

pag. 61

pag. 63

pag. 60

pag. 64

pag. 65

pag. 84

pag. 87

Guaina metallica Flexible conduit

A doppia aggraffatura in acciaio inox AISI 304 **667DXM** Double interlocking in AISI 304 stainless steel **667DXM**

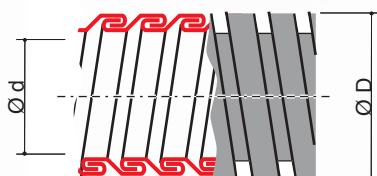

Tubi flessibili in nastro di acciaio inox AISI 304 (X5 CrNi1810 1.4301 UNI EN 10088-1) profilato a doppia aggraffatura. Presentano buona flessibilità ed ottima resistenza meccanica, in modo particolare per le sollecitazioni a trazione, torsione ed urto. Idonei per ambienti chimici aggressivi. Continuità elettrica garantita
E' necessario l'utilizzo dell'accessorio cod. 66BOTT boccola in ottone in sostituzione della boccola in nylon normalmente in dotazione nei raccordi.

Flexible conduits made of AISI 304 stainless steel strip (X5 CrNi1810 1.4301 UNI EN 10088-1) double-interlocking profiled. They are extremely flexible and have an excellent mechanical resistance particularly when subjected to stress resulting from traction, torsion and impact. Suitable for harsh chemical environments. Electrical continuity guaranteed
It is necessary the use of the accessory code 66BOTT brass bushing to replace the nylon bushing normally supplied with the fittings.

- Standard **CEI EN 61386-1 e 61386-23**
- Classificazione CEI EN 61386 **4 4 5 6**
- Grado IP CEI EN 60529 **IP40**
- Resistenza alla compressione **1250 N**
- Resistenza all'urto **6 J**
- Resistenza alla trazione **1000 N**
- Resistenza al carico sospeso **450 N**
- Resistenza alla corrosione **4 Alta**

- Standard **IEC EN 61386-1 and 61386-23**
- Classification IEC EN 61386 **4 4 5 6**
- IP degree IEC EN 60529 **IP40**
- Compressive strength **1250 N**
- Impact resistance **6 J**
- Tensile strength **1000 N**
- Resistance to suspended load **450 N**
- Corrosion resistance **4 High**

Aggraffatura doppia Double interlocking

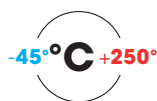

CODICE CODE	DIAMETRO NOMINALE NOMINAL DIAMETER	DIAMETRO INTERNO INTERNAL DIAMETER mm	DIAMETRO ESTERNO EXTERNAL DIAMETER mm	RAGGIO DI CURVA CURVE RADIUS mm	CONFEZIONE PACKAGE m
667DXM10*	10	10,0	13,0	50	50
667DXM12*	12	12,0	15,0	55	50
667DXM15*	16	15,5	18,5	60	50
667DXM20*	21	20,5	24,5	90	50
667DXM26*	27	26,5	30,0	110	25
667DXM35*	35	35,0	39,0	130	25
667DXM40*	40	40,0	44,0	160	25
667DXM50*	51	50,5	54,5	200	25

* A richiesta / On request

Accessori correlati Related accessories

Accessorio necessario
Necessary accessory



66BOTT

6014

6014-G

6014XX

6014-P

6015

6115

6024

6025

6117

6117XX

pag. 74

pag. 56

pag. 58

pag. 61

pag. 63

pag. 60

pag. 64

pag. 65

pag. 84

pag. 87

■ Guaina metallica Flexible conduit

A doppia aggraffatura in acciaio inox AISI 316L **667DXXM** Double interlocking in AISI 316L stainless steel **667DXXM**

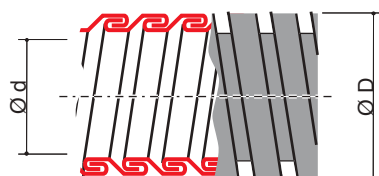

Tubi flessibili in nastro di acciaio inox AISI 316L profilato a doppia aggraffatura. Presentano buona flessibilità ed ottima resistenza meccanica, in modo particolare per le sollecitazioni a trazione, torsione ed urto. Idonei per ambienti chimici aggressivi. Continuità elettrica garantita

E' necessario l'utilizzo dell'accessorio cod. 66BOTT boccola in ottone in sostituzione della boccola in nylon normalmente in dotazione nei raccordi.

Double interlocking flexible conduits made of stainless steel AISI 316L. They are extremely flexible and have an excellent mechanical resistance particularly when subjected to stress resulting from traction, torsion and impact. Suitable for harsh chemical environments. Electrical continuity guaranteed
It is necessary the use of the accessory code 66BOTT brass bushing to replace the nylon bushing normally supplied with the fittings.

- Standard **CEI EN 61386-1 e 61386-23**
- Classificazione CEI EN 61386 **4 4 5 6**
- Grado IP CEI EN 60529 **IP40**
- Resistenza alla compressione **1250 N**
- Resistenza all'urto **6 J**
- Resistenza alla trazione **1000 N**
- Resistenza al carico sospeso **450 N**
- Resistenza alla corrosione **4 Alta**

- Standard **IEC EN 61386-1 and 61386-23**
- Classification IEC EN 61386 **4 4 5 6**
- IP degree IEC EN 60529 **IP40**
- Compressive strength **1250 N**
- Impact resistance **6 J**
- Tensile strength **1000 N**
- Resistance to suspended load **450 N**
- Corrosion resistance **4 High**

-45°C +250°C



Aggraffatura doppia Double interlocking



CODICE CODE	DIAMETRO NOMINALE NOMINAL DIAMETER	DIAMETRO INTERNO INTERNAL DIAMETER mm	DIAMETRO ESTERNO EXTERNAL DIAMETER mm	RAGGIO DI CURVA CURVE RADIUS mm	CONFEZIONE PACKAGE m
667DXXM10*	10	10,0	13,0	50	50
667DXXM12*	12	12,0	15,0	55	50
667DXXM15*	16	15,5	18,5	60	50
667DXXM20*	21	20,5	24,5	90	50
667DXXM26*	27	26,5	30,0	110	25
667DXXM35*	35	35,0	39,0	130	25
667DXXM40*	40	40,0	44,0	160	25
667DXXM50*	51	50,5	54,5	200	25

*A Richiesta / On Request

Accessori correlati Related accessories

Accessorio necessario
Necessary accessory



66BOTT

6014XX

6117XX

pag. 74

pag. 61

pag. 87

■ Guaina metallica Flexible conduit

Protetta con treccia in acciaio zincato 607T Protected with galvanised steel braided 607T



Tubi flessibili in acciaio zincato a caldo con metodo Sendzimir (UNI EN 10346). Sono ricoperti da una treccia in acciaio zincato. Presentano ottima flessibilità e buona resistenza meccanica, offrono una buona protezione dalle interferenze elettromagnetiche.

Sono impiegati per applicazioni industriali dove è necessaria un'alta resistenza termica, con raccordi TN il sistema è privo di materie plastiche.

Continuità elettrica garantita

Flexible conduits in hot galvanized steel with Sendzimir method (UNI EN 10346:2009).

The conduits are protected by galvanised steel braid. They provide excellent flexibility and good mechanical resistance together with good protection against electro-magnetic interference.

They are used in industrial applications where a high level of thermal resistance is required, with TN fittings the system is without any plastic materials.

Electrical continuity guaranteed

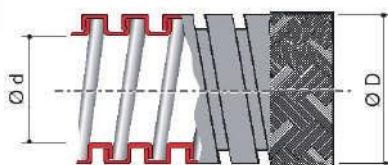

- Standard
CEI EN 61386-1 e CEI EN61386-23
- Classificazione CEI EN 61386 **3 3 5 6**
- Grado IP CEI EN 60529 **IP40**
- Resistenza alla compressione **750 N**
- Resistenza all'urto **2 J**
- Resistenza alla corrosione **2 Media**
- Schermatura EMC secondo IEC TS 61587: 30-230MHz
Livello1 (Abbattimento min. 35dB)

- Standard
IEC EN 61386-1 and 61386-23
- Classification °IEC EN 61386 **3 3 5 6**
- IP degree IEC EN 60529 **IP40**
- Compressive strength **750 N**
- Impact resistance **2 J**
- Corrosion resistance **2 Medium**
- EMC shielding in according to IEC TS 61587:30 - 230MHz
Level 1 (minimum abatement 35dB)

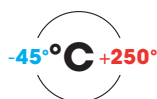

Aggraffatura semplice Simple interlocking



CODICE CODE	DIAMETRO NOMINALE NOMINAL DIAMETER	DIAMETRO INTERNO INTERNAL DIAMETER mm	DIAMETRO ESTERNO EXTERNAL DIAMETER mm	RAGGIO DI CURVA CURVE RADIUS	CONFEZIONE PACKAGE m
607T-10*	10	10,0	15,5	30	50
607T-12*	12	12,0	17,5	35	50
607T-16*	16	15,5	21,0	40	50

* A richiesta / On request

Aggraffatura rinforzata Reinforced interlocking



CODICE CODE	DIAMETRO NOMINALE NOMINAL DIAMETER	DIAMETRO INTERNO INTERNAL DIAMETER mm	DIAMETRO ESTERNO EXTERNAL DIAMETER mm	RAGGIO DI CURVA CURVE RADIUS	CONFEZIONE PACKAGE m
607T-20*	21	20,5	26,0	50	50
607T-27*	27	26,5	33,0	70	25
607T-35*	35	35,0	41,5	90	25
607T-40*	40	40,0	47,0	105	25
607T-50*	51	50,5	58,0	130	25

* A richiesta / On request

IEC TS 61587



Accessori correlati Related accessories

6014	6014-G	6014XX	6014-P	6015	6115	6024	6025	6117	6117XX	Series Series T
pag. 56	pag. 58	pag. 61	pag. 63	pag. 60	pag. 64	pag. 65	pag. 84	pag. 87	pag. 68/69	pag. 68/69

■ Tubo pieghevole Pliable conduit

A parete continua in acciaio inox AISI 321 607X Continuous in AISI 321 stainless steel 607X

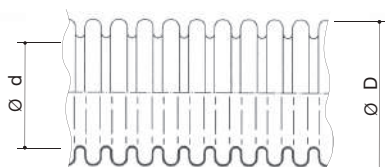

Tubi pieghevoli ondulati, prodotti in acciaio inox AISI 321 (X6CrNiTi 1811 1.4541 UNI EN10088-1) indicati in ambienti chimici aggressivi, dotati di buona flessibilità, possono essere utilizzati anche in particolari condizioni di difficile curvabilità dei tubi metallici rigidi.

Presentano un'elevata resistenza allo schiacciamento.

Superfici interne ed esterne entrambe ondulate, offrono un ottimo scorrimento dei cavi durante l'infilaggio.

Continuità elettrica garantita

AISI 321 (X6CrNiTi 1811 1.4541 UNI EN10088-1) corrugated pliable conduits, designed particularly for use in harsh chemical environments, with good flexibility, they can also be used under particular conditions of difficult pliability of rigid metal conduits.

High levels of resistance to crushing.

Internal and external surfaces corrugated to allows cables to slide through extremely easily during feeding.

Electrical continuity guaranteed

- **CEI EN 61386-1 e CEI EN 61386-22**
- Classificazione CEI EN 61386 **5 5 5 4**
- Grado IP CEI EN 60529 **IP67** con accessorio cod. 6060X
- Resistenza alla compressione **4000 N**
- Resistenza all'urto **20 J**
- Resistenza alla trazione **2500 N**
- Resistenza al carico sospeso **450 N**

- **Standard IEC EN 61386-1 and 61386-22**
- Classification IEC EN 61386 **5 5 5 4**
- IP degree IEC EN 60529 **IP67 with accessory cod. 6060X**
- Compressive strength **4000 N**
- Impact resistance **20 J**
- Tensile strength **2500 N**
- Resistance to suspended load **450 N**

CODICE CODE	DIAMETRO NOMINALE NOMINAL DIAMETER	DIAMETRO INTERNO INTERNAL DIAMETER ø d, mm	DIAMETRO ESTERNO EXTERNAL DIAMETER ø D, mm	RAGGIO DI CURVA CURVE RADIUS mm	CONFEZIONE PACKAGE m
607X-12	12	12,8	16,8	25	15
607X-16	16	16,7	22,2	30	15
607X-22	21	20,7	27,1	35	15
607X-32	27	25,6	33,2	40	15
607X-38	35	32,6	42,0	50	15

Accessori correlati Related accessories



6014

6014-G

6014XX

6014-P

6015

6115

6024

6025

6117

6117XX

pag. 56

pag. 58

pag. 61

pag. 63

pag. 60

pag. 64

pag. 65

pag. 84

pag. 87

■ Tubo pieghevole Pliable conduit

A parete continua in acciaio inox AISI 316L 607XX Continuous in AISI 316L stainless steel 607XX

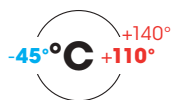
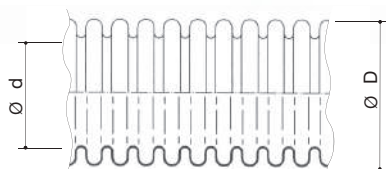

Tubi pieghevoli ondulati, prodotti in acciaio inox AISI 316L indicati in ambienti chimici aggressivi, dotati di buona flessibilità, possono essere utilizzati anche in particolari condizioni di difficile curvabilità dei tubi metallici rigidi.

Presentano un'elevata resistenza allo schiacciamento.

Superfici interne ed esterne entrambe ondulate, offrono un ottimo scorrimento dei cavi durante l'infilaggio.

Continuità elettrica garantita

- Standard
CEI EN 61386-1 e CEI EN 61386-22
- Classificazione CEI EN 61386 **5 5 5 4**
- Grado IP CEI EN 60529 **IP67**
con accessorio cod. 6060X
- Resistenza alla compressione **4000 N**
- Resistenza all'urto **20 J**
- Resistenza alla trazione **2500 N**
- Resistenza al carico sospeso **450 N**

AISI 316L (X2CrNiMo17-12-2 1.4404 UNI EN10088-1) corrugated pliable conduits, designed particularly for use in harsh chemical environments, with good flexibility, they can also be used under particular conditions of difficult pliability of rigid metal conduits.

High levels of resistance to crushing.

Internal and external surfaces corrugated to allows cables to slide through extremely easily during feeding.

Electrical continuity guaranteed

- Standard
IEC EN 61386-1 and 61386-22
- Classification IEC EN 61386 **5 5 5 4**
- IP degree IEC EN 60529
IP67 with accessory cod. 6060X
- Compressive strength **4000 N**
- Impact resistance **20 J**
- Tensile strength **2500 N**
- Resistance to suspended load **450 N**

CODICE CODE AISI 316L	DIAMETRO NOMINALE NOMINAL DIAMETER	DIAMETRO INTERNO INTERNAL DIAMETER ø d, mm	DIAMETRO ESTERNO EXTERNAL DIAMETER ø D, mm	RAGGIO CURVA RADIUS CURVE mm	CONFEZIONE PACKAGE m
607XX-12*	12	12,8	16,8	25	15
607XX-16*	16	16,7	22,2	30	15
607XX-22*	21	20,7	27,1	35	15
607XX-32*	27	25,6	33,2	40	15
607XX-38*	35	32,6	42,0	50	15

* A richiesta / On request

Kit per tubi pieghevoli in acciaio inox 6060X Kit for flexible stainless steel conduits 6060X



Costituito da due semigusci cilindrici in ottone nichelato, sagomati al fine di inserirsi nell'ondulazione del tubo ed impedirne lo scorrimento assiale e da una guarnizione piana che ne assicura la tenuta stagna. Il kit può essere montato su qualsiasi raccordo per tubi metallici pieghevoli, in sostituzione della boccola e della virola normalmente in dotazione.

Per tubi codice 607X e 607XX.

The kit consists of two nickel plated brass cylindrical half-shells appropriately shaped in order to be inserted into the corrugation of the conduit and prevent it from sliding, and by a flat seal which ensures its water tightness. The kit can be fitted onto any type of fitting for metal flexible conduits, to replace the bushing and the base normally supplied as standard.

For conduit code 607X and 607XX.

CODICE CODE	DIAMETRO NOMINALE NOMINAL DIAMETER mm	DIAMETRO TUBO CONDUIT DIAMETER d, mm	CONFEZIONE PACKAGE m
6060X-12	12	12,8	20
6060X-16	16	16,7	20
6060X-22	21	20,7	20
6060X-32	27	25,6	20
6060X-38	35	32,6	20

Accessori correlati Related accessories

6014	6014-G	6014XX	6014-P	6015	6115	6024	6025	6117	6117XX
pag. 56	pag. 58	pag. 61	pag. 63	pag. 60	pag. 64	pag. 65	pag. 84	pag. 87	

■ Calza Sleeve

In fibra di vetro ricoperta in silicone **60HT** Glass fibre coated in silicone **60HT**



Calze treciate realizzate con fili di fibra di vetro "E", ricoperti da silicone rosso non propagante la fiamma (spessore 1mm). In funzione della loro costruzione con processo unico, risultano estremamente flessibili e si conformano facilmente a forme e profili, adattandosi a tubi e cavi in modo aderente. Trovano una pronta applicazione come isolamento e/o protezione dei cavi in varie applicazioni industriali dove è richiesta una barriera protettiva per l'alta temperatura.

- Standard **UL 1441 VW-I**
- Grado IP CEI EN 60529 **IP66 / IP68**
- Esposizione oltre i 1090° C
15-20 minuti
- Esposizione oltre i 1650° C
15-30 secondi

Silicone sleeves made of "E" fibre glass yarn coated in flame retardant red silicone (1mm thickness).

Since they are manufactured with single process, they are extremely flexible, easily adaptable to shapes and profiles, close-fittingly adapting themselves to conduits and cables.

They find ready application as insulation and/or protection of cables in a variety of industries where a barrier for high temperatures might be required.

- Standard **UL 1441 VW-I**
- IP degree IEC EN 60529 **IP66 / IP68**
- Exposure over 1090° C
15-20 minutes
- Exposure over 1650° C
15-30 seconds

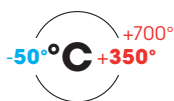

CODICE CODE	DIAMETRO INTERNO INTERNAL DIAMETER mm	CONFEZIONE PACKAGE m
60HT-10	10	20
60HT-12	12	20
60HT-15	15	20
60HT-20	20	20
60HT-25	25	20
60HT-30	30	20
60HT-35	35	20
60HT-38	38	20
60HT-40	40	20
60HT-42	42,5	20
60HT-45	45	15
60HT-51	51	15
60HT-60	60	15
60HT-65	65	15
60HT-70	70	15
60HT-75	75	15
60HT-80	80	15
60HT-85	85	15
60HT-90	90	15
60HT-100	100	15
60HT-115	115	10

■ Guaina Flexible conduit

In PVC liscio **6085**

In smooth PVC **6085**

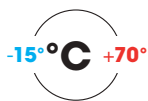
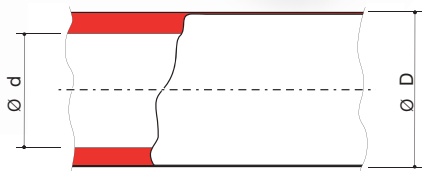

Tubi flessibili prodotti in PVC non propagante la fiamma, offrono ottima resistenza ai più comuni oli, grassi ed acidi diluiti, presentano buona resistenza all'invecchiamento. Superfici interne ed esterne lisce. Grigio scuro e blu a richiesta

PVC flame retardant flexible conduits, resistant to most oils, greases and diluted acids and in particular to ageing. Smooth internal and external surfaces. Dark Grey and Blue on request

- Standard
CEI EN 61386-1, CEI EN 61386-23
- Classificazione CEI EN 61386 **0 2 3 1**
- Grado IP CEI EN 60529 **IP65 / IP67**
- Resistenza all'urto **1 J**

- Standard
IEC EN 61386-1 and 61386-23
- Classification IEC EN 61386 **0 2 3 1**
- IP degree IEC EN 60529 **IP65 / IP67**
- Impact resistance **1 J**

CODICE GRIGIO CODE GRAY	CODICE BLU BLUE CODE	DIAMETRO NOMINALE NOMINAL DIAMETER	DIAMETRO INTERNO INTERNAL DIAMETER ød, mm	DIAMETRO ESTERNO EXTERNAL DIAMETER øD, mm	CONFEZIONE PACKAGE m
6085-10	6085-10A*	10	10	14	50
6085-12	6085-12A*	12	12	16	50
6085-15	6085-15A*	16	15	20	50
6085-20	6085-20A*	20	20	26	50
6085-27	6085-27A*	27	27	34	25
6085-36	6085-36A*	35	36	43	25
6085-40	6085-40A*	40	40	48	25

*A Richiesta / On Request

Accessori correlati Related accessories



6057

pag. 72



6188

pag. 70



6059

pag. 73

■ Guaina Flexible conduit

In PVC liscio protetta con treccia metallica **6089**

In smooth PVC protected with metal braid **6089**

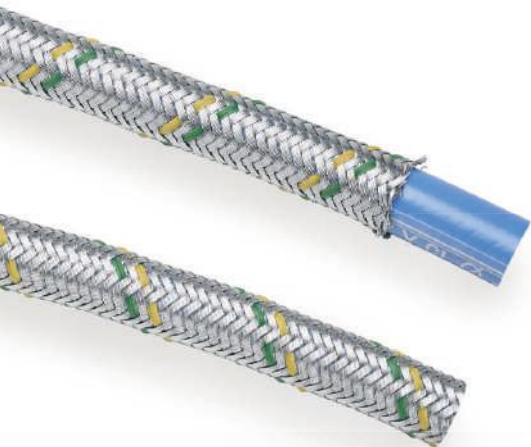

Tubi flessibili in PVC non propagante la fiamma, offrono un'ottima resistenza ai più comuni oli, grassi ed acidi diluiti, presentano buona resistenza all'invecchiamento. Sono protetti con trecciatura in fili di acciaio che ne conferisce una elevata resistenza all'usura.

Trecciatura standard
Colore distintivo treccia giallo/verde

- Standard
CEI EN 61386-1, CEI EN 61386-23
- Classificazione CEI EN 61386 **0 2 3 1**
- Grado IP **IP67** secondo CEI EN 60529 (IEC 529 Standard)
- Resistenza all'urto **1 J**

PVC flame retardant flexible conduits, resistant to most oils, greases and diluted acids and in particular to ageing. Protected with a steel wire braid which offers high levels of protection against wear.

Standard braiding
Distinctive braid colour yellow/green

- Standard
IEC EN 61386-1 and 61386-23
- Classification IEC EN 61386 **0 2 3 1**
- IP degree **IP67** according to IEC EN 60529 (IEC 529 Standard)
- Impact resistance **1 J**

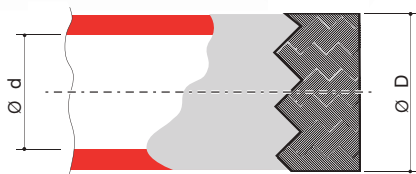

CODICE CODE	DIAMETRO NOMINALE NOMINAL DIAMETER	DIAMETRO INTERNO INTERNAL DIAMETER mm	DIAMETRO ESTERNO EXTERNAL DIAMETER mm	RAGGIO CURVA RADIUS CURVE mm	CONFEZIONE PACKAGE m
6089-10	10	10	15,5	25	50
6089-12	12	12	17,5	30	50
6089-15	16	15	21,5	40	50
6089-20	20	20	26,5	50	50
6089-28	27	27	35,0	70	25
6089-35	35	36	45,0	110	25
6089-40	40	40	50,0	130	25

Accessori correlati Related accessories



6057	6059	6059T	6058
pag. 72	pag. 73	pag. 73	pag. 75

■ Guaina Flexible conduit

In PVC spiralato **6080**

In Helical PVC **6080**



Tubi flessibili prodotti in PVC plastificato non propagante la fiamma, rinforzato con spirale in PVC rigido antiurto.
Resistenti ai più comuni oli, grassi ed acidi diluiti, presentano buona resistenza all'invecchiamento.
Superfici interne lisce ed esterne ondulate.
Grigio RAL 7035 e Nero a richiesta

PVC plasticized flexible conduits, reinforced with rigid, impact-resistant helical PVC.
Resistant to most oils, greases and diluted acids and in particular to ageing.
Internal surfaces smooth and external surfaces corrugated.
Grey RAL 7035 and Black on request

- Standard
CEI EN 61386-1, CEI EN 61386-23
- Classificazione CEI EN 61386 **1 3 1 1**
- Grado IP CEI EN 60529 **IP65**
- Resistenza alla compressione **120 N**
- Resistenza all'urto **2 J**

- Standard
IEC EN 61386-1 and IEC EN 61386-23
- Classificazione IEC EN 61386 **1 3 1 1**
- IP degree IEC EN 60529 **IP65**
- Compressive strength **120 N**
- Impact resistance **2 J**

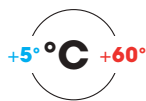
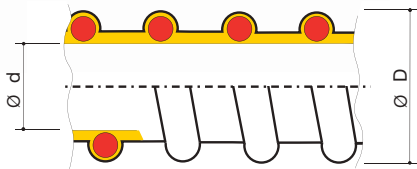

CODICE GRIGIO CODE GRAY RAL 7035	CODICE NERO CODE BLACK a rich./on req.	DIAMETRO NOMINALE NOMINAL DIAMETER	DIAMETRO INTERNO INTERNAL DIAMETER mm	DIAMETRO ESTERNO EXTERNAL DIAMETER mm	RAGGIO CURVA RADIUS CURVE mm	CONFEZIONE PACKAGE m
6080-10B	6080-10N*	10	10	14,7	30	30
6080-12B	6080-12N*	12	12	16,4	35	30
6080-16B	6080-16N*	16	16	20,7	45	30
6080-20B	6080-20N*	20	20	24,7	60	30
6080-25B	6080-25N*	25	25	30,6	70	30
6080-32B	6080-32N*	32	32	38,0	90	30
6080-40B	6080-40N*	40	40	46,4	110	30
6080-50B	6080-50N*	50	50	57,2	130	30

*A Richiesta / On Request

Accessori correlati Related accessories



6188

pag. 70

■ Guaina Flexible conduit

In PVC spiralato pesante (V0 UL94) 6079

Heavy helical PVC (V0 UL94) 6079

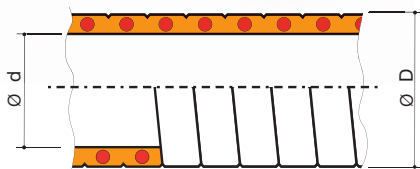

Tubi flessibili prodotti in PVC plastificato ad alto spessore non propaganti la fiamma, rinforzati con spirale in PVC rigido antiurto. Resistenti ai più comuni oli, grassi ed acidi diluiti, presentano buona resistenza meccanica ed all'invecchiamento. Superfici interne ed esterne lisce.

Colore Grigio RAL 7001

- Standard
CEI EN 61386-1, CEI EN 61386-23
- Classificazione CEI EN 61386 **2 3 1 1**
- Grado IP CEI EN 60529 **IP65**
- Resistenza alla compressione **320 N**
- Resistenza all'urto **2 J**
- Autoestinguenza UL94 **V0**

Extra thick, plasticized PVC flexible conduits, reinforced with rigid, fire retardant and impact-resistant helical PVC.

Resistant to most oils, greases and diluted acids and in particular to ageing. Smooth internal and external surfaces.

Colour Grey RAL 7011

- Standard
IEC EN 61386-1 and IEC EN 61386-23
- Classification IEC EN 61386 **2 3 1 1**
- IP degree IEC EN 60529 **IP65**
- Compressive strength **320 N**
- Impact resistance **2 J**
- Self-extinguishing UL94 **V0**

CODICE GRIGIO CODE GRAY	DIAMETRO NOMINALE NOMINAL DIAMETER	DIAMETRO INTERNO INTERNAL DIAMETER mm	DIAMETRO ESTERNO EXTERNAL DIAMETER mm	RAGGIO CURVA RADIUS CURVE	CONFEZIONE PACKAGE m
6079-10B	10	10	14,0	40	30
6079-12B	12	12	16,4	55	30
6079-16B	16	16	20,7	70	30
6079-20B	20	20	24,7	80	30
6079-28B	27	28	33,5	90	30
6079-35B	35	35	41,0	120	30
6079-40B	40	40	46,4	140	30
6079-50B	50	50	57,2	160	30

Accessori correlati Related accessories



6188

pag. 70



■ Caratteristiche raccordi per tubi metallici flessibili e pieghevoli

Characteristics fittings for flexible metal conduits



Il collegamento raccordo-tubo flessibile avviene mediante una virola che si avvita all'interno del tubo garantendo una elevata resistenza alla trazione e la continuità elettrica prevista dalle norme CEI. Una boccola in nylon di forma troncoconica assicura il bloccaggio esterno del tubo flessibile garantendo una tenuta stagna IP66/IP68/IP69.

La particolare cura nell'esecuzione di questi raccordi assicura un perfetto infilaggio dei cavi senza rischio di danneggiamento del rivestimento.

Continuità elettrica garantita

Materiale

- Ottone nichelato
- Acciaio inox AISI 316L

Versione

- Maschio fisso
- Maschio girevole
- Femmina fissa

Filettature

- Metrico ISO CEI EN 60423 (IEC60423),
- GAS cilindrico UNI ISO 228,
- GAS conico ISO 7/1 (ex UNI339),
- PG secondo DIN 40430
- NPT ANSI B2.1.

■ Standard

- **CEI EN 61386**
- Grado IP CEI EN 60529 **IP66/IP68/IP69** (per raccordi con filetto >2" **IP65**)
- Resistenza alla trazione **1000 N**
- Resistenza al carico sospeso **450 N**
- Resistenza alla corrosione
2 Media ottone - 4 Alta acciaio inox
- Resistenza alla corrosione
ISO 9227 **720 ore (Ottone nichelato)**

The connection fitting-flexible conduit is made employing a base that is screwed into the conduit to ensure high resistance tensile strength and electrical continuity as required by IEC standards. The external locking of the flexible conduit is ensured by a nylon truncated conical shaped bushing that guarantees an IP66/IP68/IP69 rating water tightness.

The special care in the production of these connectors ensures a perfect fitting of cables without risk of damaging the coating.

Electrical continuity guaranteed

Material

- Nickel plated brass
- Stainless steel AISI 316L

Version

- Fixed male
- Swivel male
- Fixed female

Threads

- ISO Metric IEC EN 60423 (IEC60423),
- UNI ISO 228 GAS cylindrical,
- Conical GAS ISO 7/1 (ex UNI339),
- PG in accordance with DIN 40430
- NPT ANSI B2.1.

■ Standard

- **IEC EN 61386**
- IP degree IEC EN 60529 **IP66/IP68/IP69** (for fittings with threads >2" **IP65**)
- Tensile strength **1000 N**
- Resistance to suspended load **450 N**
- Corrosion resistance
2 Medium brass - 4 High stainless steel
- Corrosion resistance
ISO 9227 **720 hours (Nickel plated brass)**

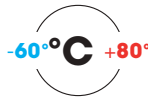

CEI EN 61386



CEI EN 61386



■ Caratteristiche raccordi per tubi metallici flessibili e pieghevoli Characteristics fittings for flexible metal conduits

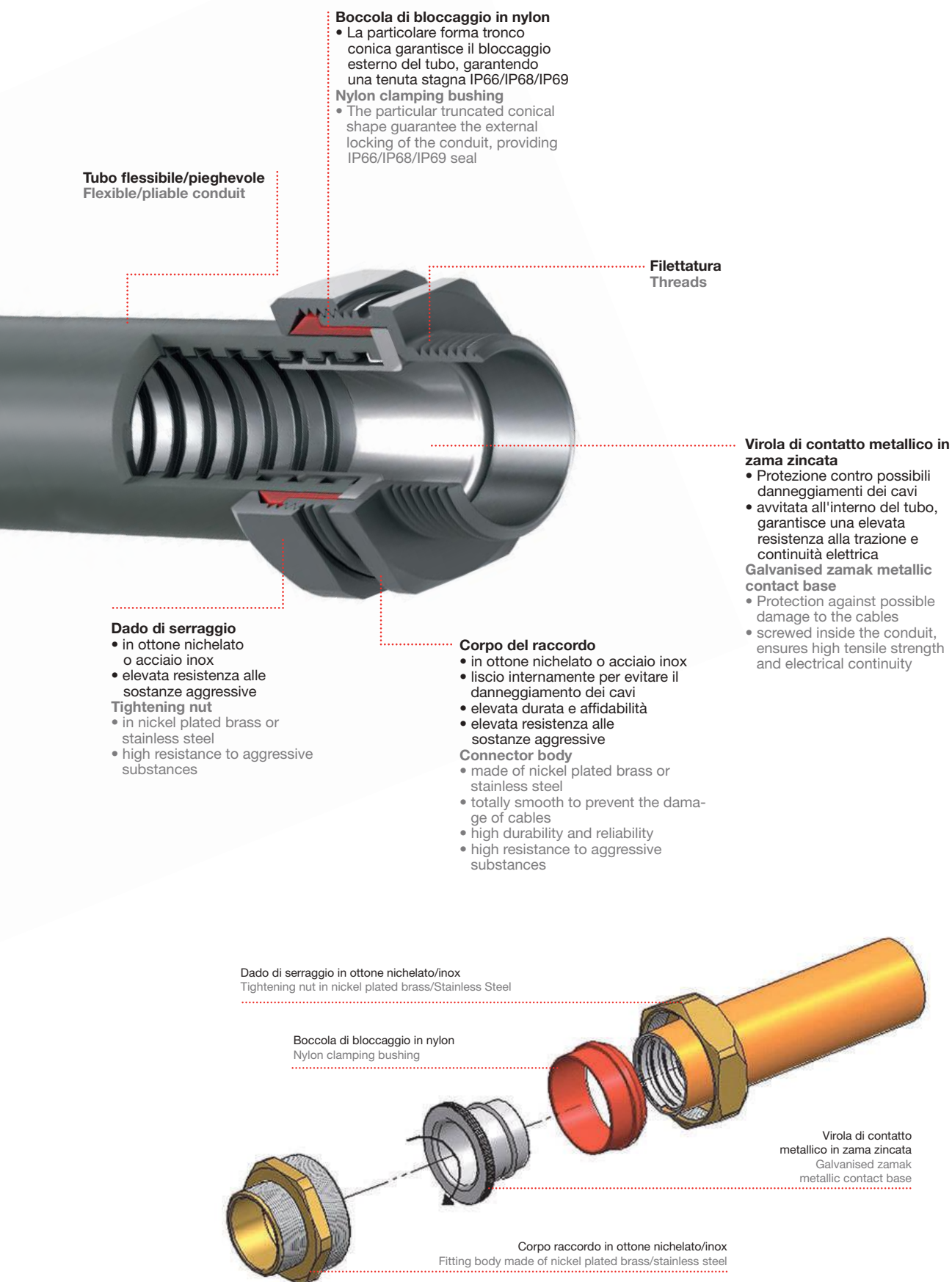

Raccordi metallici Metal fittings

Maschio fisso in ottone nichelato 6014 Fixed male in nickel plated brass 6014



Raccordo maschio fisso in ottone nichelato
adatto per tubi metallici flessibili e pieghe-
voli

Fixed male fitting in nickel-plated brass
suitable for flexible and foldable metal
pipes

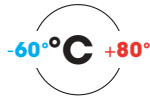
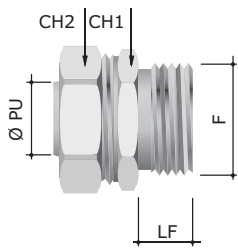

IP66
IP68
IP69

Filettatura metrica Metric thread

CODICE CODE	DIAMETRO NOMINALE NOMINAL DIAMETER Ød mm	F	DIMENSIONI mm DIMENSIONS mm			LF	CONFEZIONE PACKAGE pz / pcs.
			ØPU	CH1	CH2		
6014-1016	10	M16 x 1,5	8,5	22	24	10	20
6014-16A	12	M16 x 1,5	10,0	24	26	10	50
6014-1616	16	M16 x 1,5	12,0	28	30	10	40
6014-20A	16	M20 x 1,5	13,8	28	30	10	40
6014-2020	21	M20 x 1,5	16,0	35	37	10	20
6014-25A	21	M25 x 1,5	18,0	35	37	12	20
6014-2527	27	M25 x 1,5	20,0	42	45	12	15
6014-32A	27	M32 x 1,5	24,0	42	45	13	15
6014-40A	40	M40 x 1,5	34,0	58	61	18	5
6014-4035	35	M40 x 1,5	32,0	50	52	10	5
6014-50A	51	M50 x 1,5	44,0	70	74	18	5
6014-5040	40	M50 x 1,5	38,0	58	61	18	5
6014-6350	51	M63 x 1,5	48,0	70	74	18	1

Filettatura PG PG thread

CODICE CODE	DIAMETRO NOMINALE NOMINAL DIAMETER Ød mm	F	DIMENSIONI mm DIMENSIONS mm			LF	CONFEZIONE PACKAGE pz / pcs.
			ØPU	CH1	CH2		
6014-07	10	07	8,5	22	24	9	50
6014-1009	10	09	8,5	22	24	9	10
6014-1011	10	11	8,5	22	24	9	10
6014-1013	10	13	8,5	22	24	9	10
6014-09	12	09	10	24	26	9	10
6014-11	12	11	10	24	26	9	10
6014-1213	12	13,5	10	24	26	9	50
6014-1215	12	16	10	24	26	9	10
6014-13	16	13,5	13,8	28	30	10	50
6014-15	16	16	13,8	28	30	9	50
6014-1520*	21	16	16	35	37	9	10
6014-21	21	21	18	35	37	9	20
6014-29	27	29	24	42	45	12	15
6014-36	35	36	32	50	52	12	10
6014-42	40	42	38	58	61	18	5
6014-48	51	48	48	70	74	18	5

*A Richiesta / On Request

Filettatura metrica Metric thread

CEI EN 61386



CEI EN 61386



Raccordi metallici Metal fittings

Maschio fisso in ottone nichelato **6014** Fixed male in nickel plated brass **6014**

Filettatura GAS ISO 228 GAS ISO 228 thread

CODICE CODE	DIAMETRO NOMINALE NOMINAL DIAMETER Ød mm	F	DIMENSIONI mm DIMENSIONS mm			LF	CONFEZIONE PACKAGE pz / pcs.
			ØPU	CH1	CH2		
6014-10	10	1/4"	8,5	22	24	8,5	50
6014-1038	10	3/8"	8,5	22	24	8,5	10
6014-12	12	3/8"	10	24	26	8,5	50
6014-1212	12	1/2"	10	24	26	8,5	50
6014-16	16	1/2"	13,8	28	30	10	50
6014-22	21	3/4"	18	35	37	12	20
6014-32	27	1"	24	42	45	13	15
6014-38	35	1" 1/4	32	50	52	14	10
6014-381*	35	1" 1/2	32	50	52	10	10
6014-40	40	1" 1/2	38	58	61	18	5
6014-50	51	2"	48	70	74	18	5
6014-65	63	2" 1/2	59,5	94	94	26	1
6014-75	75	3"	71	104	104	25	1
6014-100	100	4"	95	129	129	30	1

*A Richiesta / On Request

Filettatura NPT NPT thread

CODICE CODE	DIAMETRO NOMINALE NOMINAL DIAMETER Ød mm	F	DIMENSIONI mm DIMENSIONS mm			LF	CONFEZIONE PACKAGE pz / pcs.
			ØPU	CH1	CH2		
6014-16NPT	16	1/2"	13,8	28	30	13,5	50
6014-22NPT	21	3/4"	18	35	37	14,5	20
6014-32NPT	27	1"	24	42	45	19	15
6014-38NPT*	35	1" 1/4	32	50	52	19	10
6014-40NPT*	40	1" 1/2	38	58	61	20,5	5
6014-50NPT*	51	2"	48	70	74	22	5
6014-65NPT*	63	2" 1/2	59,5	94	94	26	1
6014-75NPT*	75	3"	71	104	104	25	1
6014-100NPT*	100	4"	95	129	129	30	1

*A Richiesta / On Request

Filettatura Gas conico ISO 7/1 ISO 7/1 GAS Tapered thread

CODICE CODE	DIAMETRO NOMINALE NOMINAL DIAMETER Ød mm	F	DIMENSIONI mm DIMENSIONS mm			LF	CONFEZIONE PACKAGE pz / pcs.
			ØPU	CH1	CH2		
6014-1617	16	1/2"	13,8	28	30	13,5	30
6014-2217	21	3/4"	18	35	37	14,5	20
6014-3217	27	1"	24	42	45	19	15
6014-3817*	35	1" 1/4	32	50	52	20,5	10
6014-4017	40	1" 1/2	38	58	61	20,5	5
6014-5017	51	2"	48	70	74	22	5
6014-6517*	63	2" 1/2	59,5	94	94	26	1
6014-7517*	75	3"	71	104	104	25	1
6014-10017*	100	4"	95	129	129	30	1

*A Richiesta / On Request

Raccordi metallici Metal fittings

Maschio girevole in ottone nichelato 6014-G Swivel male in nickel plated brass 6014-G



Raccordo maschio fisso in ottone nichelato adatto per tubi metallici flessibili e pieghevoli
Elemento girevole protetto da guarnizione O-ring interna al raccordo.

Fixed male fitting in nickel-plated brass suitable for flexible and foldable metal pipes

Swivel element protected by an O-ring inside the fitting.

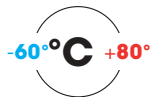
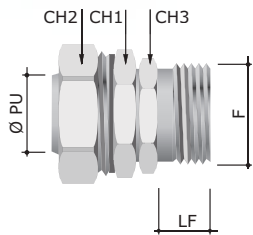

IP66
IP68
IP69

Filettatura metrica Metric thread

CODICE CODE	DIAMETRO NOMINALE NOMINAL DIAMETER		ØPU	DIMENSIONI mm DIMENSIONS mm			LF	CONFEZIONE PACKAGE pz / pcs.
	Ød mm	F		CH1	CH2	CH3		
6014-1016G	10	M16x1,5	8,5	22	24	20	10	30
6014-1216G	12	M16x1,5	10,0	24	26	22	10	30
6014-20G	16	M20x1,5	13,8	28	30	26	10	10
6014-25G	21	M25x1,5	18,0	35	37	32	10	20
6014-2732G	27	M32x1,5	24,0	42	45	39	13	10
6014-4035G	35	M40x1,5	32,0	50	52	50	14	7
6014-5040G	40	M50x1,5	38,0	58	61	55	18	5
6014-6350G	51	M63x1,5	48,0	70	74	70	18	1

Filettatura metrica Metric thread

CEI EN 61386	
CEI EN 61386	

Filettatura PG PG thread

CODICE CODE	DIAMETRO NOMINALE NOMINAL DIAMETER		ØPU	DIMENSIONI mm DIMENSIONS mm			LF	CONFEZIONE PACKAGE pz / pcs.
	Ød mm	F		CH1	CH2	CH3		
6014-09G	12	09	10	24	26	22	10	30
6014-1009G*	10	09	8,5	22	24	20	9	30
6014-11G	12	11	10	24	26	22	10	30
6014-1213G	12	13,5	10	24	26	22	10	30
6014-13G	16	13,5	13,8	28	30	26	10	30
6014-15G	16	16	13,8	28	30	26	10	30
6014-21G	21	21	18	35	37	32	13	20
6014-29G	27	29	24	42	45	40	13	10
6014-36G	35	36	32	50	52	50	14	7
6014-42G	40	42	38	58	61	55	18	5
6014-48G	51	48	48	70	74	70	18	5

*A Richiesta / On Request

Raccordi metallici Metal fittings

Maschio girevole in ottone nichelato **6014-G** Swivel male in nickel plated brass **6014-G**

Filettatura Gas ISO 228 Gas ISO 228 thread

CODICE CODE	DIAMETRO NOMINALE NOMINAL DIAMETER		F	ØPU	DIMENSIONI mm DIMENSIONS mm			LF	CONFEZIONE PACKAGE pz / pcs.
	Ød mm				CH1	CH2	CH3		
6014-10G*	10		1/4"	8,5	22	24	20	9	30
6014-1038G	10		3/8"	8,5	22	24	20	9	30
6014-12G	12		3/8"	10	24	26	22	10	30
6014-1212G	12		1/2"	10	24	26	22	10	50
6014-16G	16		1/2"	13,8	28	30	26	10	30
6014-22G	21		3/4"	18	35	37	32	10	20
6014-32G	27		1"	24	42	45	39	13	15
6014-38G	35		1" 1/4	32	50	52	50	14	7
6014-40G	40		1" 1/2	38	58	61	55	18	5
6014-50G	51		2"	48	70	74	70	18	5
6014-65G	63		2" 1/2	59,5	94	94	86	25	1
6014-75G	75		3"	71	104	104	96	25	1
6014-100G	100		4"	95	129	129	121	28	1

*A Richiesta / On Request

Filettatura NPT NPT thread

CODICE CODE	DIAMETRO NOMINALE NOMINAL DIAMETER		F	ØPU	DIMENSIONI mm DIMENSIONS mm			LF	CONFEZIONE PACKAGE pz / pcs.
	Ød mm				CH1	CH2	CH3		
6014-16NG	16		1/2"	13,8	28	30	26	13,5	30
6014-22NG	21		3/4"	18	35	37	32	14,5	20
6014-32NG	27		1"	24	42	45	39	19	10
6014-38NG*	35		1" 1/4	32	50	52	50	20,5	5
6014-40NG*	40		1" 1/2	38	58	61	55	20,5	5
6014-50NG*	51		2"	48	70	74	70	22	1
6014-65NG*	63		2" 1/2	59,5	94	94	86	25	1
6014-75NG*	75		3"	71	104	104	96	25	1
6014-100NG*	100		4"	95	129	129	121	28	1

*A Richiesta / On Request

Filettatura Gas conico ISO 7/1 ISO 7/1 GAS Tapered thread

CODICE CODE	DIAMETRO NOMINALE NOMINAL DIAMETER		F	ØPU	DIMENSIONI mm DIMENSIONS mm			LF	CONFEZIONE PACKAGE pz / pcs.
	Ød mm				CH1	CH2	CH3		
6014-16IG	16		1/2"	13,8	28	30	26	13,5	30
6014-22IG	21		3/4"	18	35	37	32	14,5	20
6014-32IG	27		1"	24	42	45	39	19	10
6014-38IG*	35		1" 1/4	32	50	52	50	20,5	5
6014-40IG*	40		1" 1/2	38	58	61	55	20,5	5
6014-50IG*	51		2"	48	70	74	70	22	1
6014-65IG*	63		2" 1/2	59,5	94	94	86	25	1
6014-75IG*	75		3"	71	104	104	96	25	1
6014-100IG*	100		4"	95	129	129	121	28	1

*A Richiesta / On Request

Raccordi metallici Metal fittings

Femmina in ottone nichelato 6015 - 6115 Female in nickel plated brass 6015 - 6115



Raccordi di giunzione necessari a collegare i tubi metallici rigidi filettabili cod 6008-P ai tubi metallici flessibili e pieghevoli.

Connection fittings needed to couple rigid metal threadable conduits, code 6008-P, to metal flexible and bendable conduits.

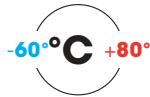
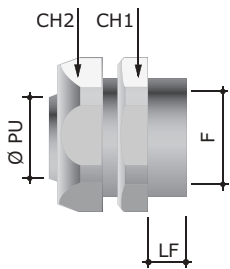

IP66
IP68
IP69

Filettatura Metrico Metric thread

CODICE CODE	DIAMETRO NOMINALE NOMINAL DIAMETER	F	DIMENSIONI mm DIMENSIONS mm			LF	CONFEZIONE PACKAGE pz / pcs.
	Ød mm		ØPU	CH1	CH2		
6015-10A	10	M16 x 1,5	8,5	22	24	12	20
6015-12A	12	M16 x 1,5	10,0	24	26	13	10
6015-16A	16	M16 x 1,5	13,8	28	30	14,5	50
6015-20	16	M20 x 1,5	13,8	28	30	14,5	50
6015-2020	21	M20 x 1,5	18,0	35	37	14	20
6015-25	21	M25 x 1,5	18,0	35	37	16	20
6015-2527	27	M25 x 1,5	23,0	42	45	16	15
6015-32A	27	M32 x 1,5	24,0	42	45	16	15
6015-3235	35	M32 x 1,5	30,0	50	52	17	10
6015-4035	35	M40 x 1,5	32,0	50	52	17	15
6015-40	40	M40 x 1,5	38,0	58	61	20	5
6015-5040	40	M50 x 1,5	38,0	58	61	23	5
6015-50	51	M50 x 1,5	48,0	70	74	20,5	5
6015-6350	51	M63 x 1,5	48,0	70	74	45	1

Filettatura metrica Metric thread

CEI EN 61386	
CEI EN 61386	

Filettatura Gas ISO 228 Gas ISO 228 thread

CODICE CODE	DIAMETRO NOMINALE NOMINAL DIAMETER	F	DIMENSIONI mm DIMENSIONS mm			LF	CONFEZIONE PACKAGE pz / pcs.
	Ød mm		ØPU	CH1	CH2		
6015-10	10	3/8"	8,5	22	24	11	50
6015-12	12	3/8"	10	24	26	11	10
6015-16	16	3/8"	13,8	28	30	13	50
6115-12	16	1/2"	13,8	28	30	14,5	50
6115-34	21	3/4"	18	35	37	13	20
6115-01	27	1"	24	42	45	14	15
6115-114	35	1" 1/4	32	50	52	13	10
6115-112	40	1" 1/2	38	58	61	20	5
6115-02	51	2"	48	70	74	20	1
6115-212	63	2" 1/2	59,5	94	94	26	1
6115-03	75	3"	71	104	104	28	1
6115-04	100	4"	95	129	129	30	1

Raccordi metallici Metal fittings

Maschio fisso in acciaio inox AISI 316L **6014XX** Fixed male in stainless steel AISI 316L **6014XX**



Sono prodotti in acciaio inox AISI 316L (X2CrNiMo17-12-2 1.4404 UNI EN10088-1), per essere utilizzati nei luoghi in cui i raccordi tradizionali in ottone nichelato non sono ritenuti sufficientemente resistenti alle condizioni ambientali.

Le caratteristiche di funzionamento sono identiche a quelle dei raccordi in ottone nichelato Cod. 6014.

Made in AISI 316L stainless steel (X2CrNiMo17-12-2 1.4404 UNI EN10088-1), to be used in situations where traditional nickel plated brass fittings are considered to be insufficiently resistant to the environmental conditions.

The operating characteristics are identical to those of the nickel-plated brass fittings code 6014.

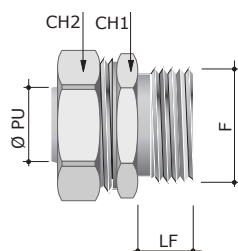

- Standard **CEI EN 61386**
- Resistenza alla trazione **1000 N**
- Resistenza al carico sospeso **450 N**
- Resistenza alla corrosione **4 Alta**

- Standard **IEC EN 61386**
- Tensile strength **1000 N**
- Resistance to suspended load **450 N**
- Corrosion resistance **4 High**

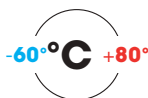

IP66
IP68
IP69

Filettatura metrica Metric thread

CODICE CODE	DIAMETRO NOMINALE NOMINAL DIAMETER		DIMENSIONI mm DIMENSIONS mm				CONFEZIONE PACKAGE
	Ød mm	F	ØPU	CH1	CH2	LF	pz / pcs.
6014XX16A	12	M16 x 1,5	10	27	27	9	25
6014XX1616*	16	M16 x 1,5	12	30	30	10	25
6014XX20A	16	M20 x 1,5	13,8	30	30	10	20
6014XX2020*	21	M20 x 1,5	16	36	36	10	20
6014XX25A	21	M25 x 1,5	18	36	36	12	25
6014XX32A	27	M32 x 1,5	24	46	46	13	15
6014XX4035	35	M40 x 1,5	32	50	55	14	5
6014XX5040	40	M50 x 1,5	38	58	60	18	5

*A Richiesta / On Request

Filettatura metrica Metric thread

CEI EN 61386



CEI EN 61386



Filettatura Gas ISO 228 Gas ISO 228 thread

CODICE CODE	DIAMETRO NOMINALE NOMINAL DIAMETER		DIMENSIONI mm DIMENSIONS mm				CONFEZIONE PACKAGE
	Ød mm	F	ØPU	CH1	CH2	LF	pz / pcs.
6014XX16*	16	1/2"	12	30	30	10	20
6014XX22*	21	3/4"	16	36	36	12	20
6014XX32*	27	1"	24	46	46	12	15
6014XX38*	35	1" 1/4	32	50	50	14	5
6014XX40*	40	1" 1/2	38	60	60	14	5
6014XX50*	51	2"	48	70	70	18	1

*A Richiesta / On Request

Raccordi metallici Metal fittings

Maschio girevole in acciaio inox AISI 316L 6014XXG AISI 316L stainless steel Swivel male 6014XXG



Sono prodotti in acciaio inox AISI 316L, per essere utilizzati nei luoghi in cui i raccordi tradizionali in ottone nichelato non sono ritenuti sufficientemente resistenti alle condizioni ambientali. Le caratteristiche di funzionamento sono identiche a quelle dei raccordi in ottone nichelato Cod. 6014-G. Elemento girevole protetto da guarnizione O-ring interna al raccordo.

Made in AISI 316L stainless steel, to be used in situations where traditional nickel plated brass fittings are considered to be insufficiently resistant to the environmental conditions. The operating characteristics are identical to those of the nickel-plated brass fittings code 6014-G. Swivel element protected by an O-ring inside the fitting.

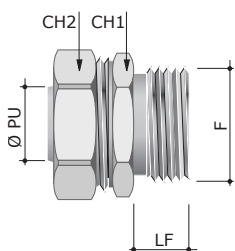

- Standard **CEI EN 61386**
- Resistenza alla trazione **1000 N**
- Resistenza al carico sospeso **450 N**
- Resistenza alla corrosione **4 Alta**

- Standard **IEC EN 61386**
- Tensile strength **1000 N**
- Resistance to suspended load **450 N**
- Corrosion resistance **4 High**

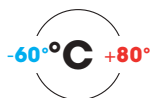

IP66
IP68
IP69

Filettatura metrica Metric thread

CODICE CODE	DIAMETRO NOMINALE NOMINAL DIAMETER Ød mm	F	DIMENSIONI mm DIMENSIONS mm				LF	CONFEZIONE PACKAGE pz / pcs.
			ØPU	CH1	CH2	CH3		
6014XX20G*	16	M20 x 1,5	13,8	30	30	26	10	10
6014XX25G*	21	M25 x 1,5	18,0	36	36	32	12	10
6014XX2732G*	27	M32 x 1,5	24,0	46	46	40	13	10
6014XX4035G*	35	M40 x 1,5	32,0	50	52	50	14	7
6014XX5040G*	40	M50 x 1,5	38,0	60	60	55	18	5
6014XX6350G*	51	M63 x 1,5	48,0	70	74	70	18	1

*A Richiesta / On Request

Filettatura metrica Metric thread

CEI EN 61386	
CEI EN 61386	

Filettatura Gas ISO 228 Gas ISO 228 threads

CODICE CODE	DIAMETRO NOMINALE NOMINAL DIAMETER Ød mm	F	DIMENSIONI mm DIMENSIONS mm				LF	CONFEZIONE PACKAGE pz / pcs.
			ØPU	CH1	CH2	CH3		
6014XX16G*	16	1/2"	13,8	30	30	26	10	10
6014XX22G*	21	3/4"	18	36	36	32	12	10
6014XX32G*	27	1"	24	46	46	40	12	10
6014XX38G*	35	1" 1/4	32	50	52	50	14	7
6014XX40G*	40	1" 1/2	38	60	60	55	14	5
6014XX50G*	51	2"	48	70	74	70	18	1

*A Richiesta / On Request

Raccordi Pressacavo

Gland fittings

Per tubi metallici flessibili **6014P**

For flexible metal conduits **6014P**



Questi accessori sono utilizzati quando è necessario rendere stagna una parte dell'impianto.

Particolari realizzati in ottone nichelato. Le caratteristiche di funzionamento sono identiche a quelle dei raccordi cod. 6014; questi particolari raccordi includono un adattatore pressacavo con terminale filettato maschio.

These accessories are designed for use when it becomes necessary to make the system water tight.

Made of nickel plated brass. The operating characteristics are identical to those of the fittings code 6014. These special fittings include a cable gland adapter with male threaded head.

- Standard
CEI EN 61386 e CEI EN 62444
- Grado di protezione EN 60529 **IP66/IP68**

- Standard
IEC EN 61386 and IEC EN 62444
- IP degree IEC EN 60529 **IP66/IP68**

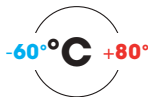
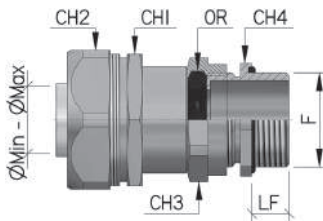

IP66
IP68

CEI EN 61386



CEI EN 61386



Filettatura metrica Metric thread

CODICE CODE	DIAMETRO NOMINALE NOMINAL DIAMETER	SERRAGGIO TIGHTENING	F	DIMENSIONI mm DIMENSIONS mm				LF	CONFEZIONE PACKAGE
	Ød mm	ØMin- ØMax		CH1	CH2	CH3	CH4		pz / pcs.
6014P10M120509	10	05 ÷ 09	M 12x1,5	22,0	24	20	20	10	30
6014P10M160509	10	05 ÷ 09	M 16x1,5	22,0	24	20	20	10	30
6014P10M200812	10	08 ÷ 12	M 20x1,5	22,0	24	24	24	10	30
6014P12M120509	12	05 ÷ 09	M 12x1,5	24,0	26	20	20	10	30
6014P12M160509	12	05 ÷ 09	M 16x1,5	24,0	26	20	20	10	30
6014P12M200812	12	08 ÷ 12	M 20x1,5	24,0	26	24	24	10	30
6014P16M120509	16	05 ÷ 09	M 12x1,5	28,0	30	20	20	10	30
6014P16M160509	16	05 ÷ 09	M 16x1,5	28,0	30	20	20	10	30
6014P16M200812	16	08 ÷ 12	M 20x1,5	28,0	30	24	24	10	30
6014P16M251116	16	11 ÷ 16	M 25x1,5	28,0	30	30	30	10	20
6014P22M200812	21	08 ÷ 12	M 20x1,5	35,0	37	24	24	10	20
6014P22M201116	21	11 ÷ 16	M 20x1,5	35,0	37	30	30	10	20
6014P22M251116	21	11 ÷ 16	M 25x1,5	35,0	37	30	30	10	20
6014P22M321521	21	15 ÷ 21	M 32x1,5	35,0	37	36	36	10	10
6014P32M201116	27	11 ÷ 16	M 20x1,5	42,0	45	30	30	10	10
6014P32M251116	27	11 ÷ 16	M 25x1,5	42,0	45	30	30	10	10
6014P32M251521	27	15 ÷ 21	M 25x1,5	42,0	45	36	36	10	10
6014P32M321521	27	15 ÷ 21	M 32x1,5	42,0	45	36	36	10	10
6014P32M402027	27	20 ÷ 27	M 40x1,5	42,0	45	45	45	12	10
6014P38M321521	35	15 ÷ 21	M 32x1,5	50,0	52	36	36	10	7
6014P38M402027	35	20 ÷ 27	M 40x1,5	50,0	52	45	45	12	7
6014P40M402027	40	20 ÷ 27	M 40x1,5	58,0	61	45	45	12	5

Raccordi metallici Metal fittings

Curvo a 45° in ottone nichelato **6024** 45° elbow in nickel plated brass **6024**



Il loro utilizzo è consigliato per una corretta applicazione dei tubi pieghevoli evitando pieghe e torsioni che danneggerebbero sia i tubi che i cavi al loro interno, ottenendo inoltre una riduzione di ingombro nei cablaggi.
Continuità elettrica garantita

Using these fittings is recommended for a correct application of flexible conduits avoiding bending and twisting that could damage the conduits and cables inside them, also obtaining a reduction of dimensions in the wiring harnesses.
Electrical continuity guaranteed

- Standard **CEI EN 61386**
- Grado IP EN 60529 **IP66/IP68/IP69**
- Filetto Metrico ISO norme **CEI EN 60423**

- Standard **IEC EN 61386**
- IP degree EN 60529 **IP66/IP68/IP69**
- Metric Thread ISO standards **IEC EN 60423**

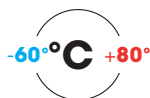
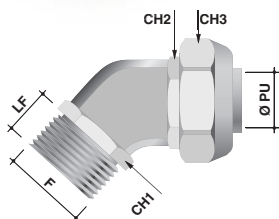

IP66
IP68
IP69

Filettatura metrica Metric thread

CODICE CODE	DIAMETRO NOMINALE NOMINAL DIAMETER Ød mm	F	DIMENSIONI mm DIMENSIONS mm				LF	CONFEZIONE PACKAGE pz / pcs.
			ØPU	CH1	CH2	CH3		
6024-1610	10	M16 x 1,5	8,5	19	22	24	10	10
6024-1612	12	M16 x 1,5	10,0	19	24	26	10	10
6024-1616	16	M16 x 1,5	11,5	19	28	30	10	10
6024-2016	16	M20 x 1,5	13,8	23	28	30	10	10
6024-2020	21	M20 x 1,5	15,0	23	35	37	10	10
6024-2520	21	M25 x 1,5	18,0	28	35	37	10	10
6024-2527	27	M25 x 1,5	20,0	28	42	45	10	10
6024-3227	27	M32 x 1,5	24,0	36	42	45	10	10

CEI EN 61386



CEI EN 61386



Raccordi metallici Metal fittings

Curvo a 90° in ottone nichelato **6025** 90° elbow in nickel plated brass **6025**

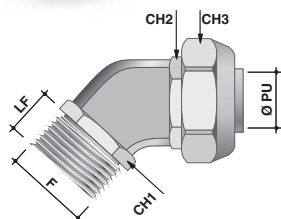

Il loro utilizzo è consigliato per una corretta applicazione dei tubi pieghevoli evitando pieghe e torsioni che danneggerebbero sia i tubi che i cavi al loro interno, ottenendo inoltre una riduzione di ingombro nei cablaggi.

Realizzato mediante l'accoppiamento di due elementi curvi a 45° perfettamente allineati, la tenuta è garantita da una guarnizione o-ring.
Continuità elettrica garantita

- Standard **CEI EN 61386**
- Grado IP EN 60529 **IP66/IP68/IP69**
- Filetto Metrico ISO norme **CEI EN 60423**

Using these fittings is recommended for a correct application of flexible conduits avoiding bending and twisting that could damage the conduits and cables inside them, also obtaining a reduction of dimensions in the wiring harnesses.

Made by the coupling of two perfectly aligned 45° curved elements, the seal is guaranteed by an o-ring seal.

Electrical continuity guaranteed

- Standard **IEC EN 61386**
- IP degree EN 60529 **IP66/IP68/IP69**
- Metric Thread ISO standards **IEC EN 60423**

Filettatura metrica Metric thread

CODICE CODE	DIAMETRO NOMINALE NOMINAL DIAMETER		ØPU	DIMENSIONI mm DIMENSIONS mm			LF	CONFEZIONE PACKAGE pz / pcs.
	Ød mm	F		CH1	CH2	CH3		
6025-1610	10	M16 x 1,5	8,5	19	22	24	10	10
6025-1612	12	M16 x 1,5	10,0	19	24	26	10	10
6025-1616	16	M16 x 1,5	11,5	19	28	30	10	10
6025-2016	16	M20 x 1,5	13,8	23	28	30	10	10
6025-2020	21	M20 x 1,5	15,0	23	35	37	10	10
6025-2520	21	M25 x 1,5	18,0	28	35	37	10	10
6025-2527	27	M25 x 1,5	20,0	28	42	45	10	10
6025-3227	27	M32 x 1,5	24,0	36	42	45	10	10

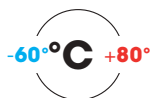

IP66
IP68
IP69

CEI EN 61386



CEI EN 61386



■ Raccordi metallici per tubi pieghevoli Metal fittings for bendable conduits

A doppio bloccaggio per tubi metallici pieghevoli protetti con treccia Double locking for bendable metal conduits protected with braid

Consentono il doppio bloccaggio del tubo e della treccia metallica che lo riveste. Tutti i raccordi sono in ottone nichelato.

The fittings ensure double locking of the conduit and of the metal braid covering it. All connectors are made of nickel-plated brass.

Questa soluzione presenta una serie di vantaggi:

- Eccellente resistenza a trazione
- Elevato grado IP con tutti i tipi di rivestimento del tubo
- Impedisce forature da contatto accidentale con l'estremità della treccia
- Serraggio treccia sull'intera circonferenza

This solution has various advantages:

- Excellent resistance to traction
- High IP rating with all types of conduit coatings
- Prevents piercing caused by accidental contact with the end of the braid
- Braid sleeving around the whole circumference

Filettatura

Disponibili diverse filettature

Thread

Different thread types available.

Corpo intermedio

- in ottone nichelato
- alta resistenza meccanica
- elevata resistenza alle sostanze aggressive
- serraggio treccia sull'intera circonferenza

Intermediate body

- In nickel plated brass;
- high mechanical resistance;
- high resistance to aggressive substances;
- braid tightening over the entire circumference

Dado di serraggio

- in ottone nichelato
- elevata resistenza alle sostanze aggressive
- elevata resistenza alla trazione e al carico sospeso

Tightening Nut

- In nickel plated brass;
- high resistance to aggressive substances
- high tensile strength and resistance to suspended load



Corpo del raccordo

- in ottone nichelato;
- liscio internamente per evitare il danneggiamento dei cavi;
- elevata durata e affidabilità;
- elevata resistenza alle sostanze aggressive

Connector body

- made of nickel plated brass;
- Internally smooth to avoid damage of cables;
- high durability and reliability;
- high resistance to aggressive substances

Boccola di bloccaggio in nylon

- La particolare forma troncoconica garantisce il bloccaggio esterno del tubo, garantendo una tenuta stagna IP66/IP68/IP69

Nylon clamping bushing

- The particular truncated conical shape; guarantees the external locking of conduit, providing IP66/IP68/IP69 seal.

Viola di contatto metallico in zama zincata

- Protezione contro possibili danneggiamenti dei cavi
- avvitata all'interno del tubo, garantisce una elevata resistenza alla trazione e continuità elettrica

Metal contact base in galvanized zamak

- Protection against possible damage to the cables
- screwed inside the conduit, ensures high tensile strength and electricity continuity

Raccordi metallici per tubi pieghevoli

Metal fittings for bendable conduits

Versione Raccordo

Fitting version

TUBI UTILIZZATI
USABLE CONDUIT

GRADO DI PROTEZIONE
PROTECTION DEGREE

TEMPERATURA DEL SISTEMA
SYSTEM TEMPERATURE



T0

Tubi con rivestimento
plastico LISCIO
Conduits with
SMOOTH plastic coating



607ETX

IP66
IP68
IP69

-25°C +70°C



T1

Tubi con rivestimento
plastico ASPIRATO
Conduits with
ASPIRATED plastic coating



6071T



6071ET



6071ETX

IP66
IP68
IP69

-25°C +70°C



TN

Tubi privi di rivestimento
plastico
Conduits without coating in
plastic



667DXFTX



607T

IP40

-60°C +250°C

Raccordi metallici Metal fittings

Maschio girevole a doppio bloccaggio T_6014-G Double locking swivel male T_6014-G

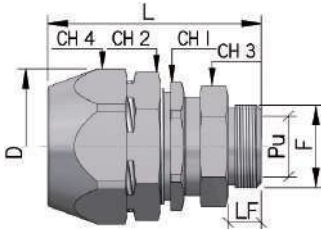

Raccordi realizzati in ottone nichelato, consentono il doppio bloccaggio del tubo e della treccia metallica che lo riveste. Questa soluzione tecnica presenta molteplici punti di forza come un'eccellente resistenza alla trazione, un elevato grado IP con tutti i tipi di rivestimento del tubo, impedisce forature da contatto accidentale con l'estremità della treccia e un serraggio treccia sull'intera circonferenza. Filetto metrico ISO conforme a CEI EN 60423. Continuità elettrica garantita per EMC.

Inserire il codice che identifica la versione (T0/T1/TN) davanti al codice del raccordo standard.

Esempio

Cod. versione T1 e cod. raccordo 6014-25A, il codice del raccordo completo diventa T16014-25A

Fittings made of nickel plated brass which ensure double locking of the conduit and of the protective metal braid covering it. This technical solution has a number of strong points like an excellent tensile strength, high IP degree with all types of conduit coatings, prevents piercing caused by accidental contact with the end of the braid sleeving and a braid tightening on the entire circumference. ISO metric thread according to IEC EN 60423. Guaranteed electrical continuity for EMC.

Enter the code that identifies the version (T0/T1/TN) before the standard fitting code.

Example

Code version T1 and cod. fitting 6014-25A, the code of the complete fitting becomes T16014-25A



IP66
IP68
IP69



IP66
IP68
IP69



IP40

- Standard
CEI EN 61386 e CEI EN 60423
- Grado IP del sistema CEI EN 60529
T0 e T1 = IP66/IP68/IP69
TN = IP44

- Standard
IEC EN 61386 and IEC EN 60423
- IP degree CEI EN 60529
T0 and T1 = IP66/IP68/IP69
TN = IP44

IEC TS 61587



Filettatura metrica Metric thread

VERSIONE VERSION	CODICE CODE	DIAMETRO NOMINALE NOMINAL DIAMETER Ød mm	DIMENSIONI mm DIMENSIONS mm									PESO WEIGHT kg/pz pcs.	CONFEZIONE PACKAGE pz / pcs.
			F	ØPU	CH1	CH2	CH3	CH4	LF	L	D		
T 0	6014-1016G	10	M16 x 1,5	8,5	22	26	22	28	10	58,5	31	0,128	30
	6014-1216G	12	M16 x 1,5	10,0	24	28	22	30	10	59,5	34	0,139	30
	6014-20G	16	M20 x 1,5	13,8	28	30	26	35	10	64,5	35	0,200	10
T 1 +	6014-25G	21	M25 x 1,5	18,0	35	39	32	42	10	67,0	47	0,296	10
	6014-2732G	27	M32 x 1,5	24,0	42	50	39	50	13	75,5	56	0,468	10
T N	6014-4035G	35	M40 x 1,5	32,0	50	55	50	60	14	76,0	64	0,648	7
	6014-5040G	40	M50 x 1,5	38,0	58	60	55	65	18	87,5	72	0,766	5
	6014-6350G	51	M63 x 1,5	48,0	70	80	65	80	18	93,5	87	1,321	1

Raccordi metallici Metal fittings

Maschio fisso a doppio bloccaggio T_6014

Double locking fixed male T_6014



Inserire il codice che identifica la versione (T0/T1/TN) davanti al codice del raccordo standard.

Enter the code that identifies the version (T0 / T1 / TN) in front of the standard fitting code.

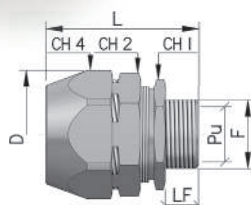

Filettatura metrica Metric thread

VERSIONE VERSION	CODICE CODE	DIAMETRO NOMINALE NOMINAL DIAMETER Ød mm	DIMENSIONI mm DIMENSIONS mm								PESO* WEIGHT* kg/pz. pcs.	CONFEZIONE PACKAGE pz / pcs.
			F	ØPU	CH1	CH2	CH4	LF	L	D		
T 0	6014-1016	10	M16 X 1,5	8,5	22	26	28	9	44	31	0,094	20
	6014-16A	12	M16 X 1,5	10,0	24	28	30	9	45	34	0,107	50
	6014-20A	16	M20 X 1,5	13,8	28	30	35	10	51	39	0,164	25
	6014-2020	21	M20 X 1,5	16,0	35	39	42	10	54	47	0,236	10
	6014-25A	21	M25 X 1,5	18,0	36	39	42	12	56	47	0,247	10
T 1 +	6014-32A	27	M32 X 1,5	24,0	42	50	50	12	61	56	0,392	10
	6014-4035	35	M40 X 1,5	32,0	50	55	60	14	61	64	0,498	5
T N	6014-40A	40	M40 X 1,5	34,0	58	60	65	14	66	72	0,578	5
	6014-5040	40	M50 X 1,5	38,0	58	60	65	18	70	72	0,609	5
	6014-50A	51	M50 X 1,5	44,0	70	80	80	18	75	76	0,998	5
	6014-6350	51	M63 X 1,5	48,0	70	80	80	18	75	76	1,083	1

-60° T0 +70°

IP66
IP68
IP69

-60° T1 +70°

IP66
IP68
IP69

-60° TN +250°

IP40

IEC TS 61587



Tubo rigido - tubo flessibile a doppio bloccaggio T_6117

Rigid conduit - double locking flexible conduit T_6117



Inserire il codice che identifica la versione (T0/T1/TN) davanti al codice del raccordo standard.

Enter the code that identifies the version (T0/T1/TN) before the standard fitting code.

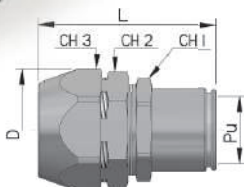

VERSIONE VERSION	CODICE CODE	DIAMETRO NOMINALE NOMINAL DIAMETER Ød mm	TUBO RIGIDO RIGID CONDUIT ØD mm	DIMENSIONI mm DIMENSIONS mm						PESO* WEIGHT* kg/pz. pcs.	CONFEZIONE PACKAGE pz / pcs.
				ØPU	CH1	CH2	CH3	L	D		
T 0	6117-10N	10	16	8,5	24	26	28	60	31	0,120	25
	6117-12N	12	16	10,0	24	28	30	61	34	0,130	25
	6117-16N	16	16	13,8	28	30	35	65	39	0,180	25
	6117-2020	21	20	18,0	35	39	42	65	47	0,270	15
	6117-25N	21	25	18,0	35	39	42	68	47	0,270	15
T 1 +	6117-32N	27	32	24,0	42	50	50	77	56	0,425	10
	6117-3235	35	32	32,0	50	55	60	76	64	0,510	5
T N	6117-4035	35	40	32,0	50	55	60	81	72	0,592	5
	6117-40	40	40	38,0	60	60	65	85	72	0,685	5
	6117-5040	40	50	38,0	58	60	65	85	76	0,696	5
	6117-50	51	50	48,0	70	80	80	87	76	1,089	5

-60° T0 +70°

IP66
IP68
IP69

-60° T1 +70°

IP66
IP68
IP69

-60° TN +250°

IP40

IEC TS 61587



■ Raccordi plastici Plastic fittings

Per tubi flessibili in PVC (V0 UL94) **6188**

For PVC flexible conduits (V0 UL94) **6188**



IP65

Questi raccordi sono considerati universali in quanto, oltre a poter essere utilizzati su diversi tipi di tubi flessibili, hanno la particolarità di poter essere impiegati, a seconda delle necessità, fissi o girevoli. Costituiti da un corpo dotato di settori elastici dentellati, da un dado di serraggio e da un elemento terminale filettato che, oltre ad essere girevole, ha anche la possibilità di avere una piccola escursione assiale utilizzata per renderlo fisso.

Il collegamento raccordo-tubo è ottenuto avvitando il dado sul corpo del raccordo, questo avvitarmento provoca la deformazione concentrica dei settori elastici ed il conseguente bloccaggio del tubo, assicurando una perfetta tenuta meccanica. Perfetto infilaggio dei cavi senza rischio di danneggiamento del rivestimento.

Filettature

- Metrica ISO CEI EN 60423 (con controdado)
- GAS cilindrico UNI ISO 228 (con controdado)
- PG DIN 40430

Colori

- Grigio RAL7001
- Grigio RAL7035 e Nero a richiesta

- Standard **CEI EN 61386**
- Autoestinguenza secondo CEI EN 61386
Non propagante la fiamma
- Autoestinguenza UL94 **V0**
- Grado IP CEI EN 60529 **IP65**

These fittings are considered to be universal, because, in addition to the possibility of being used on different types of flexible conduits they can also be used as fixed or swiveling, depending on the requirements. They consist of a body with clogged elastic sections, a clamping nut and a threaded end fitting, which, in addition to swiveling, can also become fixed through the fitting of a small axial extension.

The conduit is coupled to the connector by tightening the nut on the body of the connector. This causes the concentric deformation of the elastic sectors, blocks the conduit, and results in a perfect mechanical seal. The particular care and attention that goes into producing these fittings ensures a perfect fitting of cables without any risk of coating damage.

Threads

- ISO metric IEC EN 60423 (with locknut)
- UNI ISO 228 GAS cylindrical (with locknut)
- PG in accordance with DIN 40430

Colours

- Grey RAL7001
- Grey RAL7035 and Black on request

- Standard **IEC EN 61386**
- Self-extinguishing IEC EN 61386
No flame propagation
- Self-extinguishing UL94 **V0**
- IP degree IEC EN 60529 **IP65**

Filettatura metrica completa con ghiera Metric thread complete with ring nut

CODICE RAL 7001 CODE RAL 7001	CODICE RAL 7035 CODE RAL 7035	CODICE NERO CODE BLACK	DIAMETRO NOMINALE NOMINAL DIAMETER Ød mm	DIMENSIONI mm DIMENSIONS mm F	ØPU	CONFEZIONE PACKAGE pz / pcs.
-	6188-1012B	6188-1012N	10	M12 x 1,5	8	50
-	6188-1216B	6188-1216N	12	M16 x 1,5	10	50
6188-1520G	6188-1520B	6188-1520N	16	M20 x 1,5	13	50
-	6188-2025B	6188-2025N	20	M25 x 1,5	18	50
-	6188-2532B	6188-2532N	25	M32 x 1,5	23	25
6188-2732G	6188-2732B	-	27	M32 x 1,5	26	25
-	6188-3240B	6188-3240N	32	M40 x 1,5	30	25
6188-4050G	6188-4050B	6188-4050N	40	M50 x 1,5	38	15
6188-5063G	6188-5063B	6188-5063N	50	M63 x 1,5	47	10

■ Raccordi plastici Plastic fittings

Per tubi flessibili in PVC (V0 UL94) **6188**

For PVC flexible conduits (V0 UL94) **6188**

Filettatura GAS ISO 228 completo di ghiera GAS ISO 228 thread complete with ring nut

CODICE RAL 7001 CODE RAL 7001	CODICE RAL 7035 CODE RAL 7035	CODICE NERO CODE BLACK	DIAMETRO NOMINALE NOMINAL DIAMETER Ød mm	DIMENSIONI mm DIMENSIONS mm F ØPU		CONFEZIONE PACKAGE pz / pcs.
6188-10G	6188-10B	6188-10N	10	1/4"	8	50
6188-101G	6188-101B	6188-101N	10	3/8"	8	50
6188-12G	6188-12B	6188-12N	12	3/8"	10	50
6188-15G	6188-15B	6188-15N	16	1/2"	13	50
6188-20G	6188-20B	6188-20N	20	3/4"	18	50
-	6188-251B	6188-251N	25	1"	23	25
6188-27G	-	6188-27N	27	1"	26	25
-	6188-32B	6188-32N	32	1" 1/4	30	25
6188-35G	-	6188-35N	35	1" 1/4	33	20
6188-40G	6188-40B	6188-40N	40	1" 1/2	38	15
6188-50G	6188-50B	6188-50N	50	2"	47	10

Filettatura PG senza ghiera PG thread without ring nut

CODICE RAL 7001 CODE RAL 7001	CODICE RAL 7035 CODE RAL 7035	CODICE NERO CODE BLACK	DIAMETRO NOMINALE NOMINAL DIAMETER Ød mm	DIMENSIONI mm DIMENSIONS mm F ØPU		CONFEZIONE PACKAGE pz / pcs.
6188-1009G	6188-1009B	6188-1009N	10	09	8	50
6188-1011G	6188-1011B	6188-1011N	10	11	8	50
6188-1211G	6188-1211B	6188-1211N	12	11	10	50
6188-1213G	6188-1213B	6188-1213N	12	13	10	50
6188-1513G	6188-1513B	6188-1513N	16	13	13	50
6188-1516G	6188-1516B	6188-1516N	16	16	13	50
6188-2021G	6188-2021B	6188-2021N	20	21	18	50
-	6188-2529B	6188-2529N	27	29	23	25
-	6188-3229B	6188-3229N	32	29	30	25
6188-3536G	-	6188-3536N	35	36	33	20
6188-4036G	6188-4036B	6188-4036N	40	36	38	15
6188-5048G	6188-5048B	6188-5048N	50	48	47	10

Raccordi metallici Metal fittings

Portagomma per tubi in PVC liscio 6057

Smooth PVC hose for conduits 6057

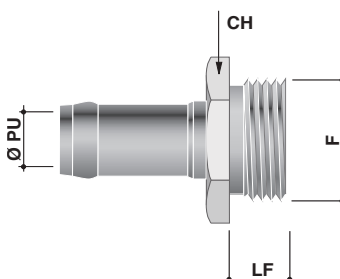

IP67

Prodotti in ottone, nichelati successivamente per conferire una migliore resistenza alle avverse condizioni ambientali in cui saranno utilizzati.

Il collegamento raccordo-tubo flessibile avviene mediante il serraggio di una fascetta metallica che stringe il tubo sul raccordo, la cui particolare superficie esterna favorisce una perfetta tenuta allo sfilamento.

Con i tubi rivestiti con treccia di acciaio cod.6089, si devono utilizzare gli appositi anelli cod.6058 che hanno il compito di contenere i fili della treccia; in questi casi si consiglia l'utilizzo di fascette provviste di vite di messa a terra cod.6059-T per il collegamento equipotenziale. Perfetto infilaggio dei cavi senza rischio di danneggiamento del rivestimento.

Filettature

- Metrico ISO CEI EN 60423
- GAS cilindrico UNI ISO 228
- PG DIN 40430

■ Grado IP CEI EN 60529 **IP67**

Made of brass which is then nickel plated in order to improve resistance to the harsh environmental conditions in which they are used.

The fitting is coupled to the flexible conduit by tightening a metal clamp that secures the conduit to the fitting. This clamp has a surface designed to prevent it from slipping.

With the conduits covered with steel braid code 6089, the appropriate rings code 6058 must be used, which have the task of containing the braid wires; in these cases it is advisable to use cable ties equipped with earthing screw code 6059-T for equipotential bonding. The particular care and attention that goes into producing these fittings ensures a perfect fitting of cables without any risk of coating damage.

Threads

- ISO metric IEC EN 60423
- UNI ISO 228 GAS cylindrical
- PG in accordance with DIN 40430

■ IP degree IEC EN 60529 **IP67**

Filettatura Metrica Metric thread

CODICE CODE	DIAMETRO NOMINALE NOMINAL DIAMETER Ød mm	F	DIMENSIONI mm DIMENSIONS mm			CONFEZIONE PACKAGE pz / pcs.
			ØPU	CH	LF	
6057-1012	10	M12 x 1,5	8	19	7	20
6057-1016	10	M16 x 1,5	8	19	7	20
6057-1216	12	M16 x 1,5	10	22	10	20
6057-1520	16	M20 x 1,5	13	24	10	20
6057-2020	20	M20 x 1,5	16	27	10	10
6057-2025	20	M25 x 1,5	17	30	12	10
6057-2725	27	M25 x 1,5	21	35	12	10
6057-2732	27	M32 x 1,5	23	36	12	10
6057-3632	35	M32 x 1,5	26	44	12	5

Filettatura PG PG thread

CODICE CODE	DIAMETRO NOMINALE NOMINAL DIAMETER Ød mm	F	DIMENSIONI mm DIMENSIONS mm			CONFEZIONE PACKAGE pz / pcs.
			ØPU	CH	LF	
6057-1009	10	09	8	19	7	20
6057-1211	12	11	10	22	7	20
6057-1213	12	13,5	10	24	7	20
6057-1513	16	13,5	13	24	7	20
6057-2013	20	13	16	27	7	10
6057-2016	20	16	16	27	7	10
6057-2821	27	21	23	36	10	10
6057-3529	35	29	30	45	11	5

Raccordi metallici Metal fittings

Portagomma per tubi in PVC liscio 6057

Smooth PVC hose for conduits 6057

Filettatura GAS ISO 228 GAS ISO 228 thread

CODICE CODE	DIAMETRO NOMINALE NOMINAL DIAMETER Ød mm	F	DIMENSIONI mm DIMENSIONS mm			CONFEZIONE PACKAGE pz / pcs.
			ØPU	CH	LF	
6057-10	10	1/4"	8	19	7	20
6057-12	12	3/8"	10	22	10	20
6057-121	12	1/2"	10	24	10	20
6057-15	16	1/2"	13	24	10	20
6057-20	20	1/2"	16	27	10	10
6057-201	20	3/4"	17	30	12	10
6057-28	27	3/4"	21	36	12	10
6057-281	27	1"	23	36	12	10
6057-35	35	1"	26	44	12	10
6057-40	40	1" 1/4	35	50	13	5

Stringitubo 6059

Hose clamp 6059



Fascetta e carrello sono realizzati in acciaio INOX AISI 430, con bordi arrotondati per non danneggiare la superficie del tubo flessibile. Vite esagonale in acciaio zincato con taglio a cacciavite.

Clamp and slide are made of stainless steel AISI 430, with rounded edges in order not to damage the surface of the hose. Galvanized steel hex screw with flat blade.

CODICE CODE	SERRAGGIO TIGHTENING	CONFEZIONE PACKAGE pz / pcs.
	Ø d min - Ø D max, mm	
6059-10	11 ÷ 17	100
6059-12	13 ÷ 20	100
6059-15	19 ÷ 28	100
6059-20	22 ÷ 32	50
6059-28	32 ÷ 44	50
6059-36	38 ÷ 50	50
6059-40	44 ÷ 56	50
6059-47	50 ÷ 65	50
6059-58	58 ÷ 75	25

Stringitubo con vite di terra 6059T

Hose clamps with grounding screw 6059T



Fascetta e carrello sono realizzati in acciaio zincato, con bordi arrotondati e vite esagonale in acciaio zincato con taglio a cacciavite. La vite di messa terra è saldata elettricamente alla fascetta, completa di rondella e dado CH 7mm. Coppia di serraggio della vite = 4Nm

Clamp and slide are made of galvanized steel, with rounded edges and hex screw in galvanized steel hex screw with flat blade head.

The earthing screw is electrically welded to the clamp, washer and nut CH 7mm.

Screw tightening torque = 4Nm

CODICE CODE	SERRAGGIO TIGHTENING	CONFEZIONE PACKAGE pz / pcs.
	Ø d min - Ø D max, mm	
6059-12T	13 ÷ 20	100
6059-15T	19 ÷ 28	100
6059-28T	32 ÷ 44	50
6059-36T	44 ÷ 56	50
6059-40T	58 ÷ 75	50

■ Accessori Accessories

Boccole in ottone nichelato **66BOTT** Nickel plated brass bushing **66BOTT**



Realizzati in ottone nichelato, questi particolari monopezzo opportunamente sagomati, assicurano il bloccaggio esterno del tubo flessibile non rivestito, garantendo una buona tenuta meccanica e la continuità elettrica prevista dalle norme CEI. Possono essere utilizzati con qualsiasi raccordo per tubi metallici pieghevoli, in sostituzione della boccola in nylon normalmente in dotazione.

Prodotti conformi alle norme CEI EN 61386
Continuità elettrica garantita

Made of nickel plated brass, these specially shaped individual parts ensure external blocking of the flexible conduit, guaranteeing a good mechanical seal and the electrical continuity specified in IEC standards.

They can be fitted onto any type of fitting for metal flexible conduits, to replace the nylon bushing normally supplied as standard.

In compliance with IEC EN 61386
Electrical continuity guaranteed

CODICE CODE	DIAMETRO NOMINALE NOMINAL DIAMETER	CONFEZIONE PACKAGE
	Ød mm	pz / pcs.
66BOTT10	10	50
66BOTT12	12	50
66BOTT16	16	50
66BOTT20	21	50
66BOTT32	27	50
66BOTT38	35	25
66BOTT40	40	25
66BOTT50	51	15

Manicotti di tenuta (V0 UL94) **66BTP** Sealing couplings (V0 UL94) **66BTP**



Prodotto in materiale termoplastico, non propagante la fiamma, privo di sostanze alogene, silicone e cadmio. Questa soluzione tecnica aumenta il grado di tenuta ad IP66/IP68/IP69 nell'accoppiamento tra raccordi e tubi metallici pieghevoli con rivestimento aspirato. Utilizzabile con qualsiasi raccordo per tubo flessibile e pieghevole. Continuità elettrica del sistema garantita

- Standard **CEI EN 61386**
- Autoestinguenza **UL94 V0**

Made of thermoplastic material, free of halogen, silicon and cadmium substances. This solution increases the level of tightness to IP66/ IP68/IP69 in coupling between fittings and flexible metal with aspirated coating.

It can be used with any fitting for flexible and foldable conduits.

Electrical continuity guaranteed

- Standard **IEC EN 61386**
- Self-extinguishing **UL94 V0**

CODICE CODE	DIAMETRO NOMINALE NOMINAL DIAMETER	CONFEZIONE PACKAGE
	Ød mm	pz / pcs.
66BTSP10	10	12
66BTSP12	12	12
66BTSP16	16	6
66BTSP22	21	4
66BTSP32	27	4
66BTSP38	35	4
66BTSP40	40	4
66BTSP50	51	2



**IP66
IP68
IP69**

■ Accessori Accessories

Virole terminali S66V Bushings S66V



Accessori terminali realizzati in lamiera deformata. Sono applicati per avvitamento alle estremità dei tubi metallici pieghevoli per evitare il contatto tra i cavi e gli spigoli del tubo.

End accessories made of moulded metal sheet. These are screwed into the ends of the flexible metal conduits to prevent any contact between the cables and the edges of the conduit.

CODICE CODE	DIAMETRO NOMINALE NOMINAL DIAMETER Ød mm	CONFEZIONE PACKAGE pz / pcs.
S66V10	10	200
S66V12	12	200
S66V16	16	150
S66V22	21	100
S66V32	27	75
S66V38	35	50
S66V40	40	25
S66V50	51	10

Anello salvamano 6058 O-ring 6058



Accessori realizzati in lamiera deformata applicati sull'estremità dei tubi 6089, contengono i fili della treccia metallica

End accessories made of moulded metal sheet screwed into the ends of the 6089 conduits, contain the wires of the metal braid.

CODICE CODE	DIAMETRO NOMINALE NOMINAL DIAMETER Ød mm	CONFEZIONE PACKAGE pz / pcs.
6058-10	10	20
6058-12	12	20
6058-15	16	20
6058-20	20	10
6058-28	27	10
6058-35	35	5
6058-40	40	5

■ Tubo rigido Rigid conduit



In acciaio zincato non filettabili 6008-L Non-threadable galvanised steel 6008-L

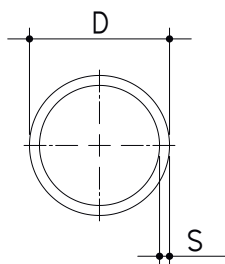

IP66
IP68
IP69

CEI EN 61386	
CEI EN 61386	
CEI EN 61386	
IEC TS 61587	



Tubi non filettabili, ideati per la curvatura a freddo anche in esecuzioni con raggi ridotti (2,5-3 volte il Ø del tubo).

Ricavati da lamiera zincata a caldo per immersione in continuo (UNI EN 10346) con riporto di zinco sulla saldatura.

Il nuovo rivestimento ZL costituisce una barriera contro gli agenti ossidanti per l'acciaio, non solo nelle superfici rivestite ma anche in prossimità dei bordi di taglio (protezione sacrificale).

La saldatura interna di dimensioni ridotte e l'assenza di asperità taglienti consentono un perfetto scorrimento dei cavi senza rischio di danneggiamento del rivestimento. Continuità elettrica e tenuta stagna del sistema sono garantite utilizzando i raccordi DKC Cosmec (le approvazioni infatti si riferiscono al sistema chiuso, certificando la conformità dell'insieme tubi-raccordi). Offrono una buona protezione dalle interferenze elettromagnetiche su un'ampia banda di frequenze.

Lunghezze

- 3000mm (0 / +5mm)
- 4000mm (0 / -50mm)

- Standard **CEI EN 61386-1, 61386-21, CEI EN 60423**
- Classificazione CEI EN 61386 **5 5 5 5**
- Grado IP CEI EN 60529 **IP66/IP68/IP69**
- Resistenza alla compressione **4000 N**
- Resistenza all'urto **20 J**
- Resistenza alla trazione **1000 N**
- Resistenza al carico sospeso **450 N**
- Resistenza alla corrosione ISO 9227 **735ore**
- Classificazione ISO 12944 **Classe C3-Very High (VH)**
- Schermatura EMC secondo IEC TS 61587: 30-230MHz **Livello 2 (Abbattimento min. 50dB)**

3 Metri 3 Meters

CODICE CODE	DIAM. NOMINALE NOMINAL DIAM.	SPESORE THICKNESS	CONFEZIONE PACKAGE
	Ød mm	S mm	mt
6008-16L3	16	1	45
6008-20L3	20	1	45
6008-25L3	25	1,2	30
6008-32L3	32	1,2	24
6008-40L3	40	1,2	15
6008-50L3	50	1,2	15
6008-63L3	63	1,5	9
6008-75L3*	75	1,5	3

Non-threadable conduits, suitable for cold bending even in versions with reduced radius (2.5-3 times the Ø of the conduit). Made of hot-dip galvanized sheet for continuous immersion (UNI EN 10346: 2009) with zinc coating on the weld.

The new ZL coating forms a barrier against oxidizing agents for steel, not only in the coated surfaces but also in proximity of the edges of cut (sacrificial protection).

The internal welding with reduced dimensions and the absence of cutting roughness allows a perfect sliding of the cables without risk of covering damages. The electrical continuity and air/water-tight seal of the system is guaranteed through the use of the DKC's Cosmec fittings (all approvals relate to the closed system to certify the conformity of the conduit/fitting as a whole).

They offer good protection from electromagnetic interferences over a wide band of frequencies.

Lengths

- 3000mm (0 / +5mm)
- 4000mm (0 / -50mm)

- Standard **IEC EN 61386-1, 61386-21 and IEC EN 60423**
- Classification IEC EN 61386 **5 5 5 5**
- IP degree IEC EN 60529 **IP66/IP68/IP69**
- Compressive strength **4000 N**
- Impact resistance **20 J**
- Tensile strength **1000 N**
- Resistance to suspended load **450 N**
- Corrosion resistance ISO 9227 **735hours**
- Classification ISO 12944 **Class C3-Very High (VH)**
- EMC Shielding according to IEC TS 61587: 30-230MHz **Level 2 (Minimum abatement of 50dB)**

4 Metri 4 Meters

CODICE CODE	DIAM. NOMINALE NOMINAL DIAM.	SPESORE THICKNESS	CONFEZIONE PACKAGE
	Ød mm	S mm	mt.
6008-16L4	16	1	60
6008-20L4	20	1	40
6008-25L4	25	1,2	40
6008-32L4	32	1,2	20
6008-40L4	40	1,2	20
6008-50L4	50	1,2	16
-	63	1,5	-
-	75	1,5	-

*Prodotti privi di certificazioni
* Products without certifications

Accessori correlati Related accessories



6110	6111	6112	6117	6111P
pag. 82	pag. 82	pag. 83	pag. 84	pag. 85

■ Tubo rigido Rigid conduit



Rivestimento ZL
Maggiore resistenza rispetto ai tradizionali tubi metallici zincati
ZL coating
Greater resistance compared to traditional galvanized metal conduits

In acciaio zincato filettabili **6008-P** Threadable galvanised steel **6008-P**

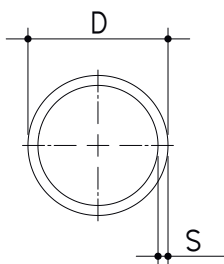

-60°C +150°C

Certificato IMQ
Certificate IMQ

-60°C +400°C

**IP66
IP68
IP69**

CEI EN 61386



CEI EN 61386



IEC TS 61587



Tubi filettabili, ideati per la curvatura a freddo anche in esecuzioni con raggi ridotti (2,5-3 volte il Ø del tubo).

Ricavati da lamiera zincata a caldo per immersione in continuo (UNI EN 10346:2009) con riporto di zinco sulla saldatura.

Il nuovo rivestimento ZL costituisce una barriera contro gli agenti ossidanti non solo nelle superfici rivestite ma anche in prossimità dei bordi di taglio (protezione sacrificale).

La saldatura interna di dimensioni ridotte e l'assenza di asperità taglienti consentono un perfetto scorrimento dei cavi senza rischio di danneggiamento del rivestimento. Continuità elettrica e tenuta stagna del sistema sono garantite utilizzando i raccordi DKC Cosmec (le approvazioni infatti si riferiscono al sistema chiuso, certificando la conformità dell'assieme tubi-raccordi). Offrono una buona protezione dalle interferenze elettromagnetiche su un'ampia banda di frequenze.

Particolari filettabili esclusivamente con passo metrico ISO secondo le norme CEI EN 60423.

Lunghezze

- 3000mm (0 / +5mm)

- Standard **CEI EN 61386-1, 61386-21, CEI EN 60423**
- Classificazione CEI EN 61386 **5 5 5 5**
- Grado IP CEI EN 60529 **IP66/IP68/IP69**
- Resistenza alla compressione **4000 N**
- Resistenza all'urto **20 J**
- Resistenza alla trazione **1000 N**
- Resistenza al carico sospeso **450 N**
- Resistenza alla corrosione ISO 9227 **735ore**
- Classificazione ISO 12944 **Classe C3-Very High (VH)**
- Schermatura EMC secondo IEC TS 61587: 30-230MHz **Livello2 (Abbattimento min. 50dB)**

Threadable conduits, suitable for cold bending even in versions with reduced radius (2.5-3 times the Ø of the conduit).

Made of hot-dip galvanized sheet for continuous immersion (UNI EN 10346: 2009) with zinc coating on the weld.

The new ZL coating forms a barrier against oxidizing agents for steel, not only in the coated surfaces but also in proximity of the edges of cut (sacrificial protection).

The internal welding with reduced dimensions and the absence of cutting roughness allows a perfect sliding of the cables without risk of covering damages. The electrical continuity and air/water-tight seal of the system is guaranteed through the use of the DKC's Cosmec fittings (all approvals relate to the closed system to certify the conformity of the conduit/fitting as a whole).

They offer good protection from electromagnetic interferences over a wide band of frequencies.

Threaded parts exclusively with ISO metric pitch according to IEC EN 60423 standards.

Lengths

- 3000mm (0 / +5mm)

- Standard **IEC EN 61386-1, 61386-21 and IEC EN 60423**
- Classification IEC EN 61386 **5 5 5 5**
- IP degree IEC EN 60529 **IP66/IP68/IP69**
- Compressive strength **4000 N**
- Impact resistance **20 J**
- Tensile strength **1000 N**
- Resistance to suspended load **450 N**
- Corrosion resistance ISO 9227 **735 hours**
- Classification ISO 12944 **Class C3-Very High (VH)**
- EMC shielding according to IEC TS 61587: 30-230MHz **Level 2 (Minimum abatement of 50dB)**

3 Metri 3 Meters

CODICE CODE	DIAMETRO NOMINALE NOMINAL DIAMETER	SPESSORE THICKNESS	CONFEZIONE PACKAGE
	Ød mm	S mm	
6008-16P3	16	1,5	45
6008-20P3	20	1,5	30
6008-25P3	25	1,5	30
6008-32P3	32	1,5	21
6008-40P3	40	1,5	15
6008-50P3	50	1,5	12

Accessori correlati Related accessories



6003

pag. 89



6015

pag. 60



6110

pag. 82



6111

pag. 82



6112

pag. 83



6117

pag. 84



6111P

pag. 85

■ Tubo rigido Rigid conduit

In acciaio inox AISI 304 **6700**
AISI 304 stainless steel **6700**

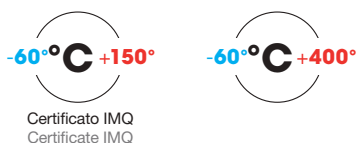
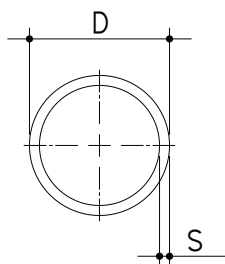

IP66
IP68
IP69

Tubi elettrocouplati ricavati da lamiera di acciaio INOX AISI 304 (X5CrNi1810 1.4301 UNI EN 10088-1) spazzolati uniformemente per una migliore finitura superficiale.

La saldatura interna scordonata consente un perfetto scorrimento dei cavi senza rischio di danneggiamento del rivestimento. Le dimensioni unificate consentono comunque l'utilizzo dei raccordi rapidi in ottone nichelato.

La continuità elettrica e la tenuta stagna del sistema sono garantite utilizzando i raccordi DKC Linea Cosmec (le approvazioni infatti si riferiscono al sistema chiuso, certificando la conformità dell'assieme tubi-raccordi).

Tubi non filettabili, ideali per la curvatura a freddo, anche in esecuzioni con raggi ridotti (2,5-3 volte il Ø del tubo).

Lunghezze

- 4000mm (0 / +20mm)

- Standard **CEI EN 61386-1, 61386-21 e CEI EN 60423**
- Classificazione CEI EN 61386 **5 5 5 5**
- Grado IP CEI EN 60529 **IP66/IP68/IP69**
- Resistenza alla compressione **4000 N**
- Resistenza alla trazione **1000 N**
- Resistenza al carico sospeso **450 N**
- Resistenza all'urto **20 J**
- Resistenza alla corrosione **4 Alta**
- Schermatura EMC IEC TS 61587: 30-230MHz **Livello1 (Abbattimento min. 35dB)**

Electro-coupled conduits made of AISI 304 stainless steel sheets (X5CrNi1810 1.4301 UNI EN 10088-1) uniformly brushed stainless steel, in order to obtain a good surface finishing.

The removed inner welding allows for perfect cable sliding without any coating damage risk.

The uniform dimensions allow however the use of normal nickel-plated brass quick fittings.

The electrical continuity and air/water-tight seal of the system are guaranteed through the use of the DKC Cosmec Line fittings (all approvals relate to the closed system to certify conformity of the conduit/fitting as a whole).

Non-threadable conduits, suitable for cold bending even in versions with reduced radius (2.5-3 times the Ø of the conduit).

Lenghts

- 4000mm (0 / +20mm)

- Standard **IEC EN 61386-1, 61386-21 and IEC EN 60423**
- Classification IEC EN 61386 **5 5 5 5**
- IP degree IEC EN 60529 **IP66/IP68/IP69**
- Compressive strength **4000 N**
- Tensile strength **1000 N**
- Resistance to suspended load **450 N**
- Impact resistance **20 J**
- Corrosion resistance **4 High**
- EMC Shielding IEC TS 61587: 30-230MHz **Level n.1 (Minimum abatement 35dB)**

4 Metri 4 Meters

CODICE CODE	DIAMETRO NOMINALE NOMINAL DIAMETER	SPESSORE THICKNESS	CONFEZIONE PACKAGE
	Ød mm	S mm	pz / pcs.
6700-16L4	16	1	40
6700-20L4	20	1	40
6700-25L4	25	1,2	40
6700-32L4	32	1,2	20
6700-40L4	40	1,2	20
6700-50L4	50	1,2	16
6700-63L4	63	1,5	9

CEI EN 61386	
CEI EN 61386	
IEC TS 61587	



Accessori correlati Related accessories



6110	6111	6112	6117	6111P
pag. 82	pag. 82	pag. 83	pag. 84	pag. 85

■ Tubo rigido Rigid conduit

In acciaio inox AISI 316L 6700A
AISI 316L stainless steel 6700A

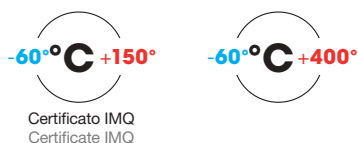
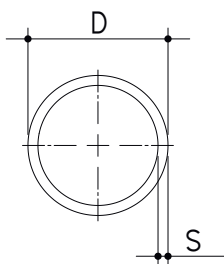

Certificato IMQ
Certificate IMQ

IP66
IP68
IP69

Tubi elettrocouplati ricavati da lamiera di acciaio AISI 316L (X2CrNiMo17-12-2 1.4404 UNI EN10088-1) spazzolati uniformemente per una migliore finitura superficiale. La saldatura interna scordonata consente un perfetto scorrimento dei cavi senza rischio di danneggiamento del rivestimento. Le dimensioni unificate consentono comunque l'utilizzo dei raccordi rapidi in ottone nichelato. La continuità elettrica e la tenuta stagna del sistema sono garantite utilizzando i raccordi DKC Cosmec (le approvazioni infatti si riferiscono al sistema chiuso, certificando la conformità dell'assieme tubi-raccordi).
Tubi non filettabili, ideali per la curvatura a freddo, anche in esecuzioni con raggi ridotti (2,5-3 volte il Ø del tubo).

Lunghezze

- 3000mm (0 / +10mm)

- Standard **CEI EN 61386-1, 61386-21 e CEI EN 60423**
- Classificazione CEI EN 61386-1 **5 5 5 5**
- Grado IP CEI EN 60529 **IP66/IP68/IP69**
- Resistenza alla compressione **4000 N**
- Resistenza alla trazione **1000 N**
- Resistenza al carico sospeso **450 N**
- Resistenza all'urto **20 J**
- Resistenza alla corrosione **4 Alta**
- Schermatura EMC IEC TS 61587: 30-230MHz **Livello1 (Abbattimento min. 35dB)**

Electro-coupled conduits made of AISI 316L steel sheets (X2CrNiMo17-12-2 1.4404 UNI EN10088-1) uniformly brushed, in order to obtain a good surface finishing. The removed inner welding allows for perfect cable sliding without any coating damage risk. The uniform dimensions allow however the use of normal nickel-plated brass quick fittings. The electrical continuity and air/water-tight seal of the system are guaranteed through the use of the DKC Cosmec fittings (all approvals relate to the closed system to certify conformity of the conduit/fitting as a whole).
Non-threadable conduits, suitable for cold bending even in versions with reduced radius (2.5-3 times the Ø of the conduit).

Lengths

- 3000mm (0 / +10mm)

- Standard **IEC EN 61386-1, 61386-21 and IEC EN 60423**
- Classification IEC EN 61386-1 **5 5 5 5**
- IP degree IEC EN 60529 **IP66/IP68/IP69**
- Compressive strength **4000 N**
- Tensile strength **1000 N**
- Resistance to suspended load **450 N**
- Resistance to impact **20 J**
- Corrosion resistance **4 High**
- EMC Shielding IEC TS 61587: 30-230MHz **Level 1 (Minimum abatement 35dB)**

3 Metri 3 Meters

CODICE CODE	DIAMETRO NOMINALE NOMINAL DIAMETER	SPESSORE THICKNESS	CONFEZIONE PACKAGE
	Ød mm	S mm	pz / pcs.
6700A16L3	16	1	45
6700A20L3	20	1	45
6700A25L3	25	1,2	30
6700A32L3	32	1,2	24
6700A40L3	40	1,2	15
6700A50L3	50	1,2	15
6700A63L3	63	1,5	9

CEI EN 61386	
CEI EN 61386	
IEC TS 61587	



Accessori correlati Related accessories



6110-XX

pag. 86



6111-XX

pag. 86



6112-XX

pag. 87



6117-XX

pag. 87

■ Raccordi a innesto rapido Quick coupling fittings

Caratteristiche raccordi per tubi metallici rigidi Fittings features for rigid metal conduits

- Standard **CEI EN 61386**
- Classificazione CEI EN 61386 **5 5 5 5**
- Grado IP CEI EN 60529 **IP66/IP68/IP69**
- Resistenza alla trazione **1000 N**
- Resistenza al carico sospeso **450 N**
- Resistenza alla corrosione **2 Media**
- Resistenza alla corrosione ISO 9227 **720 ore**

- Standard **IEC EN 61386**
- Classification IEC EN 61386 **5 5 5 5**
- IP degree IEC EN 60529 **IP66-IP68/69**
- Tensile strength **1000 N**
- Resistance to suspended load **450 N**
- Corrosion Resistance **2 Medium**
- Corrosion Resistance ISO 9227 **720 hours**



■ Raccordi a innesto rapido Quick coupling fittings

Caratteristiche raccordi per tubi metallici rigidi Fittings features for rigid metal conduits



IP66
IP68
IP69



Sono realizzati in ottone nichelato. Prodotti certificati, sottoposti ai controlli dei Marchi di Qualità IMQ e VDE. Il collegamento raccordo-tubo rigido avviene mediante un dispositivo brevettato, composto da un sistema di sfere in acciaio che, sfruttando la forma troncoconica interna del corpo raccordo, il tubo blocca assicurando un'elevata resistenza alla trazione e garantendo una continuità elettrica nel rispetto delle norme CEI EN 61386. La continuità elettrica è garantita nel tempo in quanto le sfere non scalfiscono la zincatura del tubo e quindi non creano zone di possibile ossidazione.

Filettature

- Metrica ISO CEI EN 60423 (in conformità alle CEI EN 61386)
- GAS cilindrico UNI ISO 228.

Made of nickel-plated brass. Certified products, subject to IMQ and VDE quality controls. The connection fitting-rigid tube takes place by means of a patented device consisting of a system of steel spheres that, exploiting the truncated conical shape of the inside of the connector, locks the conduit once it has been inserted, ensuring increased levels of tensile strength and guaranteeing electrical continuity in compliance with IEC EN 61386 Standard. Electrical continuity is guaranteed in time because the spheres do not scratch the galvanization on the conduit, and therefore do not create possible areas of oxidation.

Threads

- ISO Metric IEC EN 60423 (in accordance with CEI EN 61386)
- UNI ISO 228 GAS Cylindrical

Sistema di bloccaggio Locking system

- Il sistema di bloccaggio rapido permette con un semplice movimento di fissare il tubo nell'accessorio
- La molla conferisce una pressione sulle sfere d'acciaio che permette il bloccaggio del tubo assicurando una elevata resistenza alla trazione e garantendo una continuità elettrica nel rispetto della norma CEI EN 61386
- Non necessita di filettatura
- Non è richiesto l'uso di attrezzature per l'installazione
- Non necessita di saldatura
- Per il disinserimento è sufficiente premere assialmente l'anello ed estrarre il tubo;
- La facilità di installazione di questi raccordi consente una notevole riduzione dei tempi di montaggio

- The quick locking system allows to fix with a simple movement the conduit in the accessory
- The spring puts a pressure on the steel spheres which allows to lock the conduit providing high tensile strength and electrical continuity in compliance with IEC EN 61386
- No need of threads
- Installation does not require tools
- No need of welding
- To deactivate, simply press axially the ring and extract the conduit;
- Ease of installation of these fittings, allows to reduce the installation time considerably

Istruzioni di montaggio Installation instruction

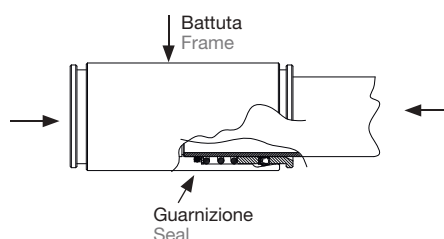
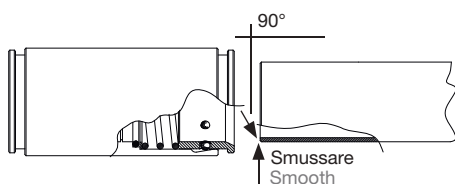

Per il corretto innesto spingere il tubo in battuta vincendo l'attrito della guarnizione con una leggera rotazione
For the correct fitting push the conduit in abutment against the friction of the seal with a slight rotation

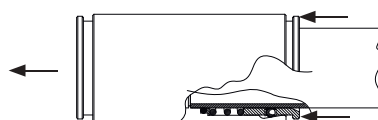

Per il disinserimento premere assialmente l'anello ed estrarre il tubo
For disengagement press axially the ring and extract the conduit

La guarnizione di tenuta garantisce un elevato grado di protezione IP (**IP66/IP68/IP69**). Per una tenuta garantita è sufficiente seguire alcune semplici regole:

- il tubo deve essere tagliato ad angolo retto e sbavato per evitare di danneggiare la guarnizione e il cavo
- il tubo deve essere spinto in battuta vincendo l'attrito della guarnizione con una leggera rotazione

The seal ensures a high IP protection degree IP (**IP66/IP68/IP69**). To achieve a tight sealing just follow some simple rules:

- the conduit must be cut square and deburred to prevent damage of the seal and to the cable
- the conduit must be pushed in abutment against the friction of the seal with a slight rotation

Raccordi a innesto rapido Quick coupling fittings

Tubo-tubo in ottone nichelato 6110 Nickel plated brass conduit-conduit 6110

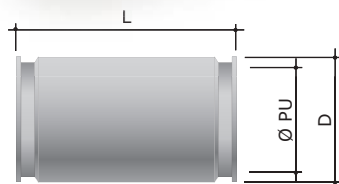

IP66
IP68
IP69

CEI EN 61386



CEI EN 61386



CEI EN 61386



CODICE CODE	DIAMETRO NOMINALE NOMINAL DIAMETER	DIMENSIONI mm DIMENSIONS mm			CONFEZIONE PACKAGE
	Ød mm	ØPU	L	D	pz / pcs.
6110-16N	16	15	58	23	8
6110-20N	20	19	58	27	8
6110-25N	25	24	58	32	5
6110-32N	32	31	63	39	4
6110-40	40	38	80	50	5
6110-50	50	48	80	60	5
6110-63N	63	61	84	75	1
6110-75*	75	73	122	86	1

* Soluzione con sistema di bloccaggio a vite SENZA CERTIFICAZIONI
* Solution with screw locking system WITHOUT CERTIFICATIONS

Tubo-scatoia in ottone nichelato 6111 Nickel plated brass conduit-box 6111

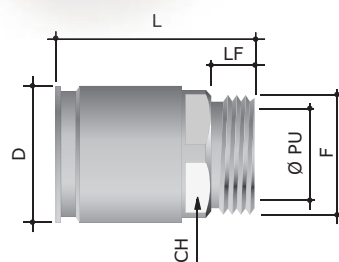

IP66
IP68
IP69

Filettatura metrica Metric thread

CEI EN 61386



CEI EN 61386



CEI EN 61386



Filettatura Metrica Metric thread

CODICE CODE	DIAMETRO NOMINALE NOMINAL DIAMETER	F	ØPU	DIMENSIONI mm DIMENSIONS mm			L	D	CONFEZIONE PACKAGE
	Ød mm			CH	LF	pz / pcs.			
6111-A16N	16	M16x1,5	12,7	20	10	41	23	8	
6111-A20N	20	M20x1,5	16,0	24	10	41	27	8	
6111-A25N	25	M25x1,5	21,0	29	10	41	32	5	
6111-A32N	32	M32x1,5	27,5	37	12	46	39	4	
6111-A40	40	M40x1,5	35,0	46	14	57	50	5	
6111-A50	50	M50x1,5	45,0	55	14	57	60	5	
6111-A63N	63	M63x1,5	55,0	75	14	68	75	1	
6111-A75*	75	M75x1,5	68,0	Ø86	20	84	86	1	

* Soluzione con sistema di bloccaggio a vite SENZA CERTIFICAZIONI
* Solution with screw locking system WITHOUT CERTIFICATIONS

Filettatura Gas ISO 228 Gas ISO 228 thread

CODICE CODE	DIAMETRO NOMINALE NOMINAL DIAMETER	F	ØPU	DIMENSIONI mm DIMENSIONS mm			L	D	CONFEZIONE PACKAGE
	Ød mm			CH	LF	pz / pcs.			
6111-16N	16	3/8"	12,7	20	10	41	23	8	
6111-20N	20	1/2"	16,0	24	10	41	27	8	
6111-25N	25	3/4"	21,0	29	10	41	32	5	
6111-32N	32	1"	27,5	37	12	46	39	4	
6111-40	40	1" 1/4	36,0	46	14	57	50	5	
6111-50	50	1" 1/2	42,0	55	14	57	60	5	

■ Raccordi a innesto rapido Quick coupling fittings

Tubo - filetto femmina in ottone nichelato **6112** Conduit-female thread fittings in nickel plated brass **6112**

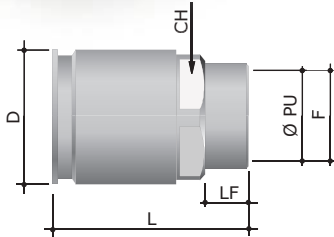

Filettatura Metrica Metric thread

CODICE CODE	DIAMETRO NOMINALE NOMINAL DIAMETER Ød mm	F	DIMENSIONI mm DIMENSIONS mm					D	CONFEZIONE PACKAGE pz / pcs.
			ØPU	CH	LF	L			
6112-A16	16	M16x1,5	14,5	20	10	39	23	8	
6112-A20	20	M20x1,5	18,5	24	10	39	27	8	
6112-A25	25	M25x1,5	23,5	29	10	39	32	5	
6112-A32	32	M32x1,5	30,5	37	12	44	39	4	
6112-A40	40	M40x1,5	38,5	46	15	58	50	5	
6112-A50	50	M50x1,5	48,5	55	15	58	60	5	
6112-A63N	63	M63x1,5	60,0	Ø75	21,5	67	75	1	

Filettatura Gas ISO 228 Gas ISO 228 thread

CODICE CODE	DIAMETRO NOMINALE NOMINAL DIAMETER Ød mm	F	DIMENSIONI mm DIMENSIONS mm					D	CONFEZIONE PACKAGE pz / pcs.
			ØPU	CH	LF	L			
6112-16N	16	3/8"	15,0	20	12	41	23	8	
6112-20N	20	1/2"	18,9	24	12	41	27	8	
6112-25N	25	3/4"	24,5	29	12	41	32	5	
6112-32N	32	1"	31,0	37	12	46	39	4	
6112-40	40	1" 1/4	38,0	46	15	58	50	5	
6112-50	50	1" 1/2	45,1	55	15	58	60	5	



IP66
IP68
IP69

Filettatura Metrica Metric thread

CEI EN 61386



CEI EN 61386



■ Raccordi a innesto rapido Quick coupling fittings

Tubo rigido - tubo flessibile in ottone nichelato **6117**

Rigid conduit-flexible conduits fittings in nickel plated brass **6117**

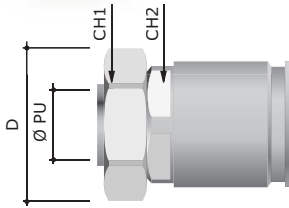

**IP66
IP68
IP69**

CEI EN 61386



CEI EN 61386



CODICE CODE	TUBO CONDUIT	TUBO FLESSIBILE FLEXIBLE CONDUIT	ØPU	DIMENSIONI mm DIMENSIONS mm			CONFEZIONE PACKAGE pz / pcs.
	ØD mm	Ød mm		CH	CH2	D	
6117-10N	16	10	8,5	24	24	27	25
6117-12N	16	12	10,0	26	24	29	25
6117-16N	16	16	13,8	30	28	33	25
6117-20N	20	16	13,8	30	28	33	25
6117-2020	20	21	18,0	37	35	40	15
6117-25N	25	21	18,0	37	35	40	15
6117-2527	25	27	23,0	45	42	50	10
6117-32N	32	27	24,0	45	42	50	10
6117-3235	32	35	30,0	52	50	55	5
6117-40	40	40	38,0	61	58	64	5
6117-4035	40	35	32,0	52	58	55	5
6117-5040	50	40	38,0	61	58	64	5
6117-50	50	51	48,0	74	70	78	5
6117-63N	63	51	48,0	74	Ø75	78	1
6117-75*	75	63	59,5	94	94	100	1

* Soluzione con sistema di bloccaggio a vite **SENZA CERTIFICAZIONI**
* Solution with screw locking system **WITHOUT CERTIFICATIONS**

■ Raccordi a innesto rapido Quick coupling fittings

Pressacavo per tubi metallici rigidi **6111P** Cable gland for rigid metal conduits **6111P**

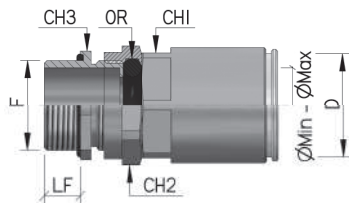

**IP66
IP68**

Particolari realizzati in ottone nichelato.
Le caratteristiche di funzionamento sono identiche a quelle dei raccordi cod.6110-6111; questi particolari raccordi includono un adattatore pressacavo con terminale filettato maschio.
Sono prodotti con filettatura METRICA ISO in conformità alle norme CEI EN 60423.
Questi accessori sono utilizzati quando è necessario rendere stagna una parte dell'impianto.

- Standard
CEI EN 61386 e CEI EN 62444
- Grado IP EN 60529 **IP66/IP68**

Made of nickel plated brass.
The operating characteristics are identical to those of the fittings code 6110-6111; these special fittings include a cable gland adapter with a metric male threaded heads.
The thread is ISO Metric and complies with IEC EN 60423.

These accessories are designed for use when it becomes necessary to give water-tightness to the system.

- Standard
IEC EN 61386 and IEC EN 62444
- IP degree EN 60529 **IP66/IP68**

Filettatura Metrica Metric thread

CODICE CODE	DIAMETRO NOMINALE NOMINAL DIAMETER ØD mm	SERRAGGIO TIGHTENING ØMin ØMax	DIMENSIONI mm DIMENSIONS mm				LF	CONFEZIONE PACKAGE pz / pcs.
			F	CH1	CH2	CH3		
6111P16M120509	16	05 ÷ 09	M 12x1,5	20	20	20	10	30
6111P16M160509	16	05 ÷ 09	M 16x1,5	20	20	20	10	30
6111P16M200812	16	08 ÷ 12	M 20x1,5	20	24	24	10	30
6111P20M160812	20	08 ÷ 12	M 16x1,5	24	24	24	10	30
6111P20M200812	20	08 ÷ 12	M 20x1,5	24	24	24	10	30
6111P20M251116	20	11 ÷ 16	M 25x1,5	24	30	30	10	30
6111P25M201116	25	11 ÷ 16	M 20x1,5	29	30	30	10	20
6111P25M251116	25	11 ÷ 16	M 25x1,5	29	30	20	10	20
6111P25M321521	25	15 ÷ 21	M 32x1,5	29	36	36	10	20
6111P32M251521	32	15 ÷ 21	M 25x1,5	37	36	36	10	10
6111P32M321521	32	15 ÷ 21	M 32x1,5	37	36	36	10	10
6111P32M402027	32	20 ÷ 27	M 40x1,5	37	45	45	10	10
6111P40M322027	40	20 ÷ 27	M 32x1,5	46	45	45	10	5
6111P40M402027	40	20 ÷ 27	M 40x1,5	46	45	45	10	5

■ Raccordi a innesto rapido in acciaio inox AISI 316L

AISI 316L stainless steel quick coupling fittings

In acciaio inox AISI 316L
AISI 316L stainless steel

Prodotti in acciaio inox AISI 316L per essere utilizzati nei luoghi in cui i raccordi tradizionali in ottone nichelato non sono ritenuti sufficientemente resistenti alle condizioni ambientali.

Made in AISI 316L stainless steel, to be used in situations where traditional nickel plated brass fittings are considered to be insufficiently resistant to the environmental conditions.

- Standard **CEI EN 61386**
- Classificazione CEI EN 61386 **5 5 5 5**
- Grado IP CEI EN 60529 **IP66/IP68/IP69**
- Resistenza alla trazione **1000 N**
- Resistenza al carico sospeso **450 N**
- Resistenza alla corrosione **4 Alta**

- Standard **IEC EN 61386**
- Classification IEC EN 61386 **5 5 5 5**
- IP degree IEC EN 60529 **IP66/IP68/IP69**
- Tensile strength **1000 N**
- Resistance to suspended load **450 N**
- Corrosion resistance **4 High**

Tubo - Tubo 6110-XX

Conduit - Conduit 6110-XX

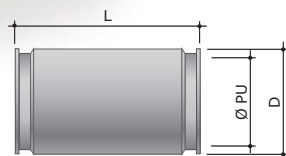

IP66
IP68
IP69

CEI EN 61386



CEI EN 61386



CODICE CODE	DIAMETRO NOMINALE NOMINAL DIAMETER	ØPU	DIMENSIONI mm DIMENSIONS mm		CONFEZIONE PACKAGE pz / pcs.
	ØD mm		L	D	
6110-16XX	16	15	64	24	8
6110-20XX	20	19	64	28	8
6110-25XX	25	24	64	32	5
6110-32XX	32	31	66	40	4
6110-40XX	40	38	83	50	5
6110-50XX	50	48	83	60	5
6110-63XX	63	61	89	Ø74,5	1

Tubo - Scatola 6111-XX

Conduit - Box 6111-XX

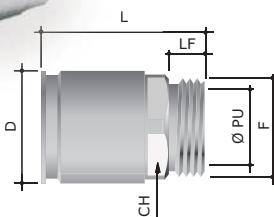

IP66
IP68
IP69

CEI EN 61386



CEI EN 61386



Filettatura Metrica Metric thread

CODICE CODE	DIAMETRO NOMINALE NOMINAL DIAMETER	F	ØPU	DIMENSIONI mm DIMENSIONS mm			D	CONFEZIONE PACKAGE pz / pcs.
	Ød mm			CH	LF	L		
6111-16XX	16	M16x1,5	12,7	21	10	45	24	8
6111-20XX	20	M20x1,5	16,0	25	10	45,5	28	8
6111-25XX	25	M25x1,5	21,0	30	10	46,5	32	5
6111-32XX	32	M32x1,5	27,5	37	12	49,5	40	4
6111-40XX	40	M40x1,5	35,0	47	14	52	50	5
6111-50XX	50	M50x1,5	45,0	56	14	57	60	5
6111-63XX	63	M63x1,5	55	Ø74,5	14	65,5	74,5	1

■ Raccordi a innesto rapido in acciaio inox AISI 316L AISI 316L stainless steel quick coupling fittings

Tubo - Filetto femmina 6112-XX

Conduit - Female thread 6112-XX

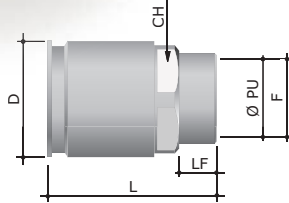

Filettatura Metrica Metric thread

CODICE CODE	DIAMETRO NOMINALE NOMINAL DIAMETER		DIMENSIONI mm DIMENSIONS mm					CONFEZIONE PACKAGE
	ØD mm	F	ØPU	CH	LF	D	L	pz / pcs.
6112-16XX	16	M16x1,5	14,5	21	10	24	43	8
6112-20XX	20	M20x1,5	18,5	25	10	28	43	8
6112-25XX	25	M25x1,5	23,5	30	10	32	43	5
6112-32XX	32	M32x1,5	30,5	37	12	39	46	4
6112-40XX	40	M40x1,5	38,5	47	15	50	58,5	5
6112-50XX	50	M50x1,5	48,5	56	15	60	58,5	5
6112-63XX	63	M63x1,5	57	Ø74,5	21,5	75	71,5	1



IP66
IP68
IP69

CEI EN 61386



CEI EN 61386



Tubo rigido - Tubo flessibile 6117-XX

Rigid Conduit - Flexible conduit 6117-XX

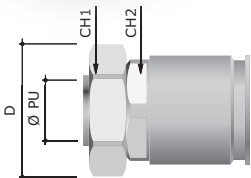

CODICE CODE	DIAMETRO NOMINALE NOMINAL DIAMETER	TUBO FLESSIBILE FLEXIBLE CONDUIT	DIMENSIONI mm DIMENSIONS mm				CONFEZIONE PACKAGE
	Ød mm		ØPU	CH1	CH2	D	pz / pcs.
6117XX20N	20	16	13,8	30	30	33	25
6117XX25N	25	21	18,0	36	36	40	15
6117XX32N	32	27	24,0	46	46	50	10
6117XX4035	40	35	32,0	55	50	55	5
6117XX5040	50	40	38,0	60	60	64	5
6117XX63N	63	51	48	74	Ø74,5	75	1



IP66
IP68
IP69

CEI EN 61386



CEI EN 61386



Accessori Accessories

Curve a 90° non filettabili 6013 Non-threadable 90° elbows 6013

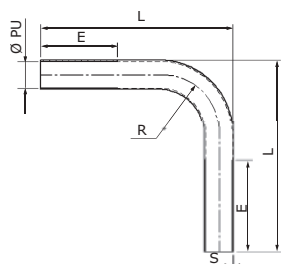

La particolare cura nella finitura degli imbocchi, assicura un perfetto infilaggio dei cavi senza rischio di danneggiamento del rivestimento. Normalmente sono utilizzate quando le esigenze di installazione non consentono la curvatura del tubo in opera. Continuità elettrica garantita

The particular care in the finishing of the inlets, ensures a perfect threading of cables without risk of damage to the coating. They are normally used when the installation requirements do not allow bending the conduit on site. Electrical continuity guaranteed

- Standard CEI EN 61386 e 61386-21
- Grado IP del sistema IP66/IP68/IP69

- Standards IEC EN61386-1 and 61386-21
- System protection degree IP66/IP68/IP69

Acciaio zincato Galvanized steel

CODICE CODE	DIAMETRO NOMINALE NOMINAL DIAMETER	S	DIMENSIONI mm DIMENSIONS mm				CONFEZIONE PACKAGE
	ØD mm		Ø PU	E	R	L	pz / pcs.
6013-16L	16	1,0	14,0	100	40,0	150	5
6013-20L	20	1,0	18,0	100	50,0	155	5
6013-25L	25	1,2	22,5	100	62,5	180	5
6013-32L	32	1,2	29,5	100	80,0	200	5
6013-40	40	1,2	37,5	100	100,0	240	5
6013-50	50	1,2	47,5	170	170,0	370	1
6013-63	63	1,5	60,0	200	230,0	460	1

Acciaio Inox Stainless steel

AISI 304 CODICE CODE	AISI 316L CODICE CODE	DIAMETRO NOMINALE NOMINAL DIAMETER	S	DIMENSIONI mm DIMENSIONS mm				CONFEZIONE PACKAGE
		ØD mm		Ø PU	E	R	L	pz / pcs.
6013-16X	-	16	1,0	14,0	100	46,0	155	5
6013-20X	6013-20XX	20	1,0	18,0	110	67,0	195	5
6013-25X	6013-25XX	25	1,2	22,5	125	82,0	225	5
6013-32X	6013-32XX	32	1,2	29,5	150	112,0	285	5
6013-40X	6013-40XX	40	1,2	37,5	150	190,0	360	5
6013-50X	6013-50XX	50	1,2	47,5	175	250,0	450	1
6013-63X	6013-63XX	63	1,5	60				1

Testacanna 6097L Bushing 6097L

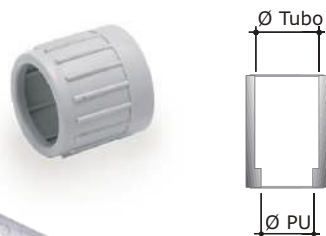

Sono prodotti in materiale plastico PE-LD privo di alogeni e sono applicati alle estremità dei tubi metallici per evitare il contatto diretto tra i cavi e gli spigoli del tubo durante le operazioni di infilaggio. Colore Grigio RAL 7035

Manufactured in halogen-free PE-LD plastic, applied to the end of the metal conduits to prevent direct contact between the cables and the corners of the conduit during insertion operations. Colour Grey RAL 7035

CODICE CODE	DIAMETRO NOMINALE NOMINAL DIAMETER	DIMENSIONI mm DIMENSIONS mm	CONFEZIONE PACKAGE
	ØD mm	Ø PU mm	pz / pcs.
6097L16B	16	14,0	100
6097L20B	20	18,0	100
6097L25B	25	22,5	100
6097L32B	32	29,5	50
6097L40B	40	37,5	50
6097L50B	50	47,5	25
6097L63B	63	60,0	20

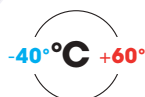

Accessori Accessories

Manicotti filettati 6003 Threaded couplings 6003

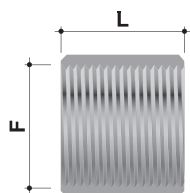

IP66

CEI EN 61386



CEI EN 61386



Sono prodotti in ottone nichelato. Questi raccordi permettono la giunzione tra due filetti maschi uguali. Continuità elettrica garantita. Filettatura Metrica ISO in conformità con le norme CEI EN 60423.

- Standard **CEI EN 61386**
- Grado di protezione del sistema **IP66**

Made of nickel-plated brass. These fittings allow the junction between two equal male threads. Electrical continuity guaranteed. ISO Metric thread in accordance with the standards IEC EN 60423.

- Standard **IEC EN 61386**
- System protection **IP66**

Filettatura Metrica Metric thread

CODICE CODE	DIAMETRO NOMINALE NOMINAL DIAMETER ØD mm	DIMENSIONI mm DIMENSIONS mm		CONFEZIONE PACKAGE pz / pcs.
		F	L	
6003-16A	16	M16x1,5	27	100
6003-20	20	M20x1,5	30	100
6003-25	25	M25x1,5	36	50
6003-32A	32	M32x1,5	40	25
6003-40	40	M40x1,5	40	20
6003-50	50	M50x1,5	50	5
6003-63*	63	M63x1,5	65	2

* Senza certificazioni
* Without certifications

Adattatori 6052 Adapters 6052

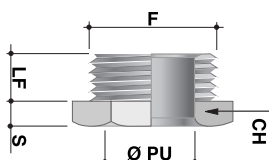

Sezione Montaggio Mounting section

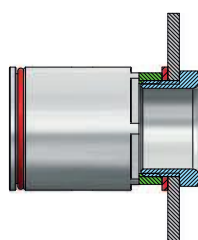

Sono prodotti in ottone nichelato. Questi raccordi terminali, internamente lisci e con imbocco raggato, sono utilizzati per derivarsi da scatole senza attacchi o da canaline metalliche allo scopo di ridurre l'ingombro interno. Il loro impiego implica l'utilizzo di raccordi filetto femmina montati dalla parte del tubo e facilitano l'eventuale smontaggio della connessione tubo-scatoia ad impianto già fissato. Filettatura Metrica ISO conforme alle norme CEI EN 60423. Continuità elettrica garantita.

- Standard **CEI EN 61386**

Made of nickel-plated brass. These end fittings, internally smooth and with radius inlet, are used for connections from boxes without connectors or from metal channels in order to reduce the internal encumbrance. Their use involves the use of female thread fittings mounted on the conduit side and facilitate the removal of the connection tube-box when the system has already been fixed. ISO Metric Thread compliant to IEC EN 60423 standards. Electrical continuity guaranteed.

- Standard **IEC EN 61386**

Filettatura Metrica Metric thread

CODICE CODE	F	Ø PU	DIMENSIONI mm DIMENSIONS mm			CONFEZIONE PACKAGE pz / pcs.
			CH	LF	S	
6052-16A	M16x1,5	13	22	10	3,0	20
6052-20	M20x1,5	15	26	10	3,0	20
6052-25	M25x1,5	21	30	12	3,5	20
6052-32A	M32x1,5	28	40	12	4,0	10
6052-40	M40x1,5	35	50	14	4,0	10
6052-50	M50x1,5	44	58	18	5,0	5

■ Collare fissatubo Conduit clamp collar

UNIKO



UNIKO il nuovo collare DKC a bloccaggio rapido adatto per tutta la serie di tubi rigidi, con sistema di fissaggio del coperchio a scatto ed ancorato alla base.

L'assenza di viti permette l'installazione ed il fissaggio del tubo senza l'ausilio di utensili, riducendo drasticamente i tempi di montaggio.

La base presenta un'asola per il fissaggio da 6 x 10, tutti i bordi sono privi di bave. Disponibili nella versione in acciaio FE60 rilaminato e successivamente zincati elettroliticamente, in acciaio inox AISI304 e su richiesta in acciaio AISI316L.

Ogni singolo pezzo riporta la marcatura del diametro del tubo.

UNIKO the new DKC quick-locking collar suitable for the whole series of rigid conduit, with a snap-on lid fixing system and anchored to the base.

The absence of screws allows the installation and fixing of the conduit without the aid of tools, drastically reducing assembly times.

The base has a slot for 6 x 10 fixing, all edges are free of burrs.

Available in the re-rolled FE60 steel version and subsequently electrolytically galvanized, in AISI304 stainless steel and on request in AISI 316L stainless steel.

Each piece shows the marking of the tube diameter.

Materiali

Realizzati in:

- Acciaio zincato
- Acciaio Inox AISI304
- Acciaio Inox AISI316L a richiesta

Materials

Made in:

- Galvanized steel
- AISI304 stainless steel
- AISI316L stainless steel on request

Sistema Brevettato

Patented System

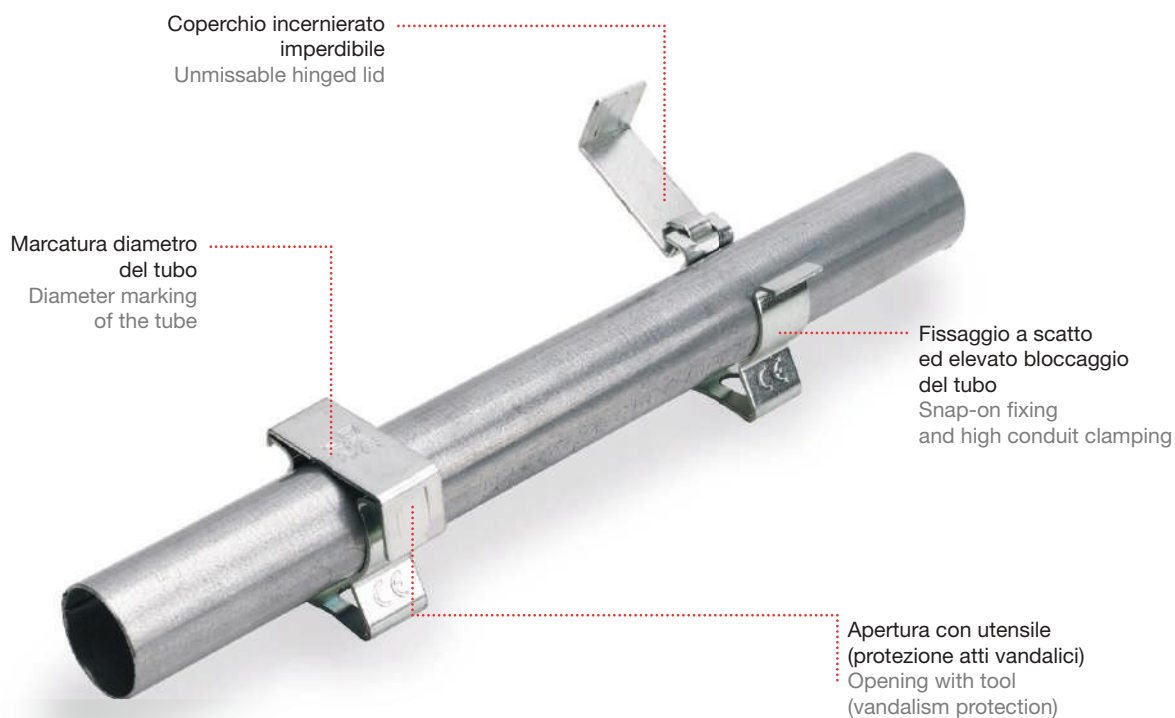

■ Collare fissatubo Conduit clamp collar

UNIKO

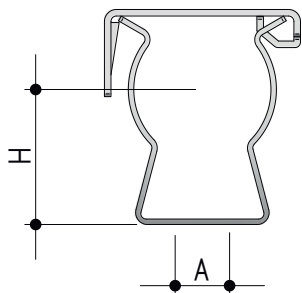

Acciaio Zincato Galvanized steel

CODICE CODE	DIAMETRO DIAMETER ØD mm	DIMENSIONE DIMENSIONS		CONFEZIONE PACKAGE pz / pcs.
		H	A	
UNIKO16	16	20	6,5x10	125
UNIKO20	20	21,5	6,5x10	100
UNIKO25	25	25	6,5x10	75
UNIKO32	32	27	6,5x10	60
UNIKO40	40	32	6,5x10	40
UNIKO50	50	40	6,5x10	30

Acciaio Inox AISI 304 AISI 304 Stainless steel

CODICE CODE	DIAMETRO DIAMETER ØD mm	DIMENSIONE DIMENSIONS		CONFEZIONE PACKAGE pz / pcs.
		H	A	
UNIKO16X	16	20	6,5x10	125
UNIKO20X	20	21,5	6,5x10	100
UNIKO25X	25	25	6,5x10	75
UNIKO32X	32	27	6,5x10	60
UNIKO40X	40	32	6,5x10	50
UNIKO50X	50	40	6,5x10	30

Acciaio Inox AISI 316L AISI 316L Stainless steel

CODICE CODE	DIAMETRO DIAMETER ØD mm	DIMENSIONE DIMENSIONS		CONFEZIONE PACKAGE pz / pcs.
		H	F	
UNIKO16XX*	16	20	6,5x10	125
UNIKO20XX*	20	21,5	6,5x10	100
UNIKO25XX*	25	25	6,5x10	75
UNIKO32XX*	32	27	6,5x10	60
UNIKO40XX*	40	32	6,5x10	50
UNIKO50XX*	50	40	6,5x10	30

*A richiesta / On request

■ Collare fissatubo Conduit clamp collar

Speedy Fix 6044

Speedy Fix 6044



Sono composti da un supporto sagomato e da una clips di sicurezza antistrappo che assicura il bloccaggio del tubo offrendo un'elevata resistenza ai carichi sospesi. I bordi privi di bave consentono l'installazione senza scalfire il tubo.

L'assenza di viti permette l'installazione ed il fissaggio del tubo senza l'ausilio di utensili, riducendone drasticamente i tempi di montaggio.

I collari in acciaio zincato sono prodotti da nastro di acciaio Fe60 rilaminato e successivamente zincati elettroliticamente.

I collari in acciaio inox sono prodotti da nastro in acciaio inox AISI 304 e a richiesta AISI 316L.

They are composed of a shaped support and a strain relief safety clips which ensures the locking of the tube by offering high resistance to suspended loads.

The edges free of burrs allow installation without scratching the tube.

The absence of screws allows installing and mounting the conduit without the aid of tools, drastically reducing assembly times.

The collars in galvanized steel are produced from re-rolled Fe60 steel strip and thereafter electrolytically plated or galvanized. The collars in stainless steel are produced from stainless steel AISI 304 and AISI 316L strip.

Acciaio zincato Galvanized steel

CODICE CODE	DIAMETRO NOMINALE NOMINAL DIAMETER ØD mm	DIMENSIONI, mm DIMENSIONS, mm		CONFEZIONE PACKAGE pz / pcs.
		H	A	
6044-A16	16	20,0	6x10mm	100
6044-A20	20	20,0	6x10mm	100
6044-A25	25	26,0	6x10mm	50
6044-A32	32	27,0	6x10mm	50
6044-A40	40	36,0	6x10mm	25
6044-A50	50	40,0	6x10mm	25

Sistema brevettato Patented system



Acciaio AISI 304 AISI 304 steel

CODICE CODE	DIAMETRO NOMINALE NOMINAL DIAMETER ØD mm	DIMENSIONI, mm DIMENSIONS, mm		CONFEZIONE PACKAGE pz / pcs.
		H	A	
6044-XA20	20	20,0	6x10mm	100
6044-XA25	25	26,0	6x10mm	50
6044-XA32	32	27,0	6x10mm	50

Acciaio AISI 316L AISI 316L steel

CODICE CODE	DIAMETRO NOMINALE NOMINAL DIAMETER ØD mm	DIMENSIONI, mm DIMENSIONS, mm		CONFEZIONE PACKAGE pz / pcs.
		H	A	
6044-XXA16*	16	20,0	6x10mm	100
6044-XXA20*	20	20,0	6x10mm	100
6044-XXA25*	25	26,0	6x10mm	50
6044-XXA32*	32	27,0	6x10mm	50
6044-XXA40*	40	36,0	6x10mm	25
6044-XXA50*	50	40,0	6x10mm	25

*A richiesta / On request

■ Collare fissatubo Conduit clamp collar

Collari fissatubo 6040 Conduit clamp collar 6040



Prodotti da nastro di acciaio inox e successivamente zincati elettrolitici o in acciaio inox AISI 304.

Sono composti da un supporto sagomato la cui base presenta un'asola atta a favorire l'allineamento, e da una mezzaluna che, tramite il serraggio di due viti, blocca il tubo da sorreggere.

Produced from steel strip and subsequently electrolytic galvanized or AISI 304 stainless steel.

They are composed of a shaped support whose base has a slot which is suitable to facilitate the alignment, and of a clamp that, by tightening the two screws, locks the conduit to be supported.

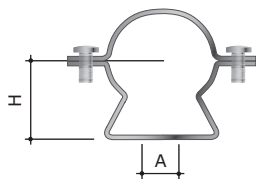

CODICE CODE Acciaio zincato Stainless steel	CODICE CODE AISI 304 AISI 304	TUBO CONDUIT Ø mm	SERRAGGIO TIGHTENING Ø mm	DIMENSIONI mm DIMENSIONS mm H A	CONFEZIONE PACKAGE pz / pcs.
6040-16	6040-X16	16	3/8"	16,0-19,5 20	6x10 125
6040-22	6040-X22	20	1/2"	20,0-23,5 22	6x10 100
6040-25	6040-X25	25	3/4"	23,5-26,0 25	6x10 75
6040-32	6040-X32	32	1"	26,5-33,0 32	6x12 60
6040-38	6040-X38	40	1"1/4	35,0-40,0 41	6x12 40
6040-50	6040-X50	50	1"1/2	43,0-50,0 45	8x14 30
6040-60	6040-X60	63	2"	54,0-63,0 53	8x14 20

Collari di messa a terra 6042 Earthing Collars 6042



Prodotti da nastro di acciaio e successivamente zincati elettrolitici.

Sono utilizzati per collegamenti equipotenziali fra tubi metallici, impiegando cavi fino a 16mm².

Produced from steel strip and subsequently electrolytically galvanized.

They are used for equipotential connections between metal conduits, using cables up to 16mm².

CODICE CODE	TUBO CONDUIT Ø mm	TUBO CONDUIT "	CONFEZIONE PACKAGE pz / pcs.
6042-16	16	3/8"	125
6042-20	20	1/2"	100
6042-25	25	3/4"	75
6042-32	32	1"	50
6042-40	40	1"1/4	40
6042-50	50	1"1/2	30
6042-63	63	2"	20

Barre per fissaggi multipli 6190 6191 Bars for multiple fastenings 6190 6191



6190



6191

Entrambi gli accessori sono utilizzati per allineare batterie di collari, facilitando il posizionamento dei tubi rigidi metallici. Le barre cod.6190 sono prodotte da nastro di acciaio profilato e successivamente zincate a caldo.

La lunghezza di una barra è 2m. I blocchetti cod.6191 sono stampati e zincati elettrolitici.

Both accessories are used to arrange the collars in array, facilitating the positioning of the rigid metal conduits.

The bars cod.6190 are produced from steel strip section and then hot-dip galvanized. The length of a bar is 2m.

The blocks cod.6191 are electrolytic galvanized.

CODICE CODE	DESCRIZIONE DESCRIPTION	CONFEZIONE PACKAGE
6190	Barre di fissaggio multipli Bars for multiple fastenings	20 mt
6191	Blocchetti di fissaggio M6 Fixing blocks M6	50 pz/pcs

■ Collare fissatubo Conduit clamp collar

Pesante in acciaio zincato con dado di fissaggio 6040-P Heavy in galvanized steel with fixing nut 6040-P



Prodotti da nastro di acciaio e successivamente zincati elettrolitici, viti di serraggio in acciaio zincato testa esagonale taglio combinato.

Sono composti da un supporto sagomato la cui base presenta un dado filettato elettrosaldato; la parte superiore è costituita da una mezzaluna che blocca il tubo da sorreggere.

Le buone caratteristiche meccaniche ne permettono l'impiego in situazioni gravose.

Produced from steel strip and subsequently electrolytically galvanized, tightening screws in galvanized steel hexagonal head combined cut.

They are composed of a shaped support whose base has a threaded nut welded; the upper part is constituted by a clamp that locks the conduit to be supported.

The good mechanical characteristics allow it to be used in heavy situations.

CODICE CODE	TUBO CONDUIT		SERRAGGIO TIGHTENING	INTERASSE BASE BASE AXIS DISTANCE	FILETTO THREAD	PIATTINA FLAT	CONFEZIONE PACKAGING
	ø mm	"					
6040-P12	20	1/2"	18-24	20	M8	20x2,5	100
6040-P34	25	3/4"	25-30	23	M8	20x2,5	100
6040-P01	32	1"	30-36	27	M8	20x2,5	100
6040-P114	40	1" 1/4	38-44	30	M8	20x2,5	100
6040-P112	50	1" 1/2	44-50	35	M8	20x2,5	100
6040-P02	63	2"	56-63	42	M8	20x2,5	100
6040-P212	75	2" 1/2	75-80	50	M10	30x2,5	100
6040-P03		3"	84-90	57	M10	30x2,5	100
6040-P04		4"	112-118	70	M10	30x2,5	100

Pesante in acciaio inox 304/316L con dado di fissaggio 6040 Heavy in stainless steel 304/316L with fixing nut 6040



Accessori prodotti da nastro in acciaio inox AISI304 (X5CrNi1810 1.4301 UNI EN 10088-1) o AISI 316 (X5CrNiMo17-12-2 1.4401 UNI EN 10088-1) successivamente lucidato. Sono composti da un supporto sagomato la cui base presenta un dado filettato e da una mezzaluna che blocca il tubo da sorreggere.

Le buone caratteristiche meccaniche ne permettono l'impiego in situazioni gravose.

Accessories made of stainless steel AISI304 (X5CrNi1810 1.4301 UNI EN 10088-1) or AISI 316 (X5CrNiMo17-12-2 1.4401 UNI EN 10088-1) strip subsequently polished. They are composed of a shaped support whose base has a threaded nut and a clamp that holds the conduit to be supported.

The good mechanical characteristics allow it to be used in heavy situations.

CODICE AISI 304 AISI 304 CODE	CODICE AISI 316L AISI 316L CODE	TUBO CONDUIT		SERRAGGIO TIGHTENING	FILETTO THREAD	PIATTINA STRAP	F Nm*	CONFEZIONE PACKAGING
		ø mm	"					
6040-038	-	16	3/8"	15-19	M 8	20x2	80	100
6040-012	6040-012X	20	1/2"	20-24	M 8	20x2	80	100
6040-034	6040-034X	25	3/4"	25-29	M 8	20x2	80	100
6040-001	6040-001X	32	1"	32-36	M 8	20x2	80	100
6040-114	6040-114X	40	1" 1/4	40-45	M 8	20x2,5	90	100
6040-112	6040-112X	50	1" 1/2	47-51	M 8	20x2,5	90	100
6040-002	-	63	2"	59-63	M 8	20x2,5	90	100
6040-212	-	75	2" 1/2	73-78	M 10	30x2,5	130	100
6040-003	-		3"	86-92	M 10	30x2,5	130	100
6040-004	-		4"	108-115	M 10	30x2,5	130	100

* Resistenza minima dei dadi elettrosaldati
* Minimum Resistance of electrically welded nuts

Pressacavo Cable gland

In ottone nichelato **6018**
Nickel plated brass **6018**



Prodotti in ottone nichelato, sono composti da un corpo al cui interno alloggia un gommino in neoprene che si deforma sotto l'azione di un dado di serraggio, garantendo una tenuta stagna IP54 ed una buona tenuta allo strappo.
Le guarnizioni sono resistenti all'invecchiamento, alla corrosione, agli oli e sono inerti nei confronti dei materiali che rivestono i cavi.

Made of nickel-plated brass, consists of a body, inside of which there is a neoprene rubber that deforms under the action of a tightening nut, ensuring a hermetic IP54 seal and a good tearing resistance.
The seals are resistant to ageing, corrosion, oils and, remain inert to the material that sheaths the cables.

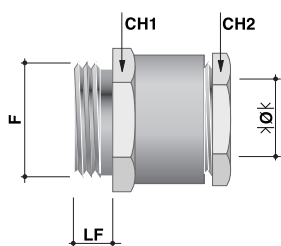

IP54

Filettatura Metrica Metric thread

Conforme alle norme CEI EN 62444
Complying with standards IEC EN 62444

CODICE CODE	SERRAGGIO CAVO CABLE TIGHTENING Ø Min - Ø Max	F	DIMENSIONI mm DIMENSIONS mm		LF	CONFEZIONE PACKAGE pz / pcs.
			CH1	CH2		
6018-12A	4 ÷ 6	M12x1,5	14	13	5,0	50
6018-16	8 ÷ 10	M16x1,5	17	15	6,0	10
6018-20	10 ÷ 12	M20x1,5	22	20	7,0	20
6018-25	17 ÷ 19	M25x1,5	30	28	8,5	20
6018-32	19 ÷ 22	M32x1,5	35	33	9,0	20
6018-40	26 ÷ 30	M40x1,5	45	42	10,2	25
6018-50	39 ÷ 41	M50x1,5	57	54	10,0	25
6018-63	43 ÷ 45	M63x1,5	64	60	12,0	20

Filettatura PG PG thread

CODICE CODE	SERRAGGIO CAVO CABLE TIGHTENING Ø Min - Ø Max	F	DIMENSIONI mm DIMENSIONS mm		LF	CONFEZIONE PACKAGE pz / pcs.
			CH1	CH2		
6018-07	5 ÷ 7	7	14	13	5,0	10
6018-09	6 ÷ 8	9	17	15	6,0	10
6018-11	8 ÷ 10	11	20	18	6,0	10
6018-13	10 ÷ 12	13,5	22	20	6,5	10
6018-15	12 ÷ 14	16	24	22	6,5	10
6018-21	15 ÷ 17	21	30	28	7,0	10
6018-29	24 ÷ 26	29	40	37	8,0	10
6018-36	31 ÷ 35	36	50	47	9,0	10
6018-42	39 ÷ 41	42	57	54	10,0	5
6018-48	43 ÷ 45	48	64	60	10,0	5

Filettatura GAS ISO 228 GAS ISO 228 thread

CODICE CODE	SERRAGGIO CAVO CABLE TIGHTENING Ø Min - Ø Max	F	DIMENSIONI mm DIMENSIONS mm		LF	CONFEZIONE PACKAGE pz / pcs.
			CH1	CH2		
6018-14	4 ÷ 6	1/4"	14	13	5,0	10
6018-38	8 ÷ 10	3/8"	17	15	6,0	10
6018-12	10 ÷ 12	1/2"	22	20	7,0	10
6018-34	17 ÷ 19	3/4"	30	28	8,5	10
6018-01	19 ÷ 22	1"	35	33	9,0	10
6018-114	26 ÷ 30	1" 1/4	45	42	10,2	10
6018-112	33 ÷ 35	1" 1/2	50	47	12,0	10
6018-02	43 ÷ 45	2"	64	60	12,0	5

■ Pressacavo Cable gland

In ottone nichelato **6018-M** Nickel plated brass **6018-M**



Sono prodotti in ottone nichelato. Il serraggio del dado provoca la deformazione della guarnizione che, oltre a garantire una tenuta stagna IP68 a 5 bar di pressione, assicura una eccezionale tenuta allo strappo. Un'ulteriore guarnizione o-ring alloggiata in apposita sede sagomata, mantiene il grado di tenuta stagna anche sulla filettatura. Dimensioni ridotte.

Made of nickel-plated brass. The tightening of the nut causes the deformation of the gasket which, besides ensuring a hermetic IP68 seal at 5 bar pressure, ensures an exceptional tearing resistance. A further o-ring gasket housed in a suitable shaped housing, maintains the degree of tightness even on the thread. Small size

- Standard **CEI EN 62444**
- Grado di protezione del sistema **IP68**

- Standard **IEC EN 62444**
- System protection degree **IP68**

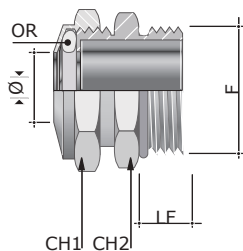

Filettatura Metrica Metric thread

CODICE CODE	SERRAGGIO CAVO CABLE TIGHTENING		DIMENSIONI mm DIMENSIONS mm		LF	CONFEZIONE PACKAGE pz / pcs.
	Ø Min - Ø Max	F	CH1	CH2		
	5 ÷ 9	M12x1,5	20	20	10	25
6018-M16A	5 ÷ 9	M16x1,5	20	20	10	25
6018-M1620	8 ÷ 12	M16x1,5	24	24	10	20
6018-M20	8 ÷ 12	M20x1,5	24	24	10	20
6018-M2025	11 ÷ 16	M20x1,5	30	30	10	15
6018-M25	11 ÷ 16	M25x1,5	30	30	10	15
6018-M2532	15 ÷ 21	M25x1,5	36	36	10	10
6018-M32	15 ÷ 21	M32x1,5	36	36	10	10
6018-M3240	20 ÷ 27	M32x1,5	45	45	10	10
6018-M40	20 ÷ 27	M40x1,5	45	45	12	10
6018-M50*	22 ÷ 35	M50x1,5	55	55	9	5
6018-M63*	35 ÷ 48	M63x1,5	65	65	10	5

* Temp. min -40°C / Temp. max 100°C
* Min. Temp. -40°C / Max Temp. 100°C



■ Pressacavo Cable gland

Adattatore pressacavo in ottone nichelato **6118** Cable gland adapter in nickel plated brass **6118**



Sono prodotti in ottone nichelato.
Sono raccordi pressacavo con testa filettata metrica maschio, adatti ad essere collegati a raccordi terminali per tubi metallici rigidi e pieghevoli.
Sono utilizzati quando è necessario rendere stagna una parte dell'impianto.

Produced in nickel-plated brass.
Cable gland fittings with male metric threaded head, suitable to be connected to terminal fittings for rigid and flexible folding metal conduits and of equal female thread.
They are used when it is necessary to make a part of the system waterproof.

- Standard **CEI EN 62444**
- Grado di protezione del sistema **IP68**

- Standards **IEC EN 62444**
- System protection degree **IP68**

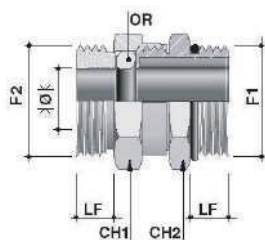

Filettatura Metrica Metric thread

CODICE CODE	SERRAGGIO CAVO CABLE TIGHTENING Ø Min - Ø Max	DIMENSIONI mm DIMENSIONS mm				CONFEZIONE PACKAGE pz / pcs.
		F1	F2	CH1	CH2	
6118-1216M	5 ÷ 9	M12x1,5	M16x1,5	20	20	20
6118-16M	5 ÷ 9	M16x1,5	M16x1,5	20	20	20
6118-1620M	8 ÷ 12	M16x1,5	M20x1,5	24	24	20
6118-20M	8 ÷ 12	M20x1,5	M20x1,5	24	24	20
6118-2025M	11 ÷ 16	M20x1,5	M25x1,5	30	30	20
6118-25M	11 ÷ 16	M25x1,5	M25x1,5	30	30	20
6118-2532M	15 ÷ 21	M25x1,5	M32x1,5	36	36	20
6118-32M	15 ÷ 21	M32x1,5	M32x1,5	36	36	20
6118-3240M	20 ÷ 27	M32x1,5	M40x1,5	45	45	10
6118-40M	20 ÷ 27	M40x1,5	M40x1,5	45	45	10



■ Pressacavo Cable gland

In acciaio inox AISI 303 **6018X** In stainless steel AISI 303 **6018X**



Sono prodotti in acciaio inox AISI 303 (X8Cr-Ni1809 1.4305 UNI EN10088-1).
La guarnizione in FPM garantisce un'ottima resistenza alla trazione del cavo ed un grado di protezione IP68/69.
Filettatura Metrica ISO secondo CEI EN 60423

Made of stainless steel AISI 303 (X8Cr-Ni1809 1.4305 UNI EN10088-1).
The FPM seal ensures excellent resistance to the traction of the cable and a degree of protection IP68/69.
ISO Metric thread according to IEC EN 60423

- Standard **CEI EN 62444**
- Grado IP del sistema **IP68 / IP69**

- Standard **IEC EN 62444**
- System protection degree **IP68 / IP69**

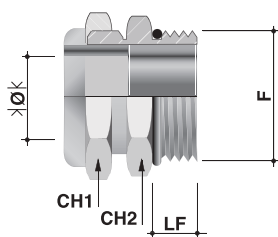

Filettatura Metrica Metric thread

CODICE CODE	SERRAGGIO CAVO CABLE TIGHTENING Ø Min - Ø Max	F	DIMENSIONI mm DIMENSIONS mm		LF	CONFEZIONE PACKAGE pz / pcs.
			CH1	CH2		
6018X-M08*	2,5 ÷ 3,5	M8x1,25	11	11	10	50
6018X-M081*	3,5 ÷ 5	M8x1,25	11	11	10	50
6018X-M10*	3 ÷ 4	M10x1,5	13	13	10	50
6018X-M101*	4 ÷ 6	M10x1,5	13	13	10	50
6018X-M12*	3,5 ÷ 5	M12x1,5	17	17	10	50
6018X-M121*	5 ÷ 6,5	M12x1,5	17	17	10	50
6018X-M123*	6,5 ÷ 8	M12x1,5	17	17	10	50
6018X-M16*	8 ÷ 10,5	M16x1,5	18	18	10	50
6018X-M20*	11 ÷ 15	M20x1,5	24	24	10	50
6018X-M25*	16 ÷ 20,5	M25x1,5	30	30	11	50
6018X-M32*	21 ÷ 25,5	M32x1,5	36	36	13	50
6018X-M40*	28,5 ÷ 33	M40x1,5	46	46	13	25
6018X-M50*	37 ÷ 42	M50x1,5	55	55	14	10
6018X-M63*	46 ÷ 52	M63x1,5	70	70	14	5

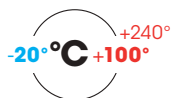

**IP68
IP69**

*A richiesta / On request

■ Pressacavo Cable gland

In acciaio inox AISI 316L **6018XX** In stainless steel AISI 316L **6018XX**

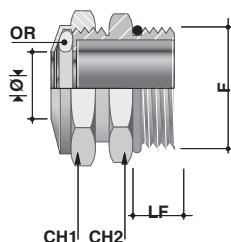

Prodotti in acciaio inox AISI 316L (X2CrNiMo17-12-2 1.4404 UNI EN 10088-1). Il serraggio del dado provoca la deformazione della guarnizione che, oltre a garantire una tenuta stagna IP68 a 5 bar di pressione, assicura una eccezionale tenuta allo strappo. Un'ulteriore guarnizione o-ring alloggiata in apposita sede sagomata, mantiene il grado di tenuta stagna anche sulla filettatura. Presentano un'ottima resistenza alla corrosione. La filettatura è metrica ISO in conformità alle norme CEI EN 60423. Dimensioni ridotte

- Standard **CEI EN 62444**
- Grado di protezione del sistema **IP 68**

Made of stainless steel AISI 316L (X2CrNiMo17-12-2 1.4404 UNI EN 10088-1). The tightening of the nut causes the deformation of the gasket which, besides ensuring a hermetic IP68 seal at 5 bar pressure, ensures an exceptional tearing resistance. A further o-ring gasket housed in a suitable shaped housing, maintains the degree of tightness even on the thread. They have an excellent resistance to corrosion. The ISO metric thread is in compliance with standards IEC EN 60423. Small size

- Standard **IEC EN 50262**
- System protection degree **IP68**

Filettatura Metrica Metric thread

CODICE CODE	SERRAGGIO CAVO CABLE TIGHTENING		DIMENSIONI mm DIMENSIONS mm			CONFEZIONE PACKAGE pz / pcs.
	Ø Min - Ø Max	F	CH1	CH2	LF	
6018XX-M1216	5 ÷ 9	M12x1,5	20	20	10	25
6018XX-M16	5 ÷ 9	M16x1,5	20	20	10	25
6018XX-M1620	8 ÷ 12	M16x1,5	24	24	10	20
6018XX-M20	8 ÷ 12	M20x1,5	24	24	10	20
6018XX-M2025	11 ÷ 16	M20x1,5	30	30	10	15
6018XX-M25	11 ÷ 16	M25x1,5	30	30	10	15
6018XX-M2532	15 ÷ 21	M25x1,5	36	36	10	10
6018XX-M32	15 ÷ 21	M32x1,5	36	36	10	10
6018XX-M3240	20 ÷ 27	M32x1,5	46	46	10	10
6018XX-M40	20 ÷ 27	M40x1,5	46	46	12	10

Accessori Accessories

Riduzioni 6016 Reductions 6016



**Tipo A
Type A**

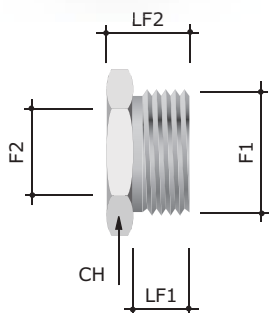

In conformità a tutti i raccordi filettati per tubi rigidi o pieghevoli. Sono utilizzate quando è necessario realizzare accoppiamenti tra imbrocci filettati diversi, sia per diametro che per tipo di filettatura.

Sono prodotte in ottone, nichelate successivamente per conferire una migliore resistenza alle avverse condizioni ambientali in cui saranno utilizzate. Continuità elettrica garantita

Gli articoli con un Ø nella colonna CH sono privi di esagono.

Filettature

- Metrico ISO CEI EN 60423
- GAS cilindrico UNI ISO 228
- PG secondo DIN 40430.

In accordance with all threaded fittings for rigid or flexible conduits.

They are used when it is necessary to realize couplings between different threaded inlets, both for diameter and for type of thread.

Made in brass, subsequently nickel plated to confer a better resistance to adverse environmental conditions where they will be used.

Electrical continuity guaranteed

Parts with a Ø in the column CH are without hexagon.

Threads

- ISO Metric IEC EN 60423
- UNI ISO 228 GAS cylindrical
- PG in accordance with DIN 40430

Metrico - Metrico Metric - Metric

CODICE CODE	DIMENSIONI mm DIMENSIONS mm					TIPO TYPE	CONFEZIONE PACKAGE pz / pcs.
	F1 m	F2 f	CH	LF2	LF1		
6016-1620	M16x1,5	M20x1,5	22	11	8	B	20
6016-2016	M20x1,5	M16x1,5	24	12	8	A	20
6016-2025	M20x1,5	M25x1,5	28	11	8	B	10
6016-2520	M25x1,5	M20x1,5	26	14	10	A	20
6016-2532	M25x1,5	M32x1,5	35	13	10	B	10
6016-3220	M32x1,5	M20x1,5	35	14	10	A	10
6016-3225	M32x1,5	M25x1,5	35	14	10	A	10
6016-3240	M32x1,5	M40x1,5	42	13	10	B	10
6016-4020	M40x1,5	M20x1,5	42	18	13	A	10
6016-4025	M40x1,5	M25x1,5	42	18	13	A	10
6016-4032	M40x1,5	M32x1,5	42	18	13	A	10
6016-4050	M40x1,5	M50x1,5	55	14	12	B	5
6016-5032	M50x1,5	M32x1,5	50	19	13	A	10
6016-5040	M50x1,5	M40x1,5	50	19	13	A	5
6016-5063	M50x1,5	M63x1,5	65	18	13	B	1
6016-6340	M63x1,5	M40x1,5	65	21	14	A	2
6016-6350	M63x1,5	M50x1,5	65	21	14	A	2



**Tipo B
Type B**

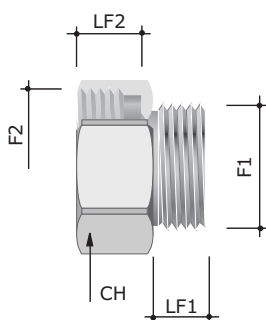

■ Accessori Accessories

Riduzioni 6019 - 6105 Reductions 6019 - 6105

Metrico - GAS ISO 228 Metric - GAS ISO 228

CODICE CODE	DIMENSIONI mm DIMENSIONS mm					TIPO TYPE	CONFEZIONE PACKAGE pz / pcs.
	F1 m	F2 f	CH	LF2	LF1		
6019-1638	M16x1,5	3/8"	18	11,0	8	B	10
6019-2012	M20x1,5	1/2"	24	11,0	8	B	20
6019-2534	M25x1,5	3/4"	30	12,5	10	B	10
6019-2538	M25x1,5	3/8"	26	14,0	10	A	10
6019-3201	M32x1,5	1"	35	13,0	10	B	10
6019-6302	M63x1,5	2"	65	19,0	15	B	2

Metrico - PG Metric - PG

CODICE CODE	DIMENSIONI mm DIMENSIONS mm					TIPO TYPE	CONFEZIONE PACKAGE pz / pcs.
	F1 m	F2 f	CH	LF2	LF1		
6105-1609	M16x1,5	9	ø 20	9	9	B	10
6105-1611	M16x1,5	11	ø 22	9	9	B	10
6105-2011	M20x1,5	11	ø 23	9	9	B	10
6105-2013	M20x1,5	13,5	24	9	9	B	10
6105-2516	M25x1,5	16	ø 27	9	9	B	10
6105-3221	M32x1,5	21	35	14	14	A	10
6105-4029	M40x1,5	29	42	18	18	A	5
6105-5036	M50x1,5	36	50	15	15	B	5
6105-6348	M63x1,5	48	65	15	15	B	2

GAS ISO 228 - Metrico GAS ISO 228 - Metric

CODICE CODE	DIMENSIONI mm DIMENSIONS mm					TIPO TYPE	CONFEZIONE PACKAGE pz / pcs.
	F1 m	F2 f	CH	LF2	LF1		
6019-1216	1/2"	M16x1,5	24	13,0	9,5	A	50
6019-3420	3/4"	M20x1,5	28	13,5	9,5	A	20
6019-0125	1"	M20x1,5	35	15,5	10,5	A	10
6019-0120	1"	M25x1,5	35	15,5	10,5	A	10
6019-0132	1"	M32x1,5	35	11,0	14,0	B	10
6019-11432	1" 1/4	M32x1,5	42	19,0	14,0	A	10
6019-11240	1" 1/2	M40x1,5	50	19,0	14,0	A	10
6019-0250	2"	M50x1,5	60	26,5	20,0	A	10
6019-0263	2"	M63x1,5	65	20,0	18,0	B	10
6019-21263*	2" 1/2	M63x1,5	ø 75	31,0	19,0	A	1

*In alluminio
*In aluminium

Accessori Accessories

Riduzioni 6054 Reductions 6054



**Tipo A
Type A**

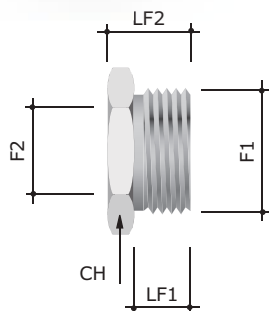

**Tipo B
Type B**

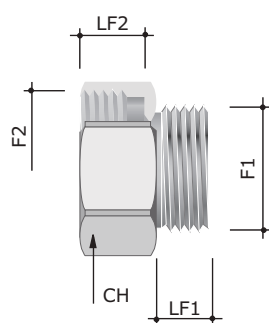

GAS ISO 228 - PG GAS ISO 228 - PG

CODICE CODE	DIMENSIONI mm DIMENSIONS mm					TIPO TYPE	CONFEZIONE PACKAGE pz / pcs.
	F1 m	F2 f	CH	LF2	LF1		
6054-0409	1/4"	9	18	10,0	8,0	B	10
6054-0411	1/4"	11	22	11,0	8,0	B	20
6054-0413	1/4"	13,5	24	11,0	8,0	B	20
6054-3809	3/8"	9	22	10,0	9,5	B	20
6054-3811	3/8"	11	22	9,5	9,0	B	20
6054-3813	3/8"	13,5	24	11,0	9,5	B	20
6054-3816	3/8"	16	24	9,5	9,0	B	20
6054-1209	1/2"	9	24	13,5	9,5	A	10
6054-1211	1/2"	11	24	9,5	9,0	B	20
6054-1213	1/2"	13,5	24	11,0	9,5	B	20
6054-1216	1/2"	16	24	11,0	9,5	B	20
6054-1221	1/2"	21	30	12,0	9,5	B	20
6054-3411	3/4"	11	28	13,5	9,5	A	10
6054-3413	3/4"	13,5	28	13,5	9,5	A	10
6054-3416	3/4"	16	28	13,5	9,5	A	10
6054-3421	3/4"	21	30	12,0	9,5	B	10
6054-3429	3/4"	29	40	13,0	11,0	B	10
6054-0111	1"	11	35	15,5	10,5	A	10
6054-0113	1"	13,5	35	15,5	10,5	A	10
6054-0116	1"	16	35	15,5	10,5	A	10
6054-0121	1"	21	35	15,5	10,5	A	10
6054-0129	1"	29	42	14,0	12,0	B	10
6054-11421	1" 1/4	21	45	19,0	13,0	A	5
6054-11436	1" 1/4	36	ø 50	16,0	14,0	B	10
6054-11236	1" 1/2	36	ø 55	16,0	14,0	B	5

Accessori

Accessories

Riduzioni 6004

Reductions 6004

GAS ISO 228 - GAS ISO 228

GAS ISO 228 - GAS ISO 228

CODICE CODE	DIMENSIONI mm DIMENSIONS mm					TIPO TYPE	CONFEZIONE PACKAGE pz / pcs.
	F1 m	F2 f	CH	LF2	LF1		
6004-0438	1/4"	3/8"	18	11,0	8,0	B	10
6004-0412	1/4"	1/2"	24	11,0	8,0	B	10
6004-0434	1/4"	3/4"	30	12,0	7,0	B	10
6004-3804	3/8"	1/4"	22	13,0	9,5	A	20
6004-3812	3/8"	1/2"	24	11,0	9,5	B	20
6004-3834	3/8"	3/4"	28	12,5	9,5	B	10
6004-1204	1/2"	1/4"	24	13,0	9,5	A	20
6004-16	1/2"	3/8"	24	13,0	9,5	A	50
6004-1234	1/2"	3/4"	28	12,5	9,5	B	10
6004-1201	1/2"	1"	38	10,0	13,0	B	5
6004-3438	3/4"	3/8"	28	13,5	9,5	A	20
6004-3412	3/4"	1/2"	28	13,5	9,5	A	20
6004-3401	3/4"	1"	35	13,0	9,5	B	10
6004-138	1"	3/8"	35	15,5	10,5	A	10
6004-112	1"	1/2"	35	15,5	10,5	A	10
6004-134	1"	3/4"	35	15,5	10,5	A	10
6004-1114	1"	1" 1/4	ø 50	18,0	14,0	B	5
6004-1112	1"	1" 1/2	50	19,0	14,0	B	5
6004-11438*	1" 1/4	3/8"	42	24,0	15,0	A	10
6004-11412	1" 1/4	1/2"	42	22,0	15,0	A	10
6004-11434*	1" 1/4	3/4"	42	23,0	15,0	A	10
6004-1141*	1" 1/4	1"	42	23,0	15,0	A	5
6004-1412	1" 1/4	1" 1/2	50	15,0	16,0	B	5
6004-11238*	1" 1/2	3/8"	50	25,0	17,0	A	10
6004-11212	1" 1/2	1/2"	50	25,0	17,5	A	5
6004-11234	1" 1/2	3/4"	50	25,0	17,5	A	5
6004-1121	1" 1/2	1"	50	21,0	15,0	A	5
6004-1214*	1" 1/2	1" 1/4	50	25,0	17,0	A	5
6004-11202	1" 1/2	2"	ø 65	19,0	16,5	B	10
6004-0234*	2"	3/4"	60	27,0	20,0	A	5
6004-21*	2"	1"	60	27,0	20,0	A	5
6004-2114	2"	1" 1/4	60	27,0	20,0	A	10
6004-2112*	2"	1" 1/2	60	27,0	20,0	A	5

* Prodotti in acciaio zincato
* Made of galvanized steel

■ Accessori Accessories

Riduzioni 6104 Reductions 6104



Tipo A
Type A

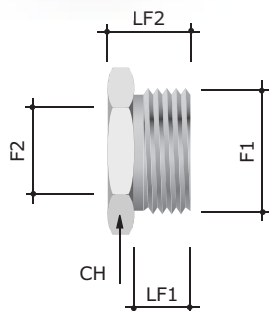

Tipo B
Type B

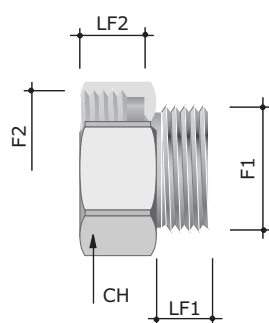

PG - PG PG - PG

CODICE CODE	DIMENSIONI mm DIMENSIONS mm					TIPO TYPE	CONFEZIONE PACKAGE pz / pcs.
	F1 m	F2 f	CH	LF2	LF1		
6104-0709	07	09	ø18	10,0	5,0	B	10
6104-0907	09	07	18	8,0	5,0	A	10
6104-0911	09	11	ø20	9,5	6,0	B	10
6104-0913	09	13,5	ø23	10,5	6,0	B	10
6104-1107	11	07	19	9,0	6,0	A	10
6104-1109	11	09	19	9,0	6,0	A	10
6104-1113	11	13,5	ø23	10,5	6,0	B	10
6104-1116	11	16	ø27	11,5	6,0	B	10
6104-1309	13,5	09	22	9,0	6,0	A	10
6104-1311	13,5	11	22	9,0	6,0	A	10
6104-1316	13,5	16	27	11,5	6,5	B	20
6104-1321	13,5	21	ø31	13,0	6,5	B	10
6104-1607	16	07	23	10,0	7,0	A	10
6104-1609	16	09	24	10,5	6,5	A	10
6104-1611	16	11	24	9,0	6,0	A	10
6104-1613	16	13,5	24	9,0	6,0	A	10
6104-1621	16	21	30	13,0	6,5	B	10
6104-2113	21	13,5	30	10,0	7,0	A	10
6104-2116	21	16	30	10,0	7,0	A	10
6104-2129	21	29	42	13,0	7,0	B	10
6104-2921	29	21	42	11,0	7,5	A	20
6104-2936	29	36	50	12,0	10,5	B	5
6104-3629	36	29	50	12,0	8,5	A	5
6104-4236	42	36	58	15,0	11,0	A	5
6104-4248	42	48	63	23,0	10,0	B	5
6104-4842	48	42	60	14,0	10,0	A	5

■ Accessori Accessories

Riduzioni 6054 Reductions 6054

PG - GAS ISO 228 PG - GAS ISO 228

CODICE CODE	DIMENSIONI mm DIMENSIONS mm					TIPO TYPE	CONFEZIONE PACKAGE pz / pcs.
	F1 m	F2 f	CH	LF2	LF1		
6054-0704	07	1/4"	18	11,0	9,0	B	20
6054-0738	07	3/8"	18	11,0	9,0	B	20
6054-0904	09	1/4"	18	11,0	9,0	B	20
6054-0938	09	3/8"	19	9,0	9,0	B	20
6054-0912	09	1/2"	24	12,0	7,0	B	10
6054-1104	11	1/4"	22	11,5	7,0	A	20
6054-1138	11	3/8"	22	11,0	9,0	B	20
6054-1112	11	1/2"	24	11,0	9,0	B	20
6054-1304	13,5	1/4"	22	11,5	7,5	A	20
6054-1338	13,5	3/8"	24	11,5	7,5	A	20
6054-1312	13,5	1/2"	24	11,0	9,0	B	20
6054-1334	13,5	3/4"	30	12,5	9,0	B	10
6054-1604	16	1/4"	24	11,5	7,5	A	20
6054-1638	16	3/8"	24	11,5	7,5	A	20
6054-1612	16	1/2"	24	11,0	7,0	B	20
6054-1634	16	3/4"	30	12,5	7,0	B	10
6054-2138	21	3/8"	30	11,5	7,5	A	20
6054-2112	21	1/2"	30	11,5	7,5	A	20
6054-2134	21	3/4"	30	12,5	7,0	B	10
6054-2101	21	1"	35	12,5	7,0	B	10
6054-2934	29	3/4"	42	13,0	8,0	A	10
6054-2901	29	1"	39	15,0	10,0	A	10
6054-29114	29	1" 1/4	42	15,0	10,5	B	5
6054-36114	36	1" 1/4	50	17,5	11,5	A	5
6054-36112	36	1" 1/2	50	16,0	14,0	B	5
6054-42114	42	1" 1/4	58	18,0	12,0	A	5
6054-42112	42	1" 1/2	58	18,0	12,0	A	5

■ Accessori Accessories

Tappi 6050 Plugs 6050



Accessorio in ottone nichelato filettato esternamente, utilizzato per la chiusura di fori filettati non utilizzati.

Filettature

- Metrica ISO CEI EN 60423
- GAS cilindrico UNI ISO 228

Accessory in nickel plated brass externally threaded, used for closing the threaded holes not used.

Threads

- ISO metric IEC EN 60423
- UNI ISO 228 GAS cylindrical

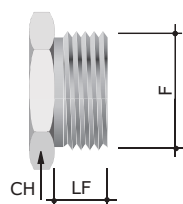

Metrico Metric

CODICE CODE	DIMENSIONI DIMENSIONS mm			CONFEZIONE PACKAGING
	F	CH	LF	
6050-16A	M 16x1,5	22	8	20
6050-20	M 20x1,5	24	8	20
6050-25	M 25x1,5	28	10	20
6050-32A	M 32x1,5	35	10	20
6050-40	M 40x1,5	45	12	20
6050-50	M 50x1,5	55	13	10
6050-63	M 63x1,5	70	14	5

GAS ISO 228 GAS ISO 228

CODICE CODE	DIMENSIONI DIMENSIONS mm			CONFEZIONE PACKAGING
	F	CH	LF	
6050-16	3/8"	22	8,5	20
6050-12	1/2"	24	8,5	20
6050-34	3/4"	28	8,5	20
6050-1	1"	35	10,0	10
6050-114	1" 1/4	45	14,5	10
6050-112	1" 1/2	50	16,0	10
6050-60	2"	65	17,5	5

Nippli 6051 Nipples 6051



Accessorio in ottone nichelato filettato esternamente, che permette la giunzione tra particolari aventi fori filettati uguali.

Filettature

- Metrica ISO CEI EN 60423
- GAS cilindrico UNI ISO 228

Accessory in nickel plated brass externally threaded, which allows the junction between parts having same threaded holes.

Threads

- ISO metric IEC EN 60423
- UNI ISO 228 GAS cylindrical

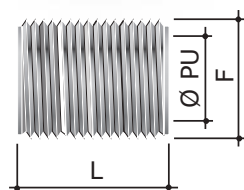

Metrico Metric

CODICE CODE	DIMENSIONI DIMENSIONS mm			CONFEZIONE PACKAGING
	F	ø PU	LF	
6051-16A	M 16x1,5	12	21,0	20
6051-20	M 20x1,5	15	24,5	20
6051-25	M 25x1,5	20	25,0	20
6051-32A	M 32x1,5	26	32,0	20
6051-40	M 40x1,5	36	30,0	25
6051-50	M 50x1,5	41	50,0	5
6051-63	M 63x1,5	58	50,5	5

GAS ISO 228 GAS ISO 228

CODICE CODE	DIMENSIONI DIMENSIONS mm			CONFEZIONE PACKAGING
	F	ø PU	L	
6051-16	3/8"	12	21,0	50
6051-12	1/2"	15	24,5	20
6051-34	3/4"	21	28,0	10
6051-1	1"	26	32,0	10
6051-114	1" 1/4	32	40,0	10
6051-112	1" 1/2	38	40,0	10
6051-60	2"	50	44,0	5

Accessori Accessories

Manicotto 6003 Coupling 6003

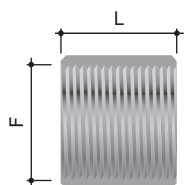

Filettatura metrica Metric thread

CEI EN 61386	
CEI EN 61386	

Prodotti in ottone, nichelati successivamente per conferire una migliore resistenza alle avverse condizioni ambientali in cui saranno utilizzati.

Questi raccordi permettono la giunzione tra due filetti maschi uguali, pertanto non possono essere utilizzati con i tubi metallici rigidi non filettabili. L'accoppiamento raccordo-tubo rigido avviene per avvitamento sul tubo.

Continuità elettrica garantita

Il grado di protezione se correttamente avvitati è IP66, la continuità elettrica è nel rispetto delle norme CEI.

Filettature

- Metrica ISO CEI EN 60423
- GAS cilindrico UNI ISO 228

Made of brass which is then nickel plated in order to improve resistance to the harsh environmental conditions in which they are used.

These fittings allow the junction between two equal male threads and therefore cannot be used with non-threadable metal rigid conduits.

The coupling fitting-rigid tube occurs by screwing onto the conduit.

Electrical continuity guaranteed

The degree of protection if properly screwed is IP67, electrical continuity is in compliance with the IEC standards.

Threads

- ISO metric CEI EN 60423
- UNI ISO 228 GAS cylindrical

Filettatura Metrica Metric thread

CODICE CODE	Tubo Ø	DIMENSIONI DIMENSIONS mm		CONFEZIONE PACKAGING
		F	L	
6003-16A	16	M16 x 1,5	27,0	100
6003-20	20	M20 x 1,5	30,0	100
6003-25	25	M25 x 1,5	36,0	50
6003-32A	32	M32 x 1,5	40,0	25
6003-40	40	M40 x 1,5	40,0	20
6003-50	50	M50 x 1,5	50,0	5
6003-63*	63	M63 x 1,5	65,0	2

* Prodotto senza certificazioni
* Product without certifications

Filettatura GAS ISO 228 GAS ISO 228 thread

CODICE CODE	Tubo Ø	DIMENSIONI DIMENSIONS mm		CONFEZIONE PACKAGING
		F	L	
6003-16	3/8"	3/8"	20	100
6003-12	1/2"	1/2"	22	100
6003-34	3/4"	3/4"	28	50
6003-1	1"	1"	28	25
6003-114	1" 1/4	1" 1/4	48	10
6003-112	1" 1/2	1" 1/2	48	5
6003-60	2"	2"	56	1
6003-212*	2" 1/2	2" 1/2	65	1
6003-03*	3"	3"	71	1
6003-04*	4"	4"	83	1

* Prodotti in acciaio zincato
*Made of galvanized steel

■ Accessori Accessories

Raccordi curvi 45° 6028 Elbow 45° 6028

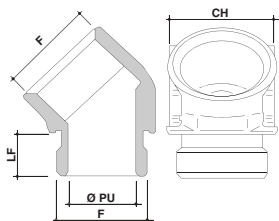

Sono prodotti da stampaggio, realizzati in ottone e nichelati successivamente per conferire una migliore resistenza alle avverse condizioni ambientali in cui saranno utilizzati.

Le estremità presentano una filettatura maschio ed una femmina.

La tenuta dell'accoppiamento è garantita dalla guarnizione o-ring alloggiata sull'im-bocco maschio.

L'accurata realizzazione di questi raccordi, assicura un perfetto infilaggio dei cavi senza rischio di danneggiamento del rivestimento.

Filettatura Metrica ISO in conformità con le norme CEI EN 60423.

Continuità elettrica garantita

Produced by moulding, made of brass and subsequently nickel plated to confer a better resistance to the adverse environmental conditions in which they will be used.

The ends have a male and a female thread.

The tightness of the coupling is ensured by the o-ring gasket housed on the male inlet.

The accurate realization of these fittings, ensures a perfect threading of cables without the risk of damaging the coating. ISO Metric thread in accordance with the standards IEC EN 60423.

Electrical continuity guaranteed

■ Standard CEI EN 61386

■ Standard IEC EN 61386

CODICE CODE	F1	DIMENSIONI mm DIMENSIONS mm			CONFEZIONE PACKAGE pz / pcs.
		ØP	CH	LF	
6028-16	M16x1,5	11,5	19	10	25
6028-20	M20x1,5	15	23	10	20
6028-25	M25x1,5	20	28	10	10
6028-32	M32x1,5	27	36	10	20

Raccordi curvi 90° 6029 Elbow 90° 6029

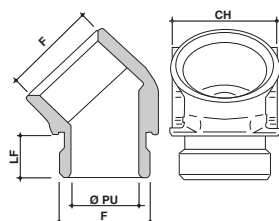

Sono prodotti da stampaggio, realizzati in ottone e nichelati successivamente per conferire una migliore resistenza alle avverse condizioni ambientali in cui verranno utilizzati.

Le estremità presentano una filettatura maschio ed una femmina. La particolare esecuzione degli imbocchi, consente di accoppiare due elementi ed ottenere una curva a 90° perfettamente allineata e di dimensioni ridotte.

La tenuta dell'accoppiamento è garantita dalla guarnizione o-ring alloggiata sull'im-bocco maschio.

Continuità elettrica garantita

L'accurata realizzazione di questi raccordi, assicura un perfetto infilaggio dei cavi senza rischio di danneggiamento del rivestimento.

Filettatura Metrica ISO in conformità con le norme CEI EN 60423.

Produced by moulding, made of brass and subsequently nickel plated to confer a better resistance to the adverse environmental conditions in which they will be used.

The ends have a male and a female thread.

The special way in which the mouthpieces have been designed, allows to couple two elements and obtain a 90° bend perfectly aligned and small in size.

The tightness of the coupling is ensured by the o-ring gasket housed on the male inlet.

Electrical continuity guaranteed

The accurate realization of these fittings, ensures a perfect threading of cables without the risk of damaging the coating. ISO Metric thread in accordance with the standards IEC EN 60423.

■ Standard CEI EN 61386

■ Standard IEC EN 61386

CODICE CODE	F1	DIMENSIONI mm DIMENSIONS mm			CONFEZIONE PACKAGE pz / pcs.
		ØP	CH	LF	
6029-16	M16x1,5	11,5	19	10	10
6029-20	M20x1,5	15	23	10	10
6029-25	M25x1,5	20	28	10	10
6029-32	M32x1,5	27	36	10	10

Accessori Accessories

Adattatori girevoli di posizionamento a 45° per raccordi filetto maschio 6028-G Swivel adapters for positioning at 45° for male thread fittings 6028-G

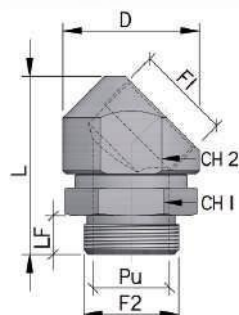

IP68 Statico
Static

IP67 Dinamico
Dynamic

Realizzati in ottone nichelato, questi adattatori di posizionamento consentono di orientare l'uscita dei cavi, per ridurne al minimo lo stress, in condizioni particolari di temperatura e sollecitazioni meccaniche. Una guarnizione interna garantisce la tenuta IP nella connessione girevole. Utilizzabili con tutti i raccordi filetto metrico per tubi metallici o in poliammide. La particolare cura nell'esecuzione assicura un perfetto infilaggio dei cavi senza rischio di danneggiamento del rivestimento. Filetto Metrico ISO in conformità alla norma CEI EN 60423.

- Standard
CEI EN 61386-1 e CEI EN 60423
- Grado IP CEI EN 60529
IP68 statico / IP67 dinamico

Made in nickel-plated brass, these positioning adapters make it possible to select the direction of the cable outlet and to reduce stress to a minimum in a particular temperature and mechanical strain conditions.

An internal seal guarantees the IP sealing in the swivel connection. Usable with all metric threaded connectors for metal and polyamide conduits. The particular care in the execution ensures perfect insertion of cables without risk of damaging the coating. ISO Metric thread in compliance with IEC EN 60423.

- Standards
IEC EN 61386-1 and IEC EN 60423
- System protection degree IEC EN 60529
IP68 static / IP67 dynamic

CODICE CODE	DIMENSIONI mm		DIMENSIONS mm							CONFEZIONE	
	F1 in	F2 out	ØD	CH1	CH2	LF	L	PU	Kg/pz pcs	PACKAGE pz / pcs.	
6028-20G	M20x1,5	M20x1,5	34	26	30	10	48	15	0,12	10	
6028-25G	M25x1,5	M25x1,5	38	32	34	10	52	20	0,17	10	
6028-32G	M32x1,5	M32x1,5	46	39	41	13	60	26	0,26	10	
6028-40G	M40x1,5	M40x1,5	55	50	50	14	70	32	0,45	10	
6028-50G	M50x1,5	M50x1,5	65	55	56	18	85	39,5	0,64	10	
6028-63G	M63x1,5	M63x1,5	80	65	70	18	97	49	1,11	10	

Ghiere

Ring nuts

In ottone nichelato **6006**

Nickel plated brass **6006**



Sono prodotte in ottone, nichelate successivamente per conferire resistenza alle avverse condizioni ambientali in cui verranno utilizzate.

Tipo A: sono costruite con un'ampia superficie di appoggio circolare.

Tipo B: sono ricavate da barra esagonale.

Made in brass, subsequently nickel plated to confer a better resistance to adverse environmental conditions where they will be used.

Type A: made with a wide round bearing surface.

Type B: made with hexagonal bar.

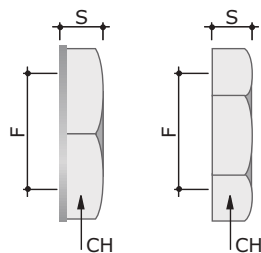

Tipo A
Type A

Tipo B
Type B

Filettatura metrica Tipo A Metric thread Type A

CODICE CODE	F	DIMENSIONI mm DIMENSIONS mm		CONFEZIONE PACKAGE pz / pcs.
		CH	S	
6006-16A	M16 x 1,5	18	5,5	100
6006-20	M20 x 1,5	22	5,5	100
6006-25	M25 x 1,5	29	5,5	75
6006-32A	M32 x 1,5	38	7,5	100
6006-40	M40 x 1,5	45	6,5	50
6006-50	M50 x 1,5	54	7,5	50
6006-63	M63 x 1,5	66	9,5	20

Filettatura Gas Tipo A Gas thread Type A

CODICE CODE	F	DIMENSIONI mm DIMENSIONS mm		CONFEZIONE PACKAGE pz / pcs.
		CH	S	
6006-14	1/4"	15	4,0	50
6006-16	3/8"	18	5,5	100
6006-12	1/2"	24	5,5	75
6006-34	3/4"	29	5,5	75
6006-1	1"	38	7,5	100
6006-114	1" 1/4	45	6,5	50
6006-112	1" 1/2	54	8,0	50
6006-60	2"	66	9,5	20
6006-212*	2" 1/2	85	10,0	5
6006-03*	3"	100	14,0	1
6006-04*	4"	125	15,0	1

* Prodotti in alluminio Tipo B

*Aluminium products type B

Filettatura PG Tipo B PG thread Type B

CODICE CODE	F	DIMENSIONI mm DIMENSIONS mm		CONFEZIONE PACKAGE pz / pcs.
		CH	S	
6006-07	07	15	3,0	50
6006-09	09	18	3,0	50
6006-11	11	21	3,0	50
6006-13	13,5	23	3,0	50
6006-15	16	26	3,0	50
6006-21	21	32	3,5	50
6006-29	29	41	4,0	25
6006-36	36	51	5,0	20
6006-42	42	60	5,0	5
6006-48	48	64	5,5	10

■ Ghiere Ring nuts

Ribassate 6006E - 6006XX

Recessed 6006E - 6006XX

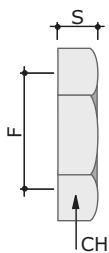

Ricavate da barra esagonale e presentano spessore ridotto, indicate per i pressacavi art. 6018M ed raccordi con filetti di dimensione contenuta. Permettono la giunzione tra raccordi filettati ed apparecchiature prive di fori filettati. Prodotti in conformità alle norme CEI EN 50262
Continuità elettrica garantita
La filettatura è Metrica ISO in conformità con le norme CEI EN 60423.

Made from hexagonal bar with reduced thickness, indicated for the glands art. 6018M and for fittings with extremely small threads. They facilitate the coupling between threaded fittings and equipment without threaded holes. Products in compliance with standards IEC EN 50262. Electrical continuity guaranteed
The thread is ISO Metric in conformity with the standards IEC EN 60423.

Ottone nichelato - Filettatura metrica Nickel plated brass - Metric thread

CODICE CODE	DIMENSIONI mm DIMENSIONS mm			CONFEZIONE PACKAGE pz / pcs.
	F1	CH	S	
6006E-12	M12 x 1,5	15	3,0	50
6006E-16	M16 x 1,5	19	3,0	50
6006E-20	M20 x 1,5	24	3,5	50
6006E-25	M25 x 1,5	30	3,5	50
6006E-32	M32 x 1,5	36	4,5	50
6006E-40	M40 x 1,5	46	4,5	10
6006E-50	M50 x 1,5	55	5,5	10
6006E-63	M63 x 1,5	70	6,0	10
6006E-75	M75 x 1,5	85	8,0	1
6006E-90	M90 x 2	102	10,0	1

Acciaio INOX 316L - Filettatura metrica Stainless steel - Metric thread

CODICE CODE	DIMENSIONI mm DIMENSIONS mm			CONFEZIONE PACKAGE pz / pcs.
	F1	CH	S	
6006-16XX	M16 x 1,5	20	3,0	10
6006-20XX	M20 x 1,5	24	3,5	10
6006-25XX	M25 x 1,5	30	3,5	10
6006-32XX	M32 x 1,5	36	3,5	10
6006-40XX	M40 x 1,5	45	4,5	5
6006-50XX	M50 x 1,5	55	5,5	5
6006-63XX	M63 x 1,5	70	6,0	5
6006-75XX*	M75 x 1,5	85	8,0	1
6006-90XX*	M90 x 2	102	10,0	1

*A richiesta / On request

Dentellate 6006EMC Serrated 6006EMC



Realizzate in ottone nichelato con dentellatura anti-rotazione.
Continuità elettrica garantita

Made of nickel-plated brass with anti-rotation notching.
Guaranteed electrical continuity

CODICE CODE	DIMENSIONI mm DIMENSIONS mm			CONFEZIONE PACKAGE pz / pcs.
	F1	CH	S	
6006EMC-16A	M16 x 1,5	20	3,0	50
6006EMC-20	M20 x 1,5	24	3,5	50
6006EMC-25	M25 x 1,5	30	3,5	20
6006EMC-32A	M32 x 1,5	35	4,5	20
6006EMC-40	M40 x 1,5	45	4,5	20
6006EMC-50	M50 x 1,5	55	5,5	10
6006EMC-63*	M63 x 1,5	70	6,0	5
6006EMC-75*	M75 x 1,5	80	8,0	1

*A richiesta / On request

■ Guarnizione Gasket

In rame **6060R**

In copper **6060R**

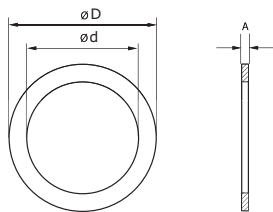

Realizzate in rame ricotto, presentano ottima resistenza meccanica e termica. Impiegate in accoppiamenti tra componenti metallici, particolarmente indicate per impieghi gravosi.

Made of annealed copper, with excellent mechanical and thermal resistance. Used in couplings between metal components, are particularly suitable for heavy duty applications.

CODICE CODE	GAS	FILETTO THREAD		Ø d	DIMENSIONI mm DIMENSIONS mm		CONFEZIONE PACKAGE pz / pcs.
		PG	Metrico Metric		Ø D	S	
6060R1318*	1/4"	7	-	13,2	19,5	1,5	100
6060R1622*	-	9	M16	16,1	22,0	1,5	100
6060R1724*	3/8"	-	-	17,0	22,5	1,5	100
6060R1924*	-	11	-	18,7	26,0	1,5	100
6060R2026*	-	13,5	M20	20,1	26,0	1,5	100
6060R2127*	1/2"	-	-	21,0	27,0	1,5	100
6060R2330*	-	16	-	22,7	30,0	1,5	50
6060R2532*	-	-	M25	25,1	32,0	1,5	50
6060R2632*	3/4"	-	-	26,6	32,5	1,5	50
6060R2834*	-	21	-	28,4	34,0	1,5	50
6060R3238*	-	-	M32	32,2	38,0	1,5	50
6060R3341*	1"	-	-	33,4	41,0	1,5	50
6060R3743*	-	29	-	36,7	43,0	1,5	50
6060R4050*	-	-	M40	40,2	50,0	1,5	20
6060R4250*	1" 1/4	-	-	42,2	50,0	1,5	25
6060R4756*	-	36	-	47,0	56,0	1,5	25
6060R4855*	1" 1/2	-	-	48,3	55,0	1,5	25
6060R5060*	-	-	M50	50,2	60,0	1,5	20
6060R6070*	2"	48	-	60,3	70,0	1,5	10
6060R6373*	-	-	M63	63,3	73,0	1,5	10

*A richiesta / On request

In perbunan **6060F**

In perbunan **6060F**

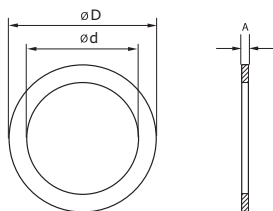

Realizzate in Perbunan (NBR), presentano elevata resistenza all'abrasione e buona resistenza meccanica. Eccellente a contatto con olii minerali, grasso, benzina, gas e acidi blandi.

Made in Perbunan (NBR), with high abrasion resistance and good mechanical resistance. Excellent behaviour in contact with mineral oils, grease, petrol, gas and mild acids.

CODICE CODE	GAS	FILETTO THREAD		Ø d	DIMENSIONI mm DIMENSIONS mm		CONFEZIONE PACKAGE pz / pcs.
		PG	Metrico Metric		Ø D	A	
6060F1220	-	7	M12	12,0	20,0	1,5	50
6060F1417	1/4"	-	-	14,0	17,0	1,5	50
6060F1623	-	9	M16	16,0	23,0	2	50
6060F1823	3/8"	11	-	18,5	22,5	2	50
6060F2029	-	13,5	M20	20,0	29,0	2	50
6060F2127	1/2"	16	-	21,0	27,0	2	50
6060F2537	-	-	M25	25,0	37,0	2	50
6060F2834	3/4"	21	-	27,0	34,0	2,5	25
6060F3244	-	-	M32	32,0	44,0	2	25
6060F3340	1"	-	-	34,0	43,0	2	25
6060F3742	-	29	-	35,0	43,0	2,5	25
6060F4052	-	-	M40	40,0	52,0	2	25
6060F4251	1" 1/4	-	-	42,5	51,0	3	25
6060F4855	1" 1/2	36	-	48,5	55,0	3	25
6060F5064	-	-	M50	50,0	64,0	2,5	25
6060F6166	2"	48	-	60,5	66,0	3	10
6060F6368	-	-	M63	63,0	68,0	3	10

■ Guarnizione Gasket

In fibra **6060**

In fibre **6060**

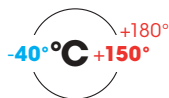
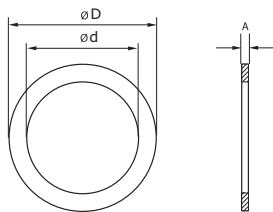

Realizzate in fibra di cellulosa con legante elastomerico (esente Amianto), presentano buona resistenza meccanica e termica. Per impieghi a contatto con carburanti, olii animali e vegetali, lubrificanti e gas.

Made of cellulose fibre with elastomeric binder (asbestos-free), with good mechanical and thermal resistance. Suitable for use in contact with fuels, animal and vegetable oils, lubricants and gas.

CODICE CODE	GAS	FILETTO THREAD		DIMENSIONI mm DIMENSIONS mm			CONFEZIONE PACKAGE pz / pcs.
		PG	Metrico Metric	Ø d	Ø D	A	
6060-1319	1/4"	7	-	13,0	19,5	1,8	100
6060-1522	-	9	M16	16,0	22,0	1,8	100
6060-1722	3/8"	-	-	16,5	22,5	1,8	100
6060-1925	-	11	M20	20,0	26,0	1,8	100
6060-2127	1/2"	13,5	-	21,0	27,0	1,8	100
6060-2228	-	16	-	22,5	29,0	1,8	100
6060-2532	-	-	M25	25,0	32,0	1,8	100
6060-2632	3/4"	-	-	26,3	32,5	1,8	100
6060-2834	-	21	-	28,3	34,5	1,8	100
6060-3238	-	-	M32	32,0	38,5	1,8	100
6060-3340	1"	-	-	33,2	40,0	1,8	100
6060-3742	-	29	-	37,6	43,5	1,8	100
6060-4050	-	-	M40	40,0	50,0	1,8	50
6060-4249	1" 1/4	-	-	42,0	49,0	1,8	50
6060-4956	1" 1/2	36	-	47,8	56,5	1,8	50
6060-5060	-	-	M50	50,0	59,5	1,8	25
6060-6070	2"	48	-	60,0	70,0	1,8	25
6060-6472	-	-	M63	63,0	72,0	1,8	25
6060-212*	2" 1/2	-	M75	75,2	86,0	1,8	10
6060-03*	3"	-	-	87,8	97,0	1,8	10
6060-04*	4"	-	-	113,0	124,0	1,8	10

*A richiesta / On request

In poliammide **6060PA**

In polyamide **6060PA**

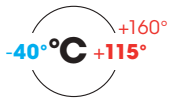
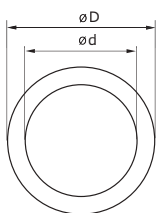

Realizzate in poliammide PA6 naturale, presentano elevata resistenza all'abrasione ed ottima resistenza meccanica. Autoestinguenti e prive di sostanze alogene, silicone e cadmio, presentano alta resistenza agli oli e benzine, in particolare ad acidi e solventi.

Made of natural PA6 polyamide, with high resistance to abrasion and excellent mechanical resistance. Self-extinguishing and free of halogen, silicone and cadmium, with high resistance to oils and fuel, in particular to acids and solvents.

CODICE CODE	FILETTO THREAD Metrico Metric	DIMENSIONI mm DIMENSIONS mm			CONFEZIONE PACKAGE pz / pcs.
		Ø d	Ø D	S	
6060PA1622	M16	16	22	1,5	100
6060PA2026	M20	20	26	1,5	100
6060PA2532	M25	25	32	1,5	100
6060PA3239	M32	32	39	1,5	100
6060PA4048	M40	40	48	1,5	50
6060PA5060	M50	50	60	1,5	25

■ Curvatubi Conduit bending machine

Caratteristiche Generali General Characteristics

Attrezzature portatili costruite in lega speciale di alluminio, risultano particolarmente adatte alla curvatura dei nostri tubi, in quanto, lavorando per avvolgimento, sono insensibili all'eventuale incrudimento dei materiali provocato dal processo produttivo dei tubi. L'incrudimento infatti, può avere influenze negative sulla qualità della curva se si utilizzano i sistemi di curvatura a spinta.

Velocità nel cambio degli utensili in soli 10 secondi, grazie al sistema di cambio rapido della contromatrice ed alla presa a trasmissione esagonale sulle matrici.

Il sistema brevettato senza anima, garantisce una curva di buona qualità con un raggio di curvatura pari a 2,5 o 3 volte il diametro del tubo a seconda delle dimensioni.

NOTA

Per un impiego sistematico su tubi in acciaio inox, si consiglia l'utilizzo di matrici in acciaio (non in dotazione standard)

Portable equipment built in a special aluminium alloy, particularly suited for bending our conduits, because, since they are winding operated, they are insensitive to possible work hardening of the material caused by the production process of the conduits.

The work hardening can have negative influences on the quality of the curve if you use thrust bending systems.

Speed in changing tools, in just 10 seconds,

thanks to the quick changing system of the female die and to the hex drive socket on the matrices.

The patented system without core ensures a good quality curve with a bending radius equal to 2.5 or 3 times the diameter of the conduit depending on the size.

NOTE

*** For a systematic use on stainless steel conduits, it is recommended to use steel matrices (not supplied as standard)**

Dotazioni / Ricambi Equipment / spare parts



CODICE CODE	PRODOTTO PRODUCT	CODICE MACCHINA MACHINE CODE				
		6255	6252-1640	6253-1640	6242-1650	6242P-1650
6252-C	Cavalletto Stand	●	●	●		
	Cassetta porta matrici Male dies box	●	●	●	●	●
6252C16	Contromatrici D.16 Female dies D.16	●	●	●	●	●
6252C20	Contromatrici D.20 Female dies D.20	●	●	●	●	●
6252C25	Contromatrici D.25 Female dies D.25	●	●	●	●	●
6252C32	Contromatrici D.32 Female dies D.32	●	●	●	●	●
6252C40	Contromatrici D.40 Female dies D.40		●	●	●	●
6252C50	Contromatrici D.50 Female dies D.50				●	●
6252M16	Matrice D.16 (spess. 1/1,2) Die D.16 (Thickness 1/1,2)	●	●	●	●	●
6252M20	Matrice D.20 (spess. 1/1,2) Die D.20 (Thickness 1/1,2)	●	●	●	●	●
6252M25	Matrice D.25 (spess. 1/1,5) Die D.25 (Thickness 1/1,5)	●	●	●	●	●
6252M32	Matrice D.32 (spess. 1,2/1,5) Die D.32 (Thickness 1,2/1,5)	●	●	●	●	●
6252M40	Matrice D.40 (spess. 1,2/1,5) Die D.40 (Thickness 1,2/1,5)		●	●	●	●
6252M50	Matrice D.50 (spess. 1,2/1,5) Die D.50 (Thickness 1,2/1,5)				●	●

■ Curvatubi Conduit bending machine

Minicurvatubi elettronica 6255

Mini electronic conduit bending machine 6255



Curvatubi con programmazione elettronica dell'angolo di curvatura. Fornita completa di cavalletto pieghevole, cassetta metallica contenente la macchina e gli accessori, matrici e contromatrici di diametro Ø16mm, Ø20mm, Ø25mm, Ø32mm.

- Peso **15 Kg**
- Capacità di curvatura:
Tubo acciaio zincato cod.6008:
da Ø16 mm a Ø32 mm
*Tubo acciaio INOX AISI 304 e 316
cod.6700 – 6700A: **da Ø16mm a Ø25mm**

Conduit bending machines with electronic programming of the bending angle. Supplied with folding easel, metal box containing machine and accessories, male and female dies diameter Ø16mm, Ø20mm, Ø25mm, Ø32mm.

- Weight **15 Kg**
- Bending capacity:
Galvanised steel conduit code 6008:
from Ø16 mm to Ø32 mm
* Stainless steel AISI 304 and 316 conduit
code 6700-6700A: **from Ø16 mm to Ø25 mm**

Curvatubi manuale 6252-1640

Manual conduit bending machine 6252-1640



Curvatubi manuale portatile a tre velocità. Funzionamento mediante la rotazione di una manovella che, grazie ad un gruppo riduttore, rende l'operazione estremamente agevole anche per tubi di Ø40mm e spessore 1,5mm. L'angolo di curvatura è stimato dall'operatore.

L'attrezzatura può essere azionata mediante un trapano, previa l'applicazione di un'apposita frizione sul perno lento della macchina. E' fornita completa di cavalletto pieghevole, cassetta metallica contenente la macchina e gli accessori, matrici e contromatrici di diametro Ø16mm, Ø20mm, Ø25mm, Ø32mm, Ø40mm.

- Peso **17 Kg**
- Capacità di curvatura:
Tubo acciaio zincato cod.6008:
da Ø16 mm a Ø40 mm
*Tubo acciaio INOX AISI 304 e 316
cod. 6700 – 6700A: **da Ø16mm a Ø32mm**

Manual portable conduit bending machine at three speeds.

Operation by means of the rotation of a crank which, thanks to a reduction unit, makes the operation extremely easy even for pipes Ø40mm and thickness 1.5mm. The bending angle is estimated by the operator. The equipment can be operated by a drill, after the application of a special clutch on the machine slow pin. Supplied with folding easel, metal box containing machine and accessories, male and female dies diameter Ø16mm, Ø20mm, Ø25mm, Ø32mm, Ø40mm.

- Weight **17 Kg**
- Bending capacity
Galvanised steel conduit code 6008:
from Ø16 mm to Ø40 mm
*Stainless steel AISI 304 and 316 conduit
code 6700-6700A: **from Ø16 mm to Ø32 mm**

Curvatubi digitale 6253-1640

Digital conduit bending machine 6253-1640



Curvatubi elettrica portatile, con impostazione digitale dell'angolo di curvatura ad arresto automatico, consente la ripetitività della curva con estrema precisione. Funzionamento elettrico monofase con sistema di controllo del sovraccarico. Fornita completa di cavalletto pieghevole, cassetta metallica contenente la macchina e gli accessori, matrici e contromatrici di diametro Ø16mm, Ø20mm, Ø25mm, Ø32mm, Ø40mm.

- Peso **23Kg**
- Capacità di curvatura
Tubo acciaio zincato cod.6008:
da Ø16mm a Ø40mm
*Tubo acciaio INOX AISI 304 e 316 cod.
6700 – 6700A: **da Ø16mm a Ø32mm**

Portable electric conduit bending machine, with digital setting of the bending angle with automatic stop, allows the repetitiveness of the curve with extreme precision. Electrical single-phase operation with overload control system.

Supplied with folding easel, metal box containing machine and accessories, male and female dies diameter Ø16mm, Ø20mm, Ø25mm, Ø32mm, Ø40mm.

- Weight **23 Kg**
- Bending capacity:
Galvanised steel conduit code 6008:
from Ø16 mm to Ø40 mm
*Stainless steel AISI 304 and 316 conduit
code 6700-6700A: **from Ø16 to Ø32 mm**

■ Curvatubi Conduit bending machine

Curvatubi digitale programmabile 6242-1650 / 6242P-1650

Programmable digital conduit bending machine 6242-1650 / 6242P-1650



6242-1650



6242P-1650

Curvatubi elettronica portatile con impostazione dell'angolo di curvatura ad arresto automatico, consente la ripetitività della curva con estrema precisione. Capace di programmare gli angoli di curva e di recupero del materiale, con batteria a tampone per la conservazione dei dati in memoria. Minimi costi di manutenzione, motore monofase ad induzione potente e silenzioso, con sistema di controllo del sovraccarico.

Completa di un sistema di diagnostica dei guasti e di visualizzazione e controllo degli assi.

Possibilità di adattare (optional disponibile solo per cod.6242-1650), un posizionatore a due assi per consentire la produzione in serie di curvaturei su piani differenti.

E' fornita completa di una cassetta metallica contenente gli accessori, matrici e contromatrici di diametro Ø16mm, Ø20mm, Ø25mm, Ø32mm, Ø40mm, Ø50mm. L'attrezzatura cod. 6242-1650 inoltre è comprensiva di un robusto piedistallo munito di ruote.

- Peso codice 6242P-1650 **50 Kg** (solo corpo macchina)
- Capacità di curvatura:
Tubo acciaio zincato cod.6008:
da Ø16mm a Ø50mm
*Tubo acciaio INOX AISI 304 e 316
cod. 6700 – 6700A: **da Ø16mm a Ø40mm**

*** Per un impiego sistematico su tubi in acciaio inox, si consiglia l'utilizzo di matrici in acciaio (non in dotazione standard)**

Portable electronic conduit bending machine, with setting of the bending angle with automatic stop, allows the repetitiveness of the curve with extreme precision. Capable of programming the angles of the curve and the recovery of the material, with buffer battery for the storage of the data in memory.

Minimum maintenance costs, powerful and silent single-phase induction motor, with overload control system.

Supplied with a failures diagnostic system and axes control display.

Possibility to adapt (optional only available for code 6242-1650), a two axes positioner to allow production in series of bends on different planes.

Supplied with a small metal box containing the accessories, male and female dies diameter Ø16mm, Ø20mm, Ø25mm, Ø32mm, Ø40mm, Ø50mm.

The equipment code 6242-1650 also includes a sturdy stand equipped with wheels.

- Weight code 6242-1650 **50 Kg** (only the machine body)
- Bending capacity:
Galvanised steel conduit, code 6008
from Ø16 mm to Ø50 mm
*Stainless steel AISI 304 and 316 conduit
code 6700-6700A **from Ø16 mm to Ø40 mm**

*** For a systematic use on stainless steel conduits, it is recommended to use steel matrices (not supplied as standard)**

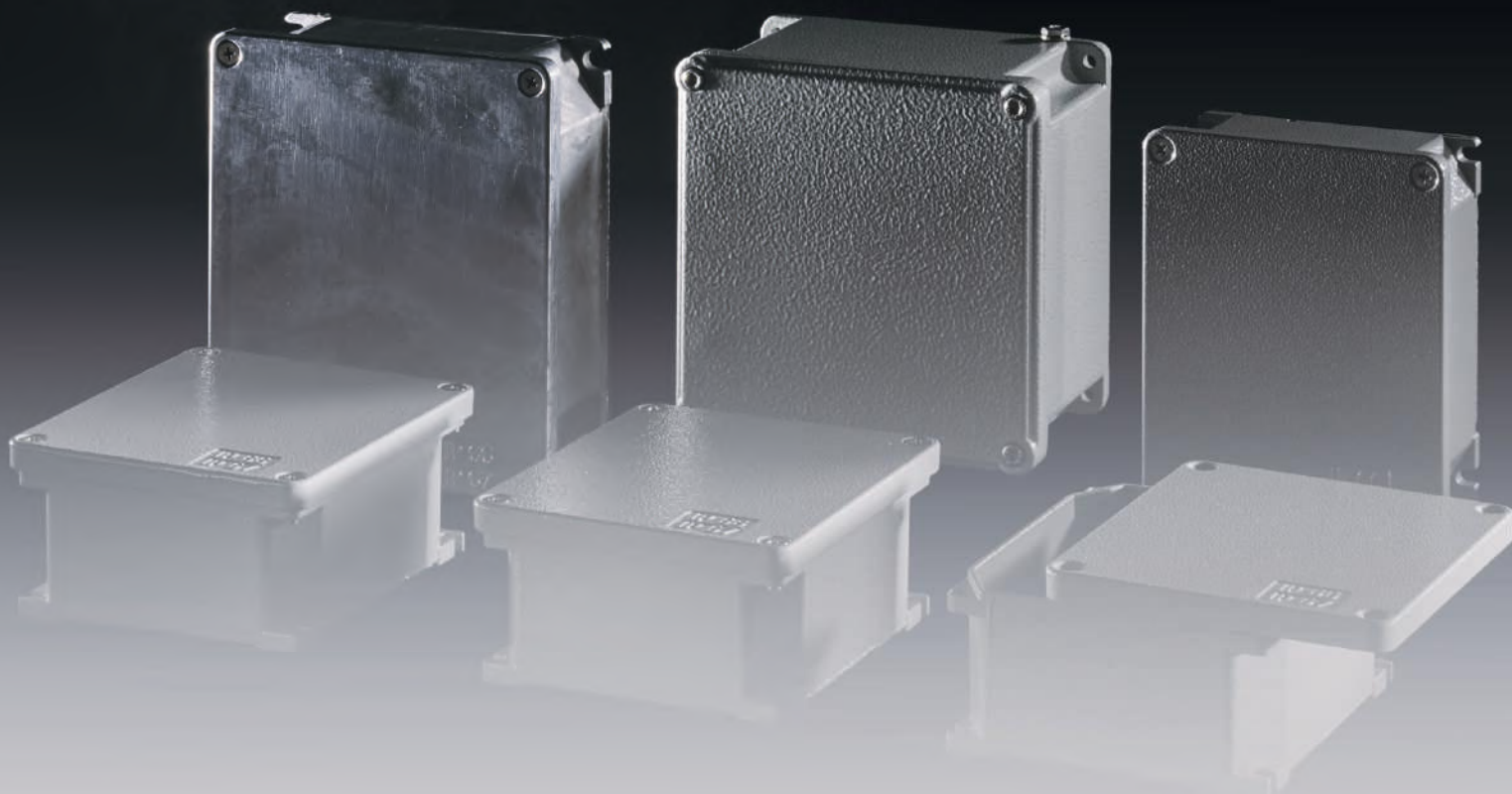

Scatole

Boxes

Scatole di infilaggio	Feeder boxes	118
Scatole di derivazione	Junction boxes	122
Scatole di derivazione - Accessori	Junction boxes - Accessories	124
Scatole	Boxes	126
Scatole equipaggiate	Equipped boxes	128
Scatole per tunnel	Boxes for tunnels	129
Scatole per tunnel - Accessori	Boxes for tunnels - Accessories	132

■ Scatole di infilaggio Feeder boxes

In lega di alluminio a due vie dritte **6030** Aluminium alloy two-way straight **6030**

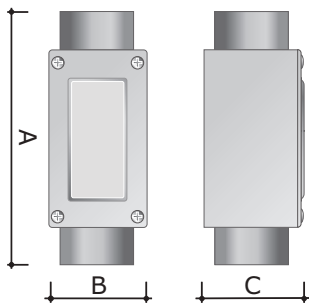

Scatole di infilaggio pressofuse in lega di alluminio UNI EN 1706 (ex UNI 4514) con imbrocchi filettati. Sono prodotte a due, tre e quattro vie, con imbrocchi in asse o perpendicolari, per meglio assecondare le esigenze di installazione.

I coperchi vengono forniti in lamiera di alluminio stampato Tipo A o in lega di alluminio pressofuso Tipo B a seconda dell'articolo richiesto.

Le viti di fissaggio del coperchio e di messa a terra sono prodotte in acciaio zincato, a richiesta possono essere fornite in acciaio inox AISI 304.

Le scatole di infilaggio andranno installate ogni 4 tratte rettilinee di tubo, per evitare rischi di danneggiamento dell'isolamento durante l'infilaggio dei cavi.

Filettature

- Metrico ISO conforme CEI EN 60423
- GAS cilindrico UNI ISO 228

Die-cast feeder boxes in aluminium alloy UNI EN 1706 (ex UNI 4514) with threaded inlets.

Produced in two, three and four ways, with inlets in axis or perpendicular, to better meet the needs of installation.

The covers are supplied in moulded aluminium sheet type A or die-cast aluminium alloy Type B depending on the article requested.

The cover and earthing mounting bolts are produced in galvanized steel, on request they can be supplied in stainless steel AISI 304.

The feeder boxes will be installed after every 4 straight sections of conduit, to avoid the risk of damaging the insulation during the slipping of the cables.

Threads

- ISO metric IEC EN 60423
- UNI ISO 228 GAS cylindrical.



IP66

Tipo A Coperchio stampato
A type Moulded cover



IP65

Tipo B Coperchio pressofuso
B type Die-cast cover

Filettatura Metrica Metric thread

CODICE CODE	FILETTO THREAD F	DIMENSIONI mm DIMENSIONS mm			TIPO TYPE	CONFEZIONE PACKAGING
		A	B	C		
6030-16A	M 16x1,5	118	51	42	A	1
6030-20	M 20x1,5	118	51	42	A	1
6030-25	M 25x1,5	118	51	42	A	1
6030-32A	M 32x1,5	146	45	57	B	1
6030-40	M 40x1,5	171	62	71	B	1
6030-50	M 50x1,5	171	62	71	B	1

Filettatura Gas ISO 228 Gas ISO 228 thread

CODICE CODE	FILETTO THREAD F	DIMENSIONI mm DIMENSIONS mm			TIPO TYPE	CONFEZIONE PACKAGING
		A	B	C		
6030-16N	3/8"	118	51	42	A	1
6030-12N	1/2"	118	51	42	A	1
6030E12	1/2"	123	40	48	B	1
6030E34	3/4"	123	40	48	B	1
6030-34	3/4"	118	51	42	A	1
6030-1	1"	146	45	57	B	1
6030-114	1" 1/4	171	62	71	B	1
6030-112	1" 1/2	171	62	71	B	1
6030-2	2"	204	76	83	B	1
6030-212	2" 1/2	257	107	122	B	1
6030-03*	3"	257	107	122	B	1
6030-4*	4"	314	133	148	B	1

*A richiesta/On request

■ Scatole di infilaggio Feeder boxes

In lega di alluminio a due vie una verso il basso 603B Two-way aluminium alloy, one downwards 603B



Tipo B Coperchio pressofuso
Type B Die-cast cover

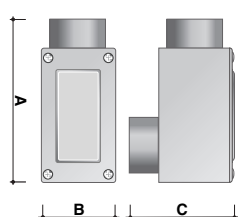

IP65

Filettatura Gas ISO 228 Gas ISO 228 thread

CODICE CODE	FILETTO THREAD F	DIMENSIONI mm DIMENSIONS mm			TIPO TYPE	CONFEZIONE PACKAGING
		A	B	C		
603B-12	1/2"	117	40	65	B	1
603B-34	3/4"	117	40	65	B	1
603B-01	1"	137	45	78	B	1
603B-114	1" 1/4	163	62	89	B	1
603B-112	1" 1/2	163	62	89	B	1
603B-02	2"	190	76	108	B	1
603B-212	2" 1/2	238	107	150	B	1
603B-03*	3"	238	107	150	B	1
603B-04*	4"	300	133	185	B	1

*A richiesta / On request

In lega di alluminio a due vie a "L" destre 603D Aluminium alloy two-ways "L" right 603D



Tipo B Coperchio pressofuso
Type B Die-cast cover

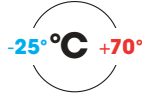
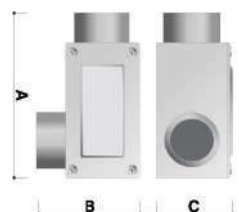

IP65

Filettatura Gas ISO 228 Gas ISO 228 thread

CODICE CODE	FILETTO THREAD F	DIMENSIONI mm DIMENSIONS mm			TIPO TYPE	CONFEZIONE PACKAGING
		A	B	C		
603D-12	1/2"	117	51	48	B	1
603D-34	3/4"	117	51	48	B	1
603D-01	1"	137	61	57	B	1
603D-114	1" 1/4	163	76	71	B	1
603D-112	1" 1/2	163	76	71	B	1
603D-02	2"	190	94	83	B	1
603D-212	2" 1/2	238	135	122	B	1
603D-03*	3"	238	135	122	B	1
603D-04*	4"	300	162	148	B	1

*A richiesta / On request

In lega di alluminio a due vie a "L" sinistre 603S Aluminium alloy two-ways "L" left 603S



Tipo B Coperchio pressofuso
Type B Die-cast cover

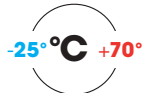
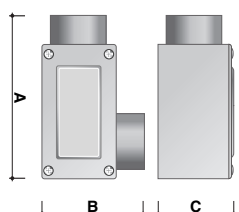

IP65

Filettatura Gas ISO 228 Gas ISO 228 thread

CODICE CODE	FILETTO THREAD F	DIMENSIONI mm DIMENSIONS mm			TIPO TYPE	CONFEZIONE PACKAGING
		A	B	C		
603S-12	1/2"	117	53	48	B	1
603S-34	3/4"	117	53	48	B	1
603S-01	1"	137	63	57	B	1
603S-114	1" 1/4	163	78	71	B	1
603S-112	1" 1/2	163	78	71	B	1
603S-02	2"	190	96	83	B	1
603S-212	2" 1/2	238	138	122	B	1
603S-03*	3"	238	138	122	B	1
603S-04*	4"	300	166	148	B	1

*A richiesta / On request

■ Scatole di infilaggio Feeder boxes

In lega di alluminio a tre vie a "T" 6330 Aluminium alloy three-ways "T" 6330



IP66

Tipo A Coperchio stampato
A type Moulded cover



IP65

Tipo B Coperchio pressofuso
Type B Die-cast cover

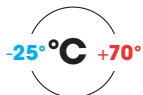
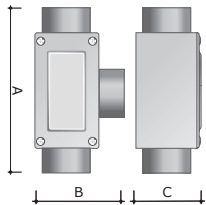

Filettatura Metrica Metric thread

CODICE CODE	FILETTO THREAD F	DIMENSIONI mm DIMENSIONS mm			TIPO TYPE	CONFEZIONE PACKAGING
		A	B	C		
6330-16A	M 16x1,5	118	67	42	A	1
6330-20	M 20x1,5	118	67	42	A	1
6330-25	M 25x1,5	118	67	42	A	1
6330-32A	M 32x1,5	146	63	57	B	1
6330-40	M 40x1,5	171	78	71	B	1
6330-50	M 50x1,5	171	78	71	B	1

Filettatura Gas ISO 228 Gas ISO 228 thread

CODICE CODE	FILETTO THREAD F	DIMENSIONI mm DIMENSIONS mm			TIPO TYPE	CONFEZIONE PACKAGING
		A	B	C		
6330-16	3/8"	118	67	42	A	1
6330-12	1/2"	118	67	42	A	1
6330E12	1/2"	123	53	48	B	1
6330E34	3/4"	123	53	48	B	1
6330-34	3/4"	118	67	42	A	1
6330-1	1"	146	63	57	B	1
6330-114	1" 1/4	171	78	71	B	1
6330-112	1" 1/2	171	78	71	B	1
6330-2	2"	204	96	83	B	1
6330-212	2" 1/2	257	138	122	B	1
6330-3*	3"	257	138	122	B	1
6330-4*	4"	314	166	148	B	1

*A richiesta / On request

In lega di alluminio a tre vie a "T" con una sul fondo 633B Aluminium alloy three-ways "T" with one on the bottom 633B



Tipo B Coperchio pressofuso
Type B Die-cast cover

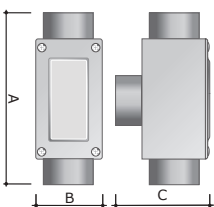

IP65

Filettatura Gas ISO 228 Gas ISO 228 thread

CODICE CODE	FILETTO THREAD F	DIMENSIONI mm DIMENSIONS mm			TIPO TYPE	CONFEZIONE PACKAGING
		A	B	C		
633B-12	1/2"	123	40	65	B	1
633B-34	3/4"	123	40	65	B	1
633B-01	1"	146	45	78	B	1
633B-114	1" 1/4	171	62	89	B	1
633B-112	1" 1/2	171	62	89	B	1
633B-02	2"	204	76	108	B	1
633B-212	2" 1/2	257	107	150	B	1
633B-03*	3"	257	107	150	B	1
633B-04*	4"	314	133	185	B	1

*A richiesta / On request

■ Scatole di infilaggio Feeder boxes

In lega di alluminio a quattro vie **6430** Aluminium alloy four-ways **6430**



IP66

Tipo A Coperchio stampato
A type Moulded cover



IP65

Tipo B Coperchio pressofuso
Type B Die-cast cover

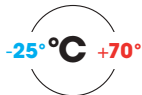
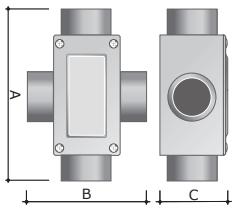

Filettatura Metrica Metric thread

CODICE CODE	FILETTO THREAD F	DIMENSIONI mm DIMENSIONS mm			TIPO TYPE	CONFEZIONE PACKAGING
		A	B	C		
6430-16A	M 16x1,5	118	83	42	A	1
6430-20	M 20x1,5	118	83	42	A	1
6430-25	M 25x1,5	118	83	42	A	1
6430-32A	M 32x1,5	146	81	57	B	1
6430-40	M 40x1,5	171	96	71	B	1
6430-50	M 50x1,5	171	96	71	B	1

Filettatura Gas ISO 228 Gas ISO 228 thread

CODICE CODE	FILETTO THREAD F	DIMENSIONI mm DIMENSIONS mm			TIPO TYPE	CONFEZIONE PACKAGING
		A	B	C		
6430-16	3/8"	118	83	42	A	1
6430-12	1/2"	118	83	42	A	1
6430E12	1/2"	123	68	48	B	1
6430E34	3/4"	123	68	48	B	1
6430-34	3/4"	118	83	42	A	1
6430-1	1"	146	81	57	B	1
6430-114	1" 1/4	171	96	71	B	1
6430-112	1" 1/2	171	96	71	B	1
6430-2	2"	204	118	83	B	1
6430-212	2" 1/2	257	164	122	B	1
6430-3*	3"	257	164	122	B	1
6430-4*	4"	314	196	148	B	1

*A richiesta / On request

In lega di alluminio a due vie a 90° **603V** Aluminium alloy two-ways 90° **603V**



Tipo B Coperchio pressofuso
Type B Die-cast cover

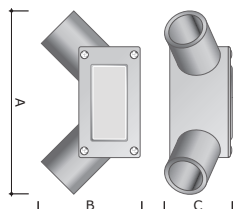

IP65

Filettatura Gas ISO 228 Gas ISO 228 thread

CODICE CODE	FILETTO THREAD F	DIMENSIONI mm DIMENSIONS mm			TIPO TYPE	CONFEZIONE PACKAGING
		A	B	C		
603V-12	1/2"	130	64	44	B	1
603V-34	3/4"	130	64	44	B	1
603V-01	1"	148	73	50	B	1
603V-112	1" 1/2	182	103	71	B	1
603V-02	2"	211	118	83	B	1
603V-212	2" 1/2	310	156	115	B	1

■ Scatole di derivazione

Junction boxes

In lega di alluminio verniciato **6530**

Aluminium alloy painted **6530**

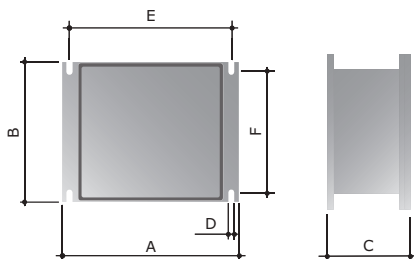

Scatole di derivazione realizzate in lega di alluminio EN AB 46100 (ex. UNI 5076) secondo norme UNI EN 1676, verniciate a forno con resine poliesteri.

Sono fornite con pareti chiuse e coperchio avvolgente, la guarnizione in **espanso poliuretano** già alloggiata nella sede del coperchio, ne assicura la tenuta stagna. Complete di viti in acciaio per il fissaggio del coperchio e di n.1 kit di messa a terra cod 66950074A, sono predisposte con i masselli per messa a terra e per l'applicazione di piastre, supporti ed accessori. Il fissaggio a parete avviene mediante le staffe esterne incorporate nella base. Colore grigio RAL 7040 bucciato.

Ogni scatola è confezionata singolarmente. I kit per i fissaggi interni sono disponibili a richiesta.

Per applicazioni particolari è necessario specificare l'impiego in fase d'ordine.

- Standard **CEI EN 60670 e CEI 23-48**
- Grado IP EN 60529 **IP66/IP67/IP69**
- Resistenza agli urti CEI EN 62262 **IK08 a 20°C**
- Resistenza in nebbia salina ASTM B117 **500 ore (con intaglio della superficie)**
- Resistenza in nebbia salina ISO 9227 **720 ore**

Junction boxes made of aluminium alloy EN AB 46100 (ex. UNI 5076) according to UNI EN 1676, oven painted with polyester resins.

Supplied with closed walls and wrapping cover, the gasket in **expanded polyurethane** already housed in the seat of the cover, ensures the tightness.

Complete with stainless steel AISI 304 screws for securing the cover and n.1 grounding kit code 66950074A, are arranged with the ingots for grounding and for the application of plates, supports and accessories. The wall mounting takes place through the external brackets incorporated in the base. Colour Grey RAL 7040 textured.

Each unit is individually packaged.

The kits for inner mountings are available on request.

For special applications it is necessary to specify the use at the time of the order.

- Standards **IEC EN 60670 and IEC 23-48**
- IP degree EN 60529 **IP66/IP67/IP69**
- Impact resistance CEI EN 50102 **IK08 at 20°C**
- Resistance to saline mist ASTM B117 **500 hours (with notch of the surface)**
- Resistance to saline mist ISO 9227 **720 hours**



**IP66
IP67
IP69**



CODICE CODE	SIZE	DIMENSIONE INTERNA mm INTERNAL DIMENSIONS mm				DIMENSIONE ESTERNA mm EXTERNAL DIMENSIONS mm			FISSAGGI A PARETE mm WALL FIXINGS mm			CONFEZIONE PACKAGE pz / pcs.
		A	B	C	base piastra plate base	A	B	C	D	E	F	
65300	0	90	90	53	/	100	100	59	6,0	80	86	32
65301	1	128	103	55	45	140	115	60	6,0	120	100	24
65302	2	154	129	58	48	166	142	64	7,0	144	125	16
65303	3	178	155	74	64	192	168	80	6,5	168	149	12
65304	4	239	202	85	75	253	217	93	9,0	226	196	6
65305	5	294	244	114	104	314	264	122	9,0	275	236	2
65306	6	392	298	144	127	410	315	153	9,0	367	283	1

CODICE CODE	DESCRIZIONE DESCRIPTION
66950074A	Kit per fissaggi interni e messa a terra (n° 2 viti 4x8 mm + n° 2 inserti di fissaggio) Kit for inner mountings and earthing (no. 2 screws 4x8 mm + no. 2 mounting inserts)

Derivazioni consigliate per singolo lato

Recommended junctions for single side

FILETTO THREAD	65300		65301		65302		65303		65304		65305		65306	
	A	B	A	B	A	B	A	B	A	B	A	B	A	B
M16	2	2	3	2	3	3	4	4	5	5	6	6	9	7
M20	2	1	2	2	3	2	3	3	5	4	5	5	8	6
M25	1	1	2	2	2	2	3	3	4	4	4	4	6	5
M32	1	1	1	1	2	1	2	2	3	3	4	3	5	4
M40	-	-	-	-	-	-	2	2	2	2	3	3	4	3
M50	-	-	-	-	-	-	1	1	2	2	2	2	4	3
M63	-	-	-	-	-	-	-	-	2	1	2	2	3	2



Scatole di derivazione

Junction boxes

In lega di alluminio verniciato 653S

Cast aluminium painted 653S

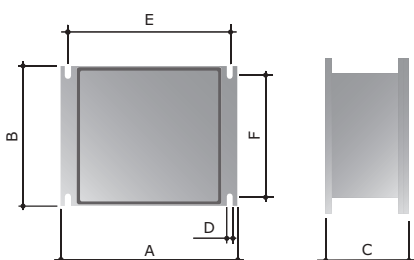

-60°C +150°

IP66
IP67
IP69



Scatole di derivazione realizzate in lega di alluminio EN AB 46100 (ex. UNI 5076) secondo norme UNI EN 1676, verniciate a forno con resine poliesteri.

Sono fornite con pareti chiuse e coperchio avvolgente, la **guarnizione in silicone** già alloggiata nella sede del coperchio, ne assicura la tenuta stagna. Complete di viti in acciaio per il fissaggio del coperchio e di n.1 kit di messa a terra cod 66950074A, le scatole sono predisposte con i masselli per messa a terra e per l'applicazione di piastre, supporti ed accessori. Il fissaggio a parete avviene mediante le staffe esterne incorporate nella base.

Colore grigio RAL 7037 bucciato.

Ogni scatola è confezionata singolarmente. I kit per i fissaggi interni sono disponibili a richiesta.

Per applicazioni particolari è necessario specificare l'impiego in fase d'ordine.

- Standard **CEI EN 60670 e CEI 23-48**
- Grado IP EN 60529 **IP66/IP67/IP69**
- Resistenza agli urti CEI EN 62262 **IK08 a 20°C**
- Resistenza in nebbia salina ASTM B117 **500 ore (con intaglio della superficie)**
- Resistenza in nebbia salina ISO 9227 **720 ore**

Junction boxes made of aluminium alloy EN AB 46100 (ex. UNI 5076) according to UNI EN 1676, oven painted with polyester resins.

Supplied with closed walls and a wrapping cover, the gasket in silicone already housed in the seat of the cover, ensures the tightness. Complete with stainless steel AISI 304 screws for securing the cover and n.1 grounding kit code 66950074A, the boxes are provided with the ingots for grounding and the application of plates, supports, and accessories. The wall mounting takes place through the external brackets incorporated in the base.

Colour Grey RAL 7037 textured.

Each unit is individually packaged.

The kits for inner mountings are available on request.

For special applications, it is necessary to specify the use at the time of the order.

- Standard **IEC EN 60670 and IEC 23-48**
- IP degree EN 60529 **IP66/IP67/IP69**
- Impact resistance CEI EN 50102 **IK08 at 20°C**
- Resistance to saline mist ASTM B117 **500 hours (with notch of the surface)**
- Resistance to saline mist ISO 9227 **720 hours**

CODICE CODE	SIZE	DIMENSIONE INTERNA mm INTERNAL DIMENSIONS mm				DIMENSIONE ESTERNA mm EXTERNAL DIMENSIONS mm			FISSAGGI A PARETE mm WALL FIXINGS mm			CONFEZIONE PACKAGE pz / pcs.
		A	B	C	base piastra plate base	A	B	C	D	E	F	
653S00	0	90	90	53	/	100	100	59	6,0	80	86	32
653S01	1	128	103	55	45	140	115	60	6,0	120	100	24
653S02	2	154	129	58	48	166	142	64	7,0	144	125	16
653S03	3	178	155	74	64	192	168	80	6,5	168	149	12
653S04	4	239	202	85	75	253	217	93	9,0	226	196	6
653S05	5	294	244	114	104	314	264	122	9,0	275	236	2
653S06	6	392	298	144	127	410	315	153	9,0	367	283	1

CODICE CODE	DESCRIZIONE DESCRIPTION
66950074A	Kit per fissaggi interni e messa a terra (n° 2 viti 4x8 mm + n° 2 inserti di fissaggio) Kit for inner mountings and earthing (no. 2 screws 4x8 mm + no. 2 mounting inserts)

Derivazioni consigliate per singolo lato

Recommended junctions for single side

FILETTO THREAD	653S00		653S01		653S02		653S03		653S04		653S05		653S06	
	A	B	A	B	A	B	A	B	A	B	A	B	A	B
M16	2	2	3	2	3	3	4	4	5	5	6	6	9	7
M20	2	1	2	2	3	2	3	3	5	4	5	5	8	6
M25	1	1	2	2	2	2	3	3	4	4	4	4	6	5
M32	1	1	1	1	2	1	2	2	3	3	4	3	5	4
M40	-	-	-	-	-	-	2	2	2	2	3	3	4	3
M50	-	-	-	-	-	-	1	1	2	2	2	2	4	3
M63	-	-	-	-	-	-	-	-	2	1	2	2	3	2

■ Scatole di derivazione - Accessori

Junction Boxes - Accessories

Piastre di fondo

Plate bases

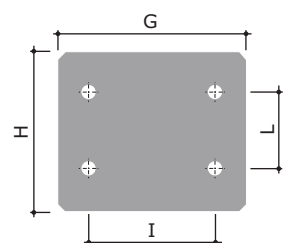

Sono prodotte da lamiera di acciaio zincato, forate e complete di viti per il fissaggio alla base (n.2 Kit per fissaggi interni cod. 66950074A).

Sono utilizzate per l'applicazione di apparecchiature e morsettiere all'interno delle scatole.

Made of galvanized steel sheet, pierced and complete with screws for fixing to the base (n.2 Kit for inner mountings code 66950074A).

They are used for the application of equipment and terminal blocks inside the boxes.

CODICE CODE	RIFERIMENTO SCATOLA BOX REFERENCE SIZE	DIMENSIONI mm DIMENSIONS mm			
		G	H	I	L
653011	1	122	82	107	66
653012	2	133	109	121	98
653013	3	165	124	153	112
653014	4	206	172	188	153
653015	5	254	210	238	198
653016	6	349	260	333	248

Guida DIN

DIN guide



Diagonale
Diagonal



Orizzontale
Horizontal



Sono ricavate da guida con profilo omega EN 50022, forate ed opportunamente sagomate.

L'impiego del kit guida evita l'utilizzo della piastra di fondo.

Sono fornite complete di n.1 Kit per fissaggi interni cod. 66950074A.

Produced with omega EN 50022 profile, pierced and suitably shaped. The use of the guide kit prevents the use of the plate base.

Supplied complete with n.1 Kit for inner mountings code 66950074A.

Diagonale Diagonal

CODICE CODE	RIFERIMENTO SCATOLA BOX REFERENCE SIZE
653020	0
653021	1
653022	2
653023	3
653024	4
653025	5
653026	6

Orizzontale Horizontal

CODICE CODE	RIFERIMENTO SCATOLA BOX REFERENCE SIZE
-	0
653021H	1
653022H	2
653023H	3
653024H	4
653025H	5
653026H	6

■ Scatole di derivazione Junction boxes

In lega di alluminio verniciato **65310**

Aluminium alloy painted **65310**



Scatole di derivazione realizzate in lega di alluminio pressofuso EN AB 44100 secondo norme UNI EN 1676, verniciate a forno con resine epossidiche. Sono fornite con pareti chiuse e coperchio avvolgente. Complete di viti in acciaio inox per il fissaggio del coperchio e per la messa a terra interna ed esterna, le scatole sono predisposte con i masselli per l'applicazione di piastre, supporti ed accessori. Il fissaggio a parete avviene mediante le staffe esterne incorporate nella base. Continuità elettrica garantita. Le piastre per i fissaggi interni si producono a richiesta. Si realizzano forature ed equipaggiamenti su specifica del cliente. Grigio RAL 7035 metallizzato bucciato

Junction boxes made of die cast aluminium alloy EN AB 44100 according to UNI EN 1676, oven painted with epoxy resins. Supplied with walls closed and wrapping cover. Complete with stainless steel screws for the fastening of the cover and for indoor and outdoor earthing, are provided with the ingots for the application of plates, supports and accessories. The wall mounting takes place through the external brackets incorporated in the base. Electrical continuity guaranteed. Plates for inner mountings are produced on request. We provide holes and equipment according to the specification of the customer. Grey RAL 7035 metallized textured

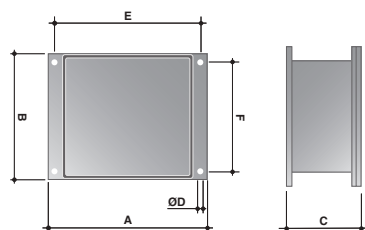

-30°C +100°C

IP66



- Standard CEI EN 60670 e CEI 23-48
- Grado IP EN 60529 IP66

- Standards IEC EN 60670 and IEC 23-48
- IP degree EN 60529 IP66

CODICE CODE	DIMENSIONE INTERNA mm INTERNAL DIMENSIONS mm			DIMENSIONE ESTERNA mm EXTERNAL DIMENSIONS mm			FISSAGGI A PARETE mm WALL FIXINGS mm			CONFEZIONE PACKAGE pz / pcs.
	A	B	C base piastra base plates	A	B	C	D	E	F	
65310	78	78	52	90	90	75	6,5	74	74	1
65311	98	98	65	110	110	85	6,5	94	94	1
65312	135	135	79	147	147	100	6,5	131	131	1
65313	289	131	92	305	147	110	7,0	285	127	1
65314	289	212	92	305	230	110	7,0	285	210	1
65315	289	212	172	305	230	190	7,0	285	210	1
65316	454	289	175	470	305	195	7,0	450	285	1
65317	597	282	156	620	305	195	6,5	600	285	1

In lega di alluminio nichel ramato **65300N**

Aluminium copper-plated nickel alloy **65300N**



Scatole di derivazione realizzate in lega di alluminio EN AB 46100 (ex. UNI 5076) secondo norme UNI EN 1676 e sottoposte ai trattamenti galvanici di nichelatura e ramatura. L'elevato spessore dei rivestimenti elettrolitici, conferisce una buona resistenza agli agenti atmosferici ed un aspetto estetico analogo ai particolari realizzati in leghe di rame, incluso il fenomeno di invecchiamento. Vengono fornite con pareti chiuse e coperchio avvolgente e la guarnizione ne assicura la tenuta stagna. Complete di viti ramate in acciaio inox AISI 304 e di n.1 kit di messa a terra cod 66950074A. Predisposte con i masselli per la messa a terra e per l'applicazione di piastre, supporti ed accessori. Il fissaggio a parete avviene mediante le staffe esterne, incorporate nella base della scatola.

Junction boxes made of aluminium alloy EN AB 46100 (ex. UNI 5076) under UNI EN 1676 and subjected to nickel and copper galvanic treatments. The high thickness of the electrolytic coatings gives good resistance to atmospheric agents and an appearance similar to parts realized in copper alloys, including ageing. Supplied with walls closed and wrapping cover and the gasket ensures the tightness. Complete with auburn screws in stainless steel AISI 304 and n.1 grounding kit code 66950074A. Prepared with ingots for grounding and the application of plates, supports, and accessories. The wall mounting takes place through external brackets, incorporated in the base of the box.

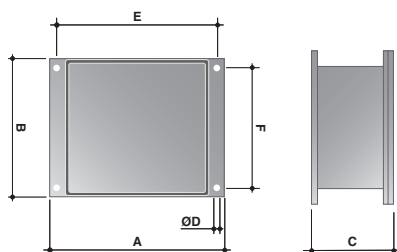

-30°C +100°C

IP66
IP67

- Standard CEI EN 60670 e CEI 23-48
- Grado IP EN 60529 IP66/IP67/IP69
- Resistenza agli urti CEI EN 50102 IK 08

- Standard IEC EN 60670 and IEC 23-48
- IP degree IEC EN 60529 IP66/IP67/IP69
- Impact resistance IEC EN 50102 IK 08

CODICE CODE	DIMENSIONE INTERNA mm INTERNAL DIMENSIONS mm			DIMENSIONE ESTERNA mm EXTERNAL DIMENSIONS mm			FISSAGGI A PARETE mm WALL FIXINGS mm			CONFEZIONE PACKAGE pz / pcs.
	A	B	C	A	B	C	D	E	F	
65300N	90	90	53	100	100	59	6	80	86	1

Scatole Boxes

In acciaio inox **6410**
Stainless steel **6410**

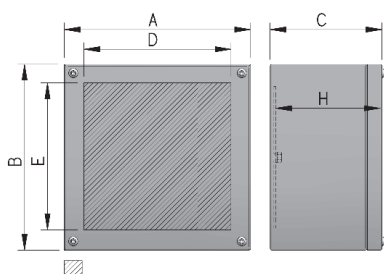

Sono prodotte in acciaio inox AISI 304 satinato (X5CrNi1810 1.4301 UNI EN 10088-1) ricavate da un foglio di lamiera di acciaio inox 1,2 mm. Questa viene tranciata, stampata e saldata in atmosfera inerte per evitare fenomeni di corrosione.

La guarnizione in gomma neoprenica espansa, antiolio e autoestinguente, già alloggiata nel coperchio, garantisce la tenuta stagna IP66. Continuità elettrica garantita. Sono complete di viti antiperdenti per il fissaggio del coperchio e predisposte per la messa a terra come da normative vigenti. Sul fondo della scatola sono applicati prigionieri M6 inox per il fissaggio di profili portanti o delle piastre di fondo (eccetto cod.6410E01 e cod.6411E01).

Kit per il fissaggio a parete **cod.6412F** da richiedere separatamente e facilmente applicabile praticando un foro Ø8mm sul fondo della scatola; il grado IP è garantito dalle guarnizioni di tenuta incluse nel kit.

- Grado IP CEI EN 60529 **IP66/IP69K**
- Resistenza alla corrosione **Alta**

Art. 6410S..EX producibile a richiesta -
SERIE DS-EX in accordo alla direttiva ATEX
2014/34/CE

Serie DE Zona 2-22

Serie DS Zona 1-21 2-22

Prodotto in acciaio inox AISI 316L a richiesta

Made of AISI 304 satin stainless steel (X5CrNi1810 1.4301 UNI EN 10088-1) from a stainless steel sheet of 1.2 mm.

This is sheared, pressed and welded in an inert atmosphere to avoid corrosion phenomena.

The expanded neoprene rubber seal, anti-oil and self-extinguishing, already housed in the cover ensures IP66 tightness.

Electrical continuity guaranteed.

Complete with screws for fixing the cover and equipped for earthing as per current regulations.

On the bottom of the box, there are applied stainless steel M6 studs for fixing supporting profiles or bottom plates (except code 6410E01 and code 6411E01).

Wall mounting kit **code 6412F** to be requested separately and can be easily applied by drilling a Ø8mm hole on the bottom of the box; the IP level is guaranteed by the seals included in the kit.

- IP degree IEC EN 60529 **IP66/IP69K**
- Corrosion resistance **High**

Art. 6410S..EX manufactured on request -
SERIES DS-EX in accordance with ATEX
Directive 2014/34/CE

Serie DE Area 2-22

Serie DS Zone 1-21 2-22

Manufactured in stainless steel AISI 316L on request

-50°C +70°C

**IP66
IP69K**

File n° E237618



4X, 12, 1, 4 Standard UL508A -
UL50 - Standard 250
(SOLO MOD. DS - Cod.6410S)



DE	AISI 304	CODICE AISI 316L	CODE PIASTRA DI FONDO BOTTOM PLATE	DIMENSIONI mm DIMENSIONS mm					
				A	B	C	D	E	H
	6410E01	6410E01-S*	-	82	82	86	68	68	76
	6410E02	6410E02-S*	6410P02	142	82	86	128	68	76
	6410E03	6410E03-S*	6410P03	202	82	86	188	68	76
	6410E04	6410E04-S*	6410P04	132	152	86	118	138	76

DS	AISI 304	CODICE AISI 316L	CODE PIASTRA DI FONDO BOTTOM PLATE	DIMENSIONI mm DIMENSIONS mm					
				A	B	C	D	E	H
	6410S06	6410S06-S*	6410P06	190	150	125	150	110	115
	6410S09	-	6410P09	210	190	125	170	150	115
	-	6410S10-S*	6410P10	210	210	125	170	170	115
	6410S12	6410S12-S*	6410P12	270	190	125	230	150	115
	6410S16	6410S16-S*	6410P16	270	240	125	230	200	115
	6410S20	6410S20-S*	6410P20	320	230	150	280	190	140
	6410S25	6410S25-S*	6410P25	320	280	150	280	240	140
	-	6410S40-S*	6410P40	400	200	150	360	160	140
	6410S43	-	6410P43	400	300	150	360	260	140

*A richiesta/On request

Kit Fissaggio a parete Wall mounting kit

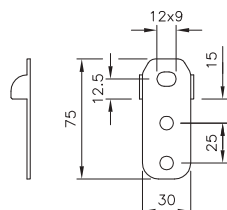

CODICE CODE	DESCRIZIONE DESCRIPTION	CONFEZIONE PACKAGE pz / pcs.
6412F	Kit fissaggio a parete (fino a cod.6410S25) Wall mounting Kit (up to code 6410S25)	2
6400SP025	Kit fissaggio a parete (da cod.6410S40) Wall mounting Kit (up to code 6410S40)	4

Scatole Boxes

Pulsantiera in acciaio inox 6411 Stainless steel push-buttons 6411

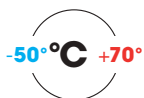
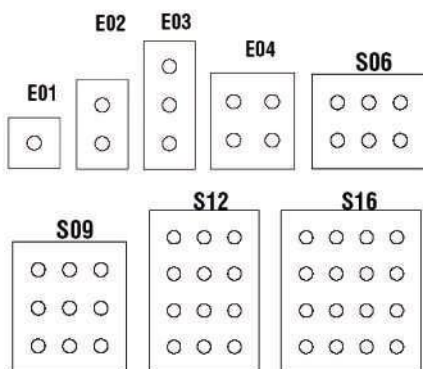
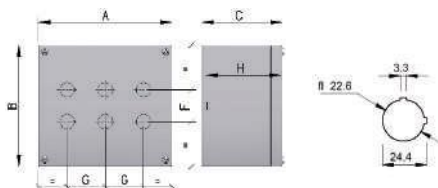

File n° E237618



4X, 12, 1, 4 Standard UL508A -
UL50 - Standard 250
Mod. PS



Sono prodotte in acciaio inox AISI 304 satinato (X5CrNi1810 1.4301 UNI EN 10088-1) ricavate da un foglio di lamiera di acciaio inox 1,2 mm. Questa viene tranciata, stampata e saldata in atmosfera inerte per evitare fenomeni di corrosione.

La guarnizione in gomma neoprenica espansa, antiolio ed autoestinguente, già alloggiata nel coperchio, garantisce la tenuta stagna IP66.

Sono complete di viti antiperdenti per il fissaggio del coperchio e predisposte per la messa a terra come da normative vigenti. Sul fondo della scatola sono applicati prigionieri M6 inox per il fissaggio di profili portanti o delle piastre di fondo (eccetto cod.6411E01).

Fori sul coperchio per pulsantiera normalizzata Ø22,5mm.

- Grado IP CEI EN 60529 **IP66/IP69K**
- Continuità elettrica garantita
- Resistenza alla corrosione **Alta**

Art. 6411..EX producibile a richiesta -SERIE DS-EX in accordo alla direttiva ATEX 2014/30/CE Zone 2-22.

Prodotto in acciaio inox AISI 316 a richiesta

Made of AISI 304 satin stainless steel (X5CrNi1810 1.4301 UNI EN 10088-1) from a stainless steel sheet of 1.2 mm.

This is sheared, pressed and welded in an inert atmosphere to avoid corrosion phenomena.

The expanded neoprene rubber seal, anti-oil and self-extinguishing, already housed in the cover, ensures IP66 tightness.

Complete with screws for fixing the cover and equipped for earthing as per current regulations.

On the bottom of the box there are applied stainless steel M6 studs for fixing supporting profiles or bottom plates (except code 6411E01).

Holes on the cover for normalized push-button 22.5Ø mm.

- IP degree IEC EN 60529 **IP66/IP69K**
- Electrical continuity guaranteed
- Corrosion resistance **High**

Art. 6411..EX manufactured on request -SERIES DS-EX in accordance with ATEX Directive 2014/30/CE Zone 2-22.

Manufactured in stainless steel AISI 316 on request

	CODICE CODE	PIASTRA DI FONDO BOTTOM PLATE	DIMENSIONI mm DIMENSIONS mm					
			A	B	C	F	G	H
PE	6411E01	-	82	82	86	-	-	80
	6411E02	6410P02	142	82	86	-	60	80
	6411E03	6410P03	202	82	86	-	60	80
	6411E04	6410P04	132	152	86	60	60	80

	CODICE CODE	PIASTRA DI FONDO BOTTOM PLATE	DIMENSIONI mm DIMENSIONS mm					
			A	B	C	F	G	H
PS	6411S06	6410P06	190	150	100	60	50	93
	6411S09	6410P09	210	190	100	50	60	93
	6411S12	6410P12	270	190	100	50	60	93
	6411S16	6410P16	270	240	100	50	60	93

Kit Fissaggio a parete Wall fixing kit

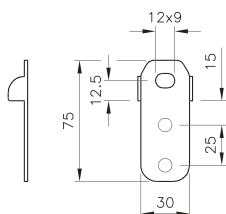

Applicabili praticando un foro Ø8mm sul fondo della scatola; grado IP garantito dalle guarnizioni di tenuta incluse nel kit. Su richiesta si producono in acciaio inox AISI 316.

Can be easily applied by drilling a Ø8mm hole on the bottom of the box; the IP level is guaranteed by the seals included in the kit. On request we produce them in stainless steel AISI 316.

CODICE CODE	CONFEZIONE PACKAGE
	pz / pcs.
6412F	2

■ Scatole equipaggiate Equipped boxes

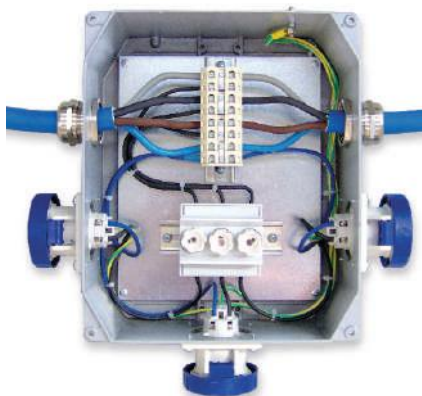

DKC Linea Cosmec produce e vende da oltre 20 anni un'ampia gamma di cassette di derivazione metalliche, normalmente fornite con pareti chiuse.

DKC Linea Cosmec è in grado di fornire scatole forate a disegno o equipaggiate con pressacavi, prese, piastre, barre DIN, morsettiere, cablaggi, ecc.

Sulla base di specifiche esigenze possiamo suggerire soluzioni e realizzare campionature.

For over 20 years, DKC's Cosmec Line has been producing and selling a wide range of metal junction boxes, normally supplied with closed walls.

DKC Cosmec Line can also provide perforated boxes according to customer's drawing or equipped with cable glands, sockets, plates, DIN bars, junction blocks, wiring, etc.

On the basis of the specific needs of the customer, we can suggest solutions and provide samples.



■ Scatole per tunnel Boxes for tunnels

Tipologie e caratteristiche Types and Characteristics



Nell'ambito dell'impiantistica elettrica per le gallerie, l'esigenza di sicurezza e affidabilità dei materiali è fondamentale. Per tali motivi DKC propone una serie di cassette di derivazione metalliche testate presso istituti certificati al fine di comprovare l'idoneità dei componenti a garantire la continuità elettrica in caso d'incendio.

Omologazione FIRE PROOF

L'omologazione FIRE PROOF garantisce il superamento delle prove di funzionamento previste dalle linee guida ANAS riferite agli impianti di illuminazione, sicurezza ed estrazione fumi. La prova richiesta dall'ANAS, conosciuta come RESISTENZA AL FUOCO (novembre 2009), consiste nel portare l'ambiente circostante la cassetta di derivazione a 850°C per 90 minuti.

Norme di riferimento

EN 60670-22 Involucri per apparecchi per installazioni elettriche fisse per usi domestici e similari. **Parte 22** Prescrizioni particolari per scatole e involucri di derivazione.

Prodotti disponibili

Cassette in alluminio verniciato

La famiglia di cassette in alluminio verniciato ha superato la prova in forno a 400°C per 300' (rapporto di prova INTEC n. RP 07-0017) e la prova prevista per i cavi a 850°C per 120' in conformità alla norma CEI EN 50362 I[^] ed.2003 rapporto di prova IMQ n. 015J00145/1-2-3.

Cassette in lamiera di acciaio

La famiglia di cassette in lamiera di acciaio, opportunamente trattata e verniciata, garantisce una resistenza alla corrosione a 720 h in nebbia salina e ha superato la prova in forno a 920°C per 20' in conformità alla norma NF C32-070 rapporto di prova CSI n.DC02/011/F05.

Cassette in acciaio INOX AISI 304

Realizzate per la massima resistenza alla corrosione, hanno superato la prova in forno a 920°C per 20' in conformità alla norma NF C32-070 rapporto di prova CSI n.DC02/011/F05.

DKC offre ai propri clienti la possibilità di personalizzare le cassette secondo le esigenze installative richieste.

In the context of the electrical installations for tunnels, the requirement for safety and reliability of the materials is fundamental. For these reasons DKC proposes a series of metallic junction boxes tested at certified institutes to demonstrate the suitability of the components to ensure electrical continuity in the event of fire.

FIRE-PROOF approved

FIRE PROOF approval ensures the successful outcome of functional tests provided for by ANAS guidelines on lighting, safety and fume extraction system. The test required by ANAS, known as FIRE PROOF (November 2009), consists of bringing the environment surrounding the junction box at 850°C for 90 minutes.

References standards

EN 60670-22 Boxes and enclosures for electrical accessories for household and similar fixed electrical installations. **Part 22** Particular requirements for connecting boxes and enclosures.

Products available

Boxes in painted aluminium

The family of boxes in painted aluminium has passed the test in an oven at 400°C for 300' (test report INTEC n. RP 07-0017) and the test required for the cables at 850°C for 120' in compliance with IEC EN 50362 I[^] Ed.2003 (test report IMQ n. 015J00145/1-2-3).

Steel sheet boxes

The family of steel sheet boxes, suitably treated and painted, ensures a corrosion resistance of 720 h in saline mist and has passed the test in the oven at 920°C for 20' in accordance with the NF C32-070 standard test report CSI n.DC02/011/F05.

Stainless steel INOX AISI 304 boxes

Made for maximum corrosion resistance, have passed the test in the oven at 920°C for 20' in accordance with the NF C32-070 standard test report CSI n.DC02/011/F05.

DKC offers its customers the possibility to customize the boxes in accordance with the requested installation requirements.



■ Scatole per tunnel Boxes for tunnels

Con linea passante a perforazione d'isolante PA360 With insulation piercing passing line PA360



Materiale

- Alluminio verniciato grigio RAL 7037
- Tensione di isolamento **400V~**
- Grado di isolamento **Classe 1 - Classe 2**
- Grado di protezione **IP66**
- Temperatura di impiego secondo norma di riferimento **-25°C +60°C**
- Massima temperatura di funzionamento (breve periodo) **-40°C +90°C**
- Resistenza agli urti CEI EN 62262 **IK10**
- Protezione tramite fusibile **4A D01 gG**
- Rapporto di prova **IMQ n. 015L000069/2** (850° per 120" CEI EN 50362)

Material

- Aluminium painted grey RAL 7037
- Insulation voltage **400V~**
- Insulation degree **Class 1 - Class 2**
- Protection degree **IP66**
- Operating temperature according to reference standard **-25°C +60°C**
- Maximum operating temperature (short period) **-40°C +90°C**
- Shock resistance IEC EN 62262 **IK10**
- Protection via fuse **4A D01 gG**
- Test report **IMQ n. 015L000069/2** (850° for 120" IEC EN 50362)

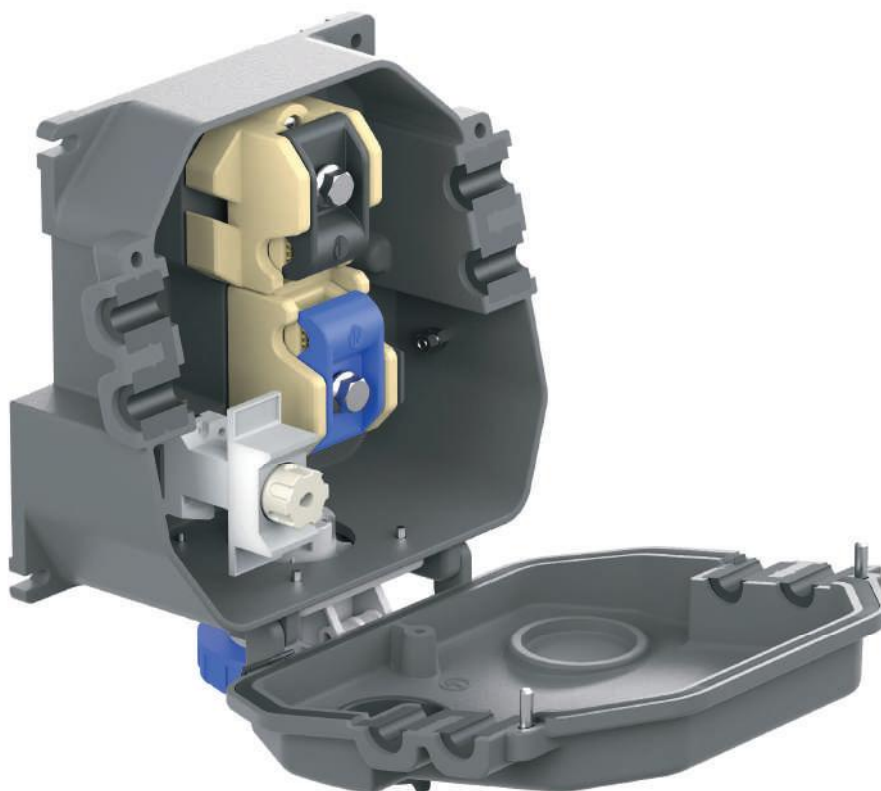
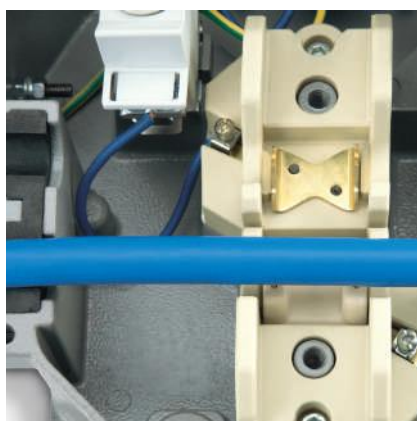
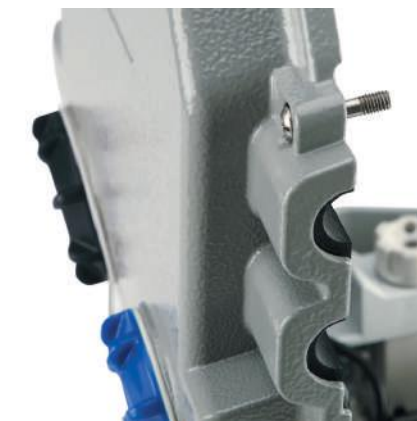

■ Scatole per tunnel Boxes for tunnels

Con linea passante a perforazione d'isolante **PA360** With insulation piercing passing line **PA360**



Con pressacavo With cable gland

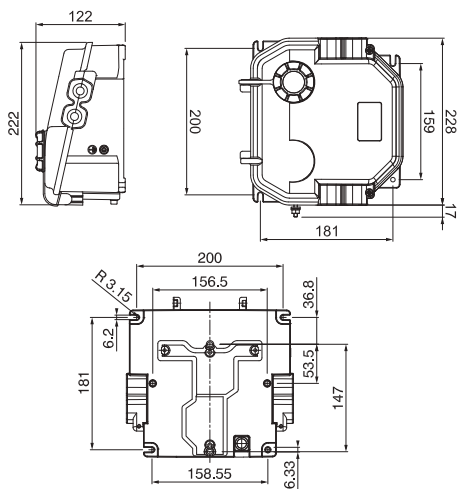

CLASSE 1 CODICE CLASS 1 CODE	CLASSE 2 CODICE CLASS 2 CODE	SEZIONE CAVI CABLES SECTION mm	PROTEZIONI PROTECTION	PRESSACAVO CABLE GLAND
PA360B	PA360BC2	4-35	1 fusibile 4A (L) 1 fuse 4A (L)	n°1 M25 (11-16mm)
PA360B2F	PA360B2FC2	4-35	2 fusibili 4A (L+N) 2 fuses 4A (L+N)	n°1 M25 (11-16mm)
PA3602B	PA3602BC2	4-35	1 fusibile 4A (L) 1 fuse 4A (L)	n°2 M25 (11-16mm)
PA3602B2F	PA3602B2FC2	4-35	2 fusibili 4A (L+N) 2 fuses 4A (L+N)	n°2 M25 (11-16mm)

Con presa CEE With CEE socket

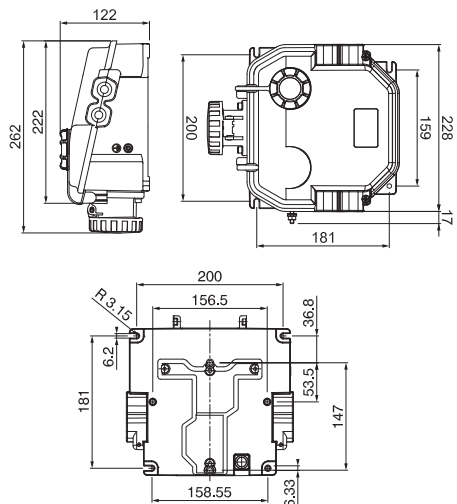

CLASSE 1 CODICE CLASS 1 CODE	CLASSE 2 CODICE CLASS 2 CODE	SEZIONE CAVI CABLES SECTION mm	PROTEZIONI PROTECTION	PRESA
PA360A	PA360AC2	4-35	1 fusibile 4A (L) 1 fuse 4A (L)	2P+T 230V IEC
PA360A2F	PA360A2FC2	4-35	2 fusibili 4A (L+N) 2 fuses 4A (L+N)	2P+T 230V IEC

■ Scatole per tunnel- Accessori Boxes for tunnels- Accessories

Staffe universali di fissaggio Universal fixing brackets

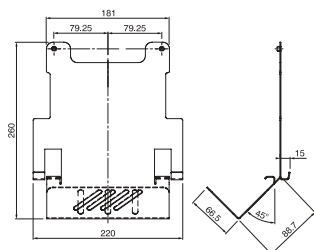
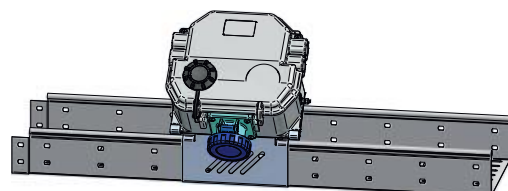
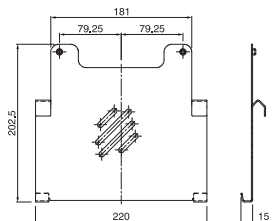
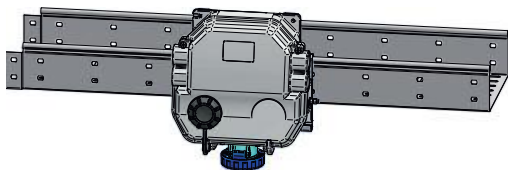

Perni di fissaggio Fixing pins

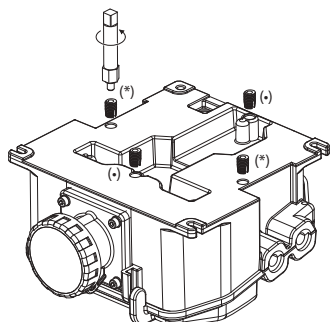

Piastra di fissaggio verticale Vertical fixing plate

CODICE CODE	DESCRIZIONE DESCRIPTION	CONFEZIONE PACKAGE
PA360PS	Acciaio verniciato RAL 7035 Painted steel RAL 7035	1
PA360PSS	Acciaio Inox AISI 304 Stainless steel AISI 304	1

Piastra di fissaggio inclinata 45° Fixing plate inclined 45°

CODICE CODE	DESCRIZIONE DESCRIPTION	CONFEZIONE PACKAGE
PA360PS45	Acciaio verniciato RAL 7035 Painted steel RAL 7035	1
PA360PSS45	Acciaio Inox AISI 304 Painted steel RAL 7035	1

CODICE CODE	DESCRIZIONE DESCRIPTION	CONFEZIONE PACKAGE
PA360KIF	Perno di fissaggio in acciaio Steel fixing pin	1
PA360KAIF	Attrezzo fissaggio perni Pins fixing tool	1

Montaggio

(*) : Inserti per fissaggio in orizzontale su staffa

(•) : Inserti per fissaggio in verticale su staffa

Montaggio manuale o con trapano a colonna degli inserti in acciaio M6

Fixing

(*) : Inserts for horizontal mounting on the bracket

(•) : Inserts for vertical mounting on the bracket

Manual or column drill fixing with a of M6 steel inserts

Scatole per tunnel

Boxes for tunnels

In lega di alluminio - cavi unipolari

Aluminium alloy - single pole cables

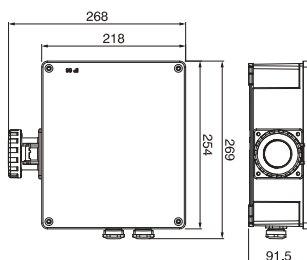
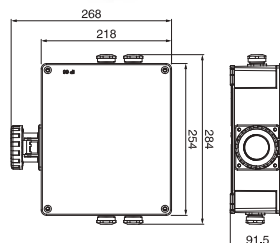
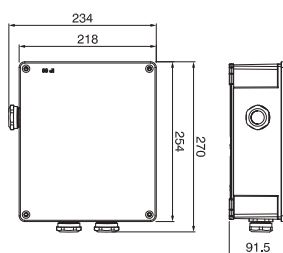
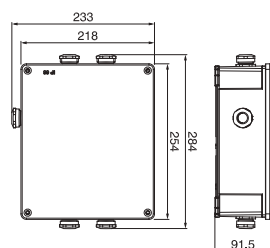

Materiale

- Alluminio verniciato grigio RAL 7037

- Protezione tramite fusibile 4A D01 gG.
- Resistenza agli urti CEI EN 62262 **IK07**

Codice di riferimento
T6530

Material

- Aluminium painted grey RAL 7037

- Protection via fuse 4A D01 gG.
- Shock resistance IEC EN 62262 **IK07**

Reference code
T6530

Scatola con pressacavo

Box with cable gland

Con Cavi Unipolari With Single Pole Cables

CODICE PRESSACAVO N.1 M25 (11-16MM) N.1 M25 (11-16MM) CABLE GLAND CODE	SEZIONE CAVI CABLES SECTION mm ²	MORSETTIERA TERMINAL BOX mm ²	PRESSACAVI IN LINEA CABLE GLAND ON LINE
4HTB4S2C1Y1	2x(1x4) 2x(1x6)	2x16	n°4 M20 (8÷12mm)
4HTB4S4C1Y1	2x(1x10)	4x16	n°4 M20 (8÷12mm)
4HTC4S4C1Y1	2x(1x16)	4x16	n°4 M25 (11÷16mm)
4HTC4Y1C1Y1	2x(1x25) 2x(1x35)	4x50	n°4 M25 (11÷16mm)

Con Fondo linea Unipolari With Base Line Single Pole

CODICE PRESSACAVO N.1 M25 (11-16MM) N.1 M25 (11-16MM) CABLE GLAND CODE	SEZIONE CAVI CABLES SECTION mm ²	MORSETTIERA TERMINAL BOX mm ²	PRESSACAVI IN LINEA CABLE GLAND ON LINE
4HTB2S2C1Y1	2x(1x4) 2x(1x6) 2x(1x10)	2x16	n°2 M20 (8÷12mm)
4HTC2S2C1Y1	2x(1x16)	2x16	n°2 M25 (11÷16mm)
4HTC2Y1C1Y1	2x(1x25) 2x(1x35)	2x50	n°2 M25 (11÷16mm)

Scatola con presa CEE

Box with CEE socket

Con Cavi Unipolari With Single Pole Cables

CODICE PRESA CEE N.1 16A - 2P+T CODE CEE SOCKETS N.1 16A - 2P+T	SEZIONE CAVI CABLES SECTION mm ²	MORSETTIERA TERMINAL BOX mm ²	PRESSACAVI IN LINEA CABLE GLAND ON LINE
4HTB4S2Z1Y1	2x(1x4) 2x(1x6)	2x16	n°4 M20 (8÷12mm)
4HTB4S4Z1Y1	2x(1x10)	4x16	n°4 M20 (8÷12mm)
4HTC4S4Z1Y1	2x(1x16)	4x16	n°4 M25 (11÷16mm)
4HTC4Y1Z1Y1	2x(1x25) 2x(1x35)	4x50	n°4 M25 (11÷16mm)

Con Fondo linea Unipolari With Base Line Single Pole

CODICE PRESA CEE N.1 16A - 2P+T CODE CEE SOCKETS N.1 16A - 2P+T	SEZIONE CAVI CABLES SECTION mm ²	MORSETTIERA TERMINAL BOX mm ²	PRESSACAVI IN LINEA CABLE GLAND ON LINE
4HTB2S2Z1Y1	2x(1x4) 2x(1x6) 2x(1x10)	2x16	n°2 M20 (8÷12mm)
4HTC2S2Z1Y1	2x(1x16)	2x16	n°2 M25 (11÷16mm)
4HTC2Y1Z1Y1	2x(1x25) 2x(1x35)	2x50	n°2 M25 (11÷16mm)

Scatole per tunnel

Boxes for tunnels

In lega di alluminio - cavi multipolari
Aluminium alloy - Multi core cables



- Protezione tramite fusibile 4A D01 gG.
- Resistenza agli urti CEI EN 62262 **IK07**

- Protection via fuse 4A D01 gG.
- Shock resistance IEC EN 62262 **IK07**

Codice di riferimento
T6530

Reference code
T6530

Scatola con pressacavo

Box with Cable Gland

Con Cavi Multipolari With Multi core Cables

CODICE PRESSACAVO N.1 M25 (11-16) N.1 M25 (11-16MM) CABLE GLAND CODE	SEZIONE CAVI CABLES SECTION mm ²	MORSETTIERA TERMINAL BOX mm ²	PRESSACAVI IN LINEA ON LINE CABLE GLAND
4HTD2S4C1Y1	4x4 - 4x6	4x16	n°2 M32 (15÷21mm)
4HTE2S6C1Y1	4x10 - 4x16	6x16	n°2 M40 (15÷27mm)
5HTF2Y2C1Y1	4x25 - 4x35	4x50	n°2 M50 (22÷35mm)

Con Fondo linea Multipolari With Base Line Multi core

CODICE PRESSACAVO N.1 M25 (11-16) N.1 M25 (11-16MM) CABLE GLAND CODE	SEZIONE CAVI CABLES SECTION mm ²	MORSETTIERA TERMINAL BOX mm ²	PRESSACAVI IN LINEA ON LINE CABLE GLAND
4HTD1S4C1Y1	4x4 - 4x6	4x16	n°1 M32 (15÷21mm)
4HTE1S4C1Y1	4x10 - 4x16	4x16	n°1 M40 (15÷27mm)
5HTF1Y2C1Y1	4x25 - 4x35	4x50	n°1 M50 (22÷35mm)

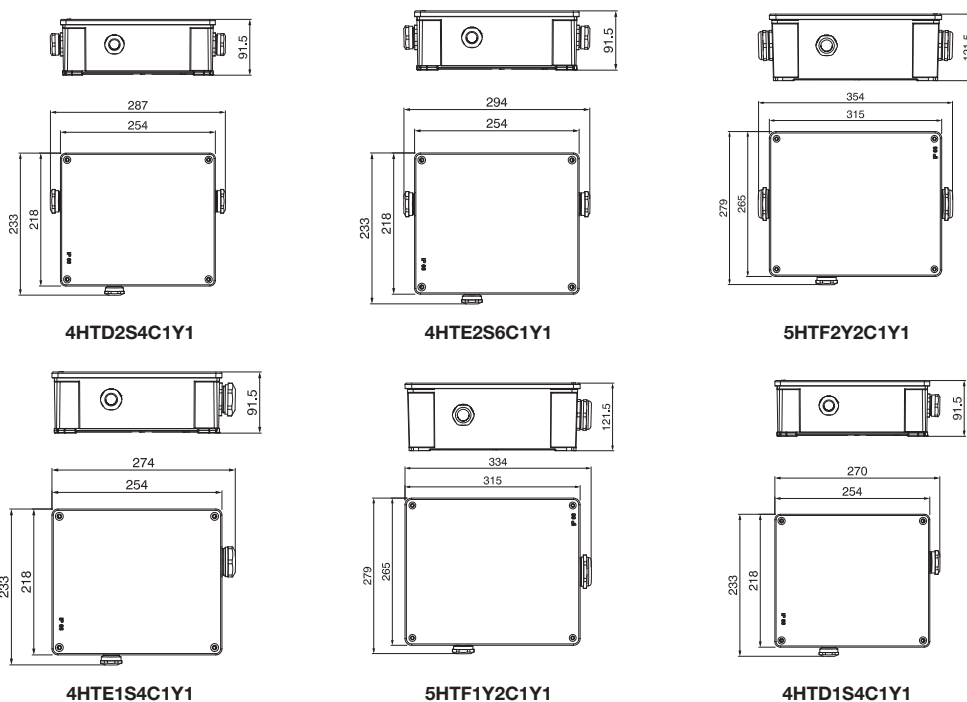

Scatole per tunnel

Boxes for tunnels

In lega di alluminio - cavi multipolari
Aluminium alloy - multi core cables



- Protezione tramite fusibile 4A D01 gG.
- Resistenza agli urti CEI EN 62262 **IK07**

- Protection via fuse 4A D01 gG.
- Shock resistance IEC EN 62262 **IK07**

Codice di riferimento
T6530

Reference code
T6530

Scatola con Presa CEE

Box with CEE

Con Cavi Multipolari With Multi core Cables

CODICE PRESA CEE N.1 16A - 2P+T CODE CEE SOCKETS N.1 16A - 2P+T	SEZIONE CAVI CABLES SECTION mm ²	MORSETTIERA TERMINAL BOX mm ²	PRESSACAVI IN LINEA ON LINE CABLE GLAND
4HTD2S4Z1Y1	4x4 - 4x6	4x16	n°2 M32 (15÷21mm)
4HTE2S6Z1Y1	4x10 - 4x16	6x16	n°2 M40 (15÷27mm)
5HTF2Y2Z1Y1	4x25 - 4x35	4x50	n°2 M50 (22÷35mm)

Con Fondo linea Multipolari With Base Line Multi core

CODICE PRESA CEE N.1 16A - 2P+T CODE CEE SOCKETS N.1 16A - 2P+T	SEZIONE CAVI CABLES SECTION mm ²	MORSETTIERA TERMINAL BOX mm ²	PRESSACAVI IN LINEA ON LINE CABLE GLAND
4HTD1S4Z1Y1	4x4 - 4x6	4x16	n°1 M32 (15÷21mm)
4HTE1S4Z1Y1	4x10 - 4x16	4x16	n°1 M40 (15÷27mm)
5HTF1Y2Z1Y1	4x25 - 4x35	4x50	n°1 M50 (22÷35mm)

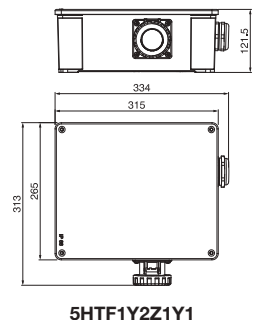
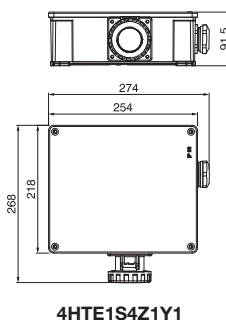
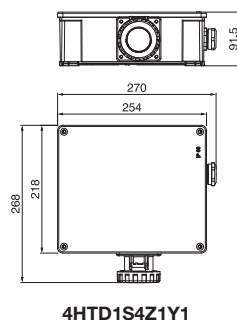
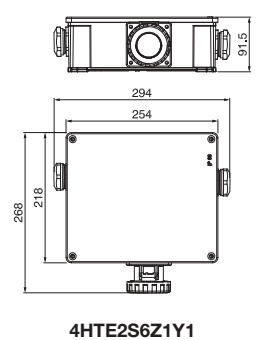
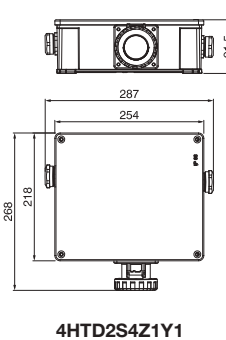
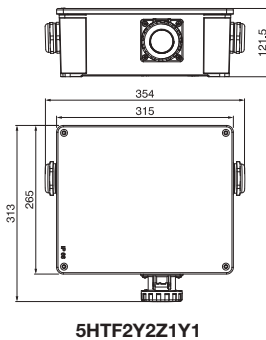

■ Scatole per tunnel Boxes for tunnels

Scatole in acciaio 640 Stainless steel box 640



Scatola in acciaio inox

Realizzate per la massima resistenza alla corrosione, hanno superato la prova in forno a 920°C per 20' in conformità alla norma NF C32-070 (rapporto di prova CSI n.DC02/011/F05).

- Protezione tramite fusibile 4A D01 gG.
- Resistenza agli urti CEI EN 62262 **IK10**

Dimensioni: 210x190x125 mm

Stainless steel box

Made for maximum corrosion resistance, they have passed the test in the oven at 920°C for 20' in accordance with the standard NF C32-070 (test report CSI n.DC02/011/F05).

- Protection via fuse 4A D01 gG.
- Shock resistance IEC EN 62262 **IK10**

Size: 210x190x125 mm



Scatola verniciata

La famiglia di cassette in alluminio verniciato ha superato la prova in forno a 400°C per 300' (rapporto di prova INTEC n. RP 07-0017) e la prova prevista per i cavi a 850°C per 90' in conformità alla norma CEI EN 50362 I[^] ed.2003 (rapporto di prova IMQ n. 015J00145/1-2-3).

- Protezione tramite fusibile 4A D01 gG.
- Resistenza agli urti CEI EN 62262 **IK10**

Dimensioni: 200x200x120 mm

Painted box

The family of boxes in painted aluminium has passed the test in an oven at 400°C for 300' (test report INTEC n. RP 07-0017) and the test required for the cables at 850°C for 120' in compliance with IEC EN 50362 I[^] Ed.2003 (test report IMQ n. 015J00145/1-2-3).

- Protection via fuse 4A D01 gG.
- Shock resistance IEC EN 62262 **IK10**

Size: 200x200x120 mm

Con cavi multipolari With multi core cables

CODICE ACCIAIO INOX STAINLESS STEEL CODE	CODICE VERNICIATA PAINTED CODE	SEZIONE CAVI CABLES SECTION mm ²	MORSETTIERA TERMINAL BOX mm ²	PRESSACAVI CABLE GLAND	
				IN LINEA ON LINE	DERIVAZIONE DERIVATION
640X-0D2S4C1Y1	640F-0D2S4C1Y1	4x4 - 4x6	4x16	n°2 M32 (15÷21mm)	n°1 M25 (11÷16mm)
640X-0E2S6C1Y1	640F-0E2S6C1Y1	4x10 - 4x16	6x16	n°2 M40 (15÷27mm)	n°1 M25 (11÷16mm)

Con cavi unipolari With single pole cables

CODICE ACCIAIO INOX STAINLESS STEEL CODE	CODICE VERNICIATA PAINTED CODE	SEZIONE CAVI CABLES SECTION mm ²	MORSETTIERA TERMINAL BOX mm ²	PRESSACAVI CABLE GLAND	
				IN LINEA ON LINE	DERIVAZIONE DERIVATION
640X-0B4S2C1Y1	640F-0B4S2C1Y1	2x(1x4) 2x(1x6)	2x16	n°4 M20 (8÷12mm)	n°1 M25 (11÷16mm)
640X-0B4S4C1Y1	640F-0B4S4C1Y1	2x(1x10)	4x16	n°4 M20 (8÷12mm)	n°1 M25 (11÷16mm)



Sistemi plastici

Plastic systems

Tubo flessibile in poliammide	Flexible conduit in polyamide	142
Tubo flessibile in poliuretano	Flexible conduit in polyurethane	159
Calza trecciata	Braided sleeving	160
Raccordi metallici per tubi flessibili in PA	Metal connectors for flexible conduit in PA	164
Raccordi ad innesto rapido in PA	Quick-couplers connectors in PA	166
Raccordi	Fittings	188
Elementi di fissaggio	Fasteners	192
Raccordi pressacavo	Gland fittings	197
Pressacavo	Cable gland	200
Ghiere	Ring nuts	202
Accessori	Accessories	203

■ Sistemi plastici Plastic systems



La realizzazione di un impianto elettrico deve essere curata in modo tale che questo non solo non sia causa d'innescò d'incendio, ma non deve costituire una via per la sua propagazione, né dare luogo a sviluppo di gas o fumi tossici.

Partendo da questo principio fondamentale a tutela della sicurezza, risulta evidente che nei locali con presenza di pubblico, devono essere utilizzati materiali privi di alogeni e a bassa emissione di fumi opachi e tossici.

I sistemi di tubi flessibili in poliammide sono prodotti da **flexa** GMBH, azienda all'avanguardia nella produzione di sistemi flessibili per la protezione cavi. Questi prodotti, certificati da prestigiosi Enti di certificazione internazionale (UL, CSA, VDE, Lloyd's Register, TUV, ecc.), trovano applicazione nei settori di automazione, macchine utensili e in generale dove sono richiesti prodotti autoestinguenti, privi di alogeni e con buona resistenza all'irraggiamento solare.

Per il settore ferroviario è disponibile una serie di prodotti specifici, realizzati in conformità alle norme CEI EN 45545-2, che dettano i requisiti di comportamento al fuoco sul materiale rotabile.

La vasta gamma di raccordi ad innesto e disinnesto rapido in poliammide, anche con filetto metallico, garantisce una tenuta stagna del sistema fino ad IP68 / IP69K. Una serie di raccordi metallici consente la realizzazione di soluzioni tecniche migliorative, in particolari condizioni di temperatura e sollecitazioni meccaniche.

The realization of an electric system must be treated in such a way that, not only does it not cause ignition of fire, but it must not constitute a way for its propagation, nor lead to the development of toxic fumes or gases.

Starting from this basic principle to ensure safety, it is clear that in places with presence of public, it is necessary to use halogen-free materials with a low emission of opaque and toxic smoke

The systems of flexible polyamide conduits are manufactured by **flexa** GMBH, a leading company in the production of flexible systems for cable protection. These products are certified by prestigious international certification institutions (UL, CSA, VDE, Lloyd's Register, TUV, etc.), and find their application in the fields of automation, machine tools and in general where are required flame retardant, halogen-free products with a good resistance to solar radiations.

For the railway sector is available a variety of specific products, manufactured in compliance with standards IEC EN 45545-2, which dictate the requirements of fire behaviour on rolling stock.

The wide range of quick polyamide coupling and disconnect fittings, also with metallic thread, ensures water tightness up to IP68 / IP69K. A series of metal fittings allows the realization of technical solutions for improvements, in particular conditions of temperature and mechanical stresses.

Campi di applicazione Application fields



Ferroviario - Segnalamento
Railway - Signalling



Bordomacchina - automazione industriale
Electrical equipment - industrial automa-
tion



Impianti in cui è richiesto un grado di protezione fino a IP69K
Installations where it is required a protec-
tion degree up to IP69K

■ Sistemi plastici Plastic systems



Vantaggi

- Grado di protezione IP68/IP69K garantita da una guarnizione già alloggiata nel raccordo
- Sbloccaggio rapido senza l'ausilio di utensili
- Tubi con apertura longitudinale per consentire l'installazione del tubo su impianti già cablati
- Treccia in acciaio per la protezione del tubo. Raccordi con bloccaggio della treccia
- Raccordi con bloccaggio conico dello schermo EMC
- Elevata flessibilità

Advantages

- Protection degree IP68/IP69K guaranteed by a gasket already housed in the connector
- Fast unlocking without use of tools
- Conduit with longitudinal opening to allow the installation of conduits on already wired systems
- Steel braid for the protection of the conduit. Connector with braid locking
- Fittings with conical locking of the EMC shield
- High flexibility

Sistemi plastici

Plastic systems

CODICE ARTICOLO CODE ARTICLE	RIF. FLEXA / MATERIALE REF. FLEXA / MATERIAL	CARATTERISTICHE CHARACTERISTICS					PROPRIETÀ PROPERTIES				FERROVIARIO RAILWAY				NAVALE NAVY	INDUSTRIA INDUSTRIAL									
		Temperatura MIN C°	Temperatura MAX C°	Temperatura DI PUNTA C° Temperatura DI PUNTA C°	PRIVO DI ALOGENI HALOGEN FREE	AUTOESTINGUENZA UL94 SELF-EXTINGUISHING UL94	Resistenza agli olii Resistance to oils	Resistenza ai solventi Resistance to solvents	Res. a flessioni alternate Res. to alternating bends	Resistenza alla fiamma Flame Resistance	CEI CENTS 45545-2:2013	DIN 5510-2	NF F 16-101/102	BS6853		UNI CEI 11170	UIC 564-2	ASTM E162/ E662 SMP800-C	Lloyds' Register	UL cURus	VDE CEI EN 61386	CSA C22.2 No. 227.3-05 / UL 1696 (DN 21,2)	EN 61373 Vibration Test	Vd TUV / GGVS	RoHS CE
5000	PA 6	-40°	+120°	+150°	■	V0	4/4	1/4	3/4	4/4	HL3	(S4/ SR2/ ST2)	(I2/F2)	■	■	■	■	■	■	■	■	■	■	■	■
5000	PA 6-D	-40°	+120°	+150°	■	V0	4/4	1/4	2/4	4/4	HL3	(S4/ SR2/ ST2)			■		■	■	■				■	■	
50HT	PA 6 HT	-25°	+150°	+170°	■	V2	4/4	3/4	3/4	4/4								■						■	
50NF	PA 6	-40°	+120°	+150°	■	V0	4/4	1/4	3/4	4/4	HL3	(S4/ SR2/ ST2)	(I2/F2)	■	■	■	■	■	■	■	■	■	■	■	■
50NF-TX	PA 6 treccia inox galv. braid	-40°	+120°	+150°	■	V0	4/4	1/4	3/4	4/4	HL3	(S4/ SR2/ ST2)	(I2/F2)	■	■	■	■	■	■	■	■	■	■	■	■
5000-T	PA 6 treccia zinc. galv. braid	-40°	+115°	+150°	■	V0	4/4	1/4	3/4	4/4	HL3	(S4/ SR2/ ST2)	(I2/F2)	■	■	■	■	■	■	■	■	■	■	■	■
5002	PA 6 S	-40°	+120°	+150°	■	HB	4/4	1/4	3/4	2/4		(S4/ SR2/ ST2)	(I4/F2)			■	■	■	■	■	■	■	■	■	■
5008	PA 6 L	-25°	+120°		■	HB	4/4	1/4	3/4	2/4							■	■	■					■	
5008-TX	PA 6 L treccia inox inox braid	-25°	+120°		■	HB	4/4	1/4	3/4	2/4							■	■	■					■	
5008 L	PA 6 LL	-25°	+120°		■	HB	4/4	1/4	1/4	2/4							■	■	■					■	
50 ZIP	PA6	-50°	+100°	+130°	■	HB	3/4	1/4	1/4	2/4														■	
50DUO	PA6	-40°	+120°	+150°	■	HB	4/4	1/4	1/4	2/4														■	
5004 MULTI	MULTI PA 6	-40°	+120°	+150°	■	HB	4/4	2/4	1/4	2/4							■		■					■	
5001 MULTI	MULTI PA 12	-50°	+100°	+130°	■	HB	4/4	2/4	2/4	3/4							■		■					■	
5001	PA 12	-50°	+100°	+130°	■	V2	4/4	2/4	4/4	3/4	HL2	(S4/ SR2/ ST2)	(I3/F2)	■	■	Classe C	■	■	■	■	■	■	■	■	■
5001-PN	PA 12-D	-50°	+100°	+130°	■	V2	4/4	2/4	4/4	3/4	HL2	(S4/ SR2/ ST2)	(I3/F2)	■	■			■	■	■	■	■	■	■	
5001-TX	PA 12-D treccia inox inox braid	-50°	+100°	+130°	■	V2	4/4	2/4	4/4	3/4	HL2	(S4/ SR2/ ST2)	(I3/F2)	■	■	■	■	■	■	■	■	■	■	■	■
5001-FN	PA 12-F	-50°	+100°	+130°	■	V2	3/4	2/4	2/4	4/4	HL3														
5006	PU	-40°	+120°	+150°	■	HB	4/4	2/4	4/4	2/4														■	
60GPA	HG-PA	-50°	+120°		■	V2	4/4	2/4	4/4	4/4		(S4/ SR2/ ST2)												■	
60GPET	HG-PET 022	-50°	+150°	+170°	■		2/4	2/4	4/4	4/4		(S4/ SR2/ ST2)												■	
60GCU 60GCUK	HG-CU HG-CUK	-50°	+250°		■		4/4	1/4	4/4	4/4														■	

Sistemi plastici

Plastic systems

CODICE ARTICOLO CODE ARTICLE	RIF. FLEXA / MATERIALE REF. FLEXA / MATERIAL	CARATTERISTICHE CHARACTERISTICS			PROPRIETÀ PROPERTIES			FERROVIARIO RAILWAY				NAVALE NAVY	INDUSTRIA INDUSTRIAL								
		Temperatura MIN C°	Temperatura MAX C°	Temperatura DI PUNTA C° Peak Temperature C°	Grado di protezione IP IP protection degree	PRIVO DI ALOGENI HALOGEN FREE	AUTOESTINGUENZA UL94 SELF-EXTINGUISHING UL94	CEI CENTS 45545-2:2013	DIN 5510-2	NF F 16-101/102	UNI CEI 11170		UIC 564-2	ASTM E162/ E662 SMP800-C	Lloyds' Register	UL cURus	VDE CEI EN 61386	CSA C22.2 No. 227.3-05 / UL 1696	Vd TUV / GGVS	RoHS CE	
5010 5011 5012 5013	RQG	-40°	+115°		IP66/ IP68	■	V0	HL2 IP68	(S1) IP68	(I3/F2) IP68	■ IP68	Classe C	■ IP68	■	■	■	■	■ IP68	■		
5012 5012-M	RQGK	-40°	+115°		IP68	■	V0	HL2	(S1)	(I3/F2)	■		■	■	■	■	■	■	■	■	
5110 5112	RQG2-3	-40°	+115°		IP66/ IP68	■	V0	HL2 IP68	(S1) IP68	(I3/F2) IP68	■ IP68		Classe C	■ IP68	■	■	■	■	■	■	
5110 5112M	RQGK2	-40°	+115°		IP68	■	V0	HL2	(S1)	(I3/F2)	■			■	■	■	■	■	■	■	■
5100	RQG2	-40°	+115°		IP68	■	V0	HL2	(S1)	(I3/F2)	■			■	■	■	■	■	■	■	■
5061 5062		-30°	+100°		IP50/ IP65	■							Classe C							■	
5029	RQB-90 RQB1-90	-40°	+115°		IP66/ IP68	■	V0	HL2 IP68	(S1) IP68	(I3/F2) IP68	■ IP68			■	■	■	■	■	■	■	■
5029	RQBK-90	-40°	+115°		IP68	■	V0	HL2	(S1)	(I3/F2)	■			■	■	■	■	■	■	■	■
5029	RQBK-90DR	-40°	+115°		IP68	■	V0	HL2	(S1)	(I3/F2)	■			■	■	■	■	■	■	■	■
5020 5021 5022 5023	RQW RQW1	-40°	+115°		IP66/ IP68	■	V0	HL2 IP68	(S1) IP68	(I3/F2) IP68	■ IP68			Classe C	■ IP68	■	■	■	■	■ IP68	■
5028	RQB45 RQB145	-40°	+115°		IP66/ IP68	■	V0	HL2 IP68	(S1) IP68	(I3/F2) IP68	■ IP68	■			■	■	■	■	■	■	■
5028	RQBK45	-40°	+115°		IP68	■	V0	HL2	(S1)	(I3/F2)	■	■			■	■	■	■	■	■	■
5027 5027 - M	RQW RQF2	-40°	+115°		IP68	■	V0					Classe C						■ RQW	■	■	
5014 5024	MULTI GFP WFP	-40°	+115°		IP54	■								■	■	■	■	■	■	■	■
5012L 5029L	RQLG1 RQLB1	-30°	+100°		IP66	■								■	■	■	■	■	■	■	■
5052	RQGI	-40°	+115°		IP66	■	V0					■	■	■	■	■	■	■	■	■	
5031	RQGR	-40°	+115°		IP68	■	V0	HL2	(S1)	(I3/F2)		■	■	■	■	■	■	■	■	■	
5050	RQE	-40°	+120°	+150°	IP65	■						■	■	■	■	■	■	■	■	■	
5097	RQA	-40°	+115°			■	V0		(S1)	(I3/F2)		■	■	■	■	■	■	■	■	■	
5033	RQT-PA	-40°	+115°		IP68	■	V0	HL2	(S1)	(I3/F2)		■	■	■	■	■	■	■	■	■	
5033	RQT-TPE	-40°	+120°	+150°	IP66	■			(S1)			■	■	■	■	■	■	■	■	■	
5025	RQY-PA	-40°	+115°		IP68	■	V0	HL2	(S1)	(I3/F2)		■	■	■	■	■	■	■	■	■	
5025	RQY-TPE	-40°	+120°	+150°	IP66	■			(S1)			■	■	■	■	■	■	■	■	■	
5030	RQK-PA	-40°	+115°		IP68	■	V0	HL2	(S1)	(I3/F2)		■	■	■	■	■	■	■	■	■	
5030	RQK-TPE	-40°	+120°	+150°	IP66	■			(S1)			■	■	■	■	■	■	■	■	■	
5012DUO 6006DUO	RQG-DUO-M GMK-DUO	-40°	+110°	+150°	IP50	■	V0					■	■	■	■	■	■	■	■	■	
5045 5045C	RQH RQHG	-40°	+115°			■	V0					■	■	■	■	■	■	■	■	■	
5043	RQS	-40°	+115°			■	V0					■	■	■	■	■	■	■	■	■	
5044		-20°	+120°			■						■	■	■	■	■	■	■	■	■	
5048	RQM	-40°	+115°			■	V0	HL2	(S1)	(I3/F2)		■	■	■	■	■	■	■	■	■	
5049	RQPRO	-40°	+115°			■						■	■	■	■	■	■	■	■	■	
5018	RQGZ	-40°	+115°		IP68	■	V2	HL2	(S1)	(I3/F2)	■	Classe C	■	■	■	■	■	■	■	■	
5018M	RQGKZ RQGKZE	-40°	+115°		IP68	■	V2	HL2	(S1)	(I3/F2)	■		■	■	■	■	■	■	■	■	■

■ Tubo flessibile in poliammide

Polyamide flexible conduit

PA 6 (V0 UL94) 5000



Tubi flessibili ondulati prodotti in poliammide (PA 6), dotati di ottima flessibilità ed elevate caratteristiche meccaniche come solidità, resistenza a compressione ed urti; requisiti ideali in tutte le applicazioni per la protezione e l'isolamento delle installazioni elettriche. Ottima resistenza alla maggior parte delle sostanze chimiche come oli (+80°C max), benzine, acidi e solventi. Autoestinguenti, con bassa tossicità e bassa densità fumogena. Privi di sostanze alogene, silicone e cadmio.

La bassa emissione di fumi in caso di incendio, li rende particolarmente indicati per applicazioni nel settore ferroviario ed in tutti i luoghi a maggior rischio di incendio. Superfici interne ed esterne ondulate consentono un ottimo scorrimento dei cavi, notevolmente più agevole rispetto ai tubi flessibili in PVC.

Buona resistenza ai raggi UV.

Flexible corrugated polyamide conduits (PA 6), designed for optimum flexibility, high compression resistance and excellent response to impact; ideal requirements in all applications for the protection and insulation of electrical installations.

Excellent resistance to most chemical substances such as oils (max. Temp. +80°C), petrol, acids and solvents. Self-extinguishing, with low toxicity and low smoke density.

Halogen, silicone and cadmium-free.

Low fume emission in case of fire makes these conduits particularly suitable for applications in the railway sector and in all places where there is a greater risk of fire. Corrugated internal and external surfaces ensure an excellent sliding of the cables, significantly easier than with flexible PVC conduits.

The product offers good resistance against UV rays.

- Standard **CEI EN 61386-1 e 61386-23, EN 60204**
- Classificazione CEI EN 61386 **2 3 2 4**
- Grado IP CEI EN 60529 **IP68 / IP69K**
- Resistenza alla compressione **320N**
- Resistenza all'urto **2 J**
- Autoestinguenza
Non propagante la fiamma CEI EN 61386 **V0 (UL94)**
- Emissioni fumi NF F 16-101 **I2 F2**

- Standard **IEC EN 61386-1 and 61386-23, EN 60204**
- Classification IEC EN 61386 **2 3 2 4**
- IP degree IEC EN 60529 **IP68 / IP69K**
- Compressive strength **320N**
- Impact resistance **2 J**
- Self-extinguishing
No flame propagation (CEI EN 61386) **V0 (UL94)**
- Fume emission NF F 16-101 **I2 F2**



Profilo fine Fine profile

CODICE NERO BLACK CODE	DIAM. NOMINALE NOMINAL DIAM. ø, mm	DIAMETRO INT. INT. DIAMETER ø d, mm	DIAMETRO EST. EXT. DIAMETER ø D, mm	RAGGIO CURVA RADIUS CURVE		Kg/mt	CONFEZIONE PACKAGE m
				Static	Din./Dyn.		
5000-07N	10,0	6,5	10,0	13	35	0,020	50
5000-10N	13,0	10,0	13,0	20	45	0,026	50
5000-12N	15,8	12,0	15,8	35	55	0,035	50
5000-14N	18,5	14,3	18,5	40	65	0,049	50
5000-17LN	21,2	16,5	21,2	45	75	0,067	50
5000-23LN	28,5	23,0	28,5	55	100	0,111	50
5000-29LN	34,5	29,0	34,5	65	120	0,136	25
5000-36LN	42,5	36,0	42,5	90	150	0,160	25
5000-48LN	54,5	48,0	54,5	100	190	0,220	25

UL 1696 CSA22.2 File n.E86359 DN 13- 54,5	
DIN 5510-2 (S4/SR2/ST2)	
EN/IEC 61386-23	
NF F 16-101/102 (I2/F2)	
ASTM E 162/ E 662	
BS 6853	
EN 45545-2	HL3

■ Tubo flessibile in poliammide Polyamide flexible conduit

PA 6-D (V0 UL94) 5000 pesante

PA 6-D (V0 UL94) 5000 heavy

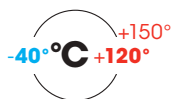

Tubi flessibili ondulati prodotti in poliammide (PA 6-D), dotati di ottima flessibilità, elevata resistenza a compressione ed ottimo comportamento agli urti; requisiti ideali in tutte le applicazioni

per la protezione e l'isolamento delle installazioni elettriche.

Ottima resistenza alla maggior parte delle sostanze chimiche come oli (+80°C max), benzine, acidi e solventi. Autoestinguenti, con bassa tossicità e bassa densità fumogena. Privi di sostanze alogene, silicone e cadmio. La bassa emissione di fumi in caso di incendio, li rende particolarmente indicati per applicazioni nel settore ferroviario ed in tutti i luoghi a maggior rischio di incendio.

Superfici interne ed esterne ondulate consentono un ottimo scorrimento dei cavi, notevolmente più agevole rispetto ai tubi flessibili in PVC.

Buona resistenza ai raggi UV.

- Standard **CEI EN 61386-1 e 61386-23, EN 60204**
- Classificazione CEI EN 61386 **2 4 2 2**
- Grado IP CEI EN 60529 **IP68 / IP69K**
- Resistenza alla compressione **320 N**
- Resistenza all'urto **6 J**
- Autoestinguenza
Non propagante la fiamma CEI EN 61386 **V0 (UL94)**

Flexible corrugated polyamide conduits (PA 6-D), designed for optimum flexibility, high compression resistance and excellent response to impact; ideal requirements in all applications for the protection and insulation of electrical installations.

Excellent resistance to most chemical substances such as oils (max. Temp. +80°C), petrol, acids and solvents.

Self-extinguishing, with low toxicity and low smoke density.

Halogen, silicone and cadmium-free.

Low fume emission in case of fire makes these conduits particularly suitable for applications in the railway sector and in all places where there is a greater risk of fire. Corrugated internal and external surfaces ensure an excellent sliding of the cables, significantly easier than with flexible PVC conduits.

The product offers good resistance against UV rays.

- Standard **IEC EN 61386-1 e 61386-23, EN 60204**
- Classification IEC EN 61386 **2 4 2 2**
- IP degree CEI EN 60529 **IP68 / IP69K**
- Compressive strength **320N**
- Impact resistance **6 J**
- Self-extinguishing
No flame propagation (CEI EN 61386) **V0 (UL94)**

UL 1696 CSA22.2
File n.E86359
DN 13- 54,5



DIN 5510-2 (S4/SR2/ST2)



EN/IEC 61386-23



EN 45545-2

HL3



Profilo fine spessorato Thickened fine profile

CODICE NERO BLACK CODE	DIAM. NOMINALE NOMINAL DIAM. ø, mm	DIAMETRO INT. INT. DIAMETER ø d, mm	DIAMETRO EST. EXT. DIAMETER ø D, mm	RAGGIO DI CURVA CURVE RADIUS		Kg/mt	CONFEZIONE PACKAGE m
				Statico	Din/Dyn.		
5000-17N	21,2	16,0	21,2	50	75	0,083	50
5000-23N	28,5	22,5	28,5	60	100	0,120	50
5000-29N	34,5	28,4	34,5	70	120	0,168	25
5000-36N	42,5	35,5	42,5	100	150	0,234	25
5000-48N	54,5	47,5	54,5	110	190	0,260	25

■ Tubo flessibile in poliammide Polyamide flexible conduit

PA 6-HT (V2 UL94) 50HT

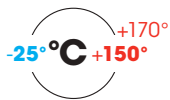

Tubi flessibili ondulati prodotti in poliammide (PA 6), dotati di ottima flessibilità, discreta resistenza a compressione ed ottimo comportamento agli urti anche ad elevate temperature. Ottima resistenza alla maggior parte delle sostanze chimiche come oli (+80°C max), benzine, acidi e solventi. Autoestinguenti, con bassa tossicità e bassa densità fumogena.

Privi di sostanze alogene, silicone e cadmio.

Superfici interne ed esterne ondulate consentono un ottimo scorrimento dei cavi, notevolmente più agevole rispetto ai tubi flessibili in PVC.

Offrono buona resistenza ai raggi UV.

- Standard **CEI EN 61386 e 61386-23**
 - Classificazione CEI EN 61386 **1 4 2 5**
 - Grado IP CEI EN 60529 **IP68 / IP69K**
 - Resistenza alla compressione **125 N**
 - Resistenza all'urto **6 J**
 - Autoestinguenza
- Non propagante la fiamma CEI EN 61386 **V2 (UL94)**

Flexible corrugated polyamide conduits (PA 6), designed for optimum flexibility, fair compression resistance and excellent response to impact also at high temperatures.

Excellent resistance to most chemical substances such as oils (max. Temp. +80°C), petrol, acids and solvents.

Self-extinguishing, with low toxicity and low smoke density.

Halogen, silicone and cadmium-free.

Corrugated internal and external surfaces ensure an excellent sliding of the cables, significantly easier than with flexible PVC conduits.

The product offers good resistance against UV rays.

- Standard **IEC EN 61386-1 and 61386-23**
 - Classification IEC EN 61386 **1 4 2 5**
 - IP degree IEC EN 60529 **IP68 / IP69K**
 - Compressive strength **125N**
 - Impact resistance **6 J**
 - Self-extinguishing
- No flame propagation IEC EN 61386 **V2 (UL94)**



Profilo fine Fine profile

CODICE NERO BLACK CODE	DIAM. NOMINALE NOMINAL DIAM. ø, mm	DIAMETRO INT. INT. DIAMETER ø d, mm	DIAMETRO EST. EXT. DIAMETER ø D, mm	RAGGIO CURVA RADIUS CURVE		Kg/mt	CONFEZIONE PACKAGE m
				Stat.	Din./Dyn.		
50HT-07N*	10	6,5	10,0	13	35	0,020	50
50HT-10N*	13	10,0	13,0	20	45	0,026	50
50HT-12N*	15,8	12,0	15,8	35	55	0,035	50
50HT-17N*	21,2	16,5	21,2	45	75	0,67	50
50HT-22N*	28,5	23,0	28,5	55	100	0,111	50
50HT-28N*	34,5	29,0	34,5	65	120	0,136	25
50HT-36N*	42,5	36,0	42,5	90	150	0,160	25
50HT-48N*	54,5	48,0	54,5	100	190	0,220	25

*A richiesta/On request

EN/IEC 61386-23



■ Tubo flessibile in poliammide

Polyamide flexible conduit

PA 6 (V0 UL94) 50NF

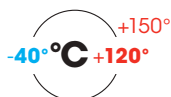

Tubi flessibili ondulati prodotti in poliammide (PA 6), dotati di ottima flessibilità ed elevate caratteristiche meccaniche come solidità, resistenza a compressione ed urti; requisiti ideali in tutte le applicazioni per la protezione e l'isolamento delle installazioni elettriche.

Ottima resistenza alla maggior parte delle sostanze chimiche come oli (+80°C max), benzine, acidi e solventi.

Autoestinguenti, con bassa tossicità e bassa densità fumogena. Privi di sostanze alogene, silicone e cadmio.

La bassa emissione di fumi in caso di incendio, li rende particolarmente indicati per applicazioni nel settore ferroviario ed in tutti i luoghi a maggior rischio di incendio. Superfici interne ed esterne ondulate consentono un ottimo scorrimento dei cavi, notevolmente più agevole rispetto ai tubi flessibili in PVC.

Flexible corrugated polyamide conduits (PA 6), designed for optimum flexibility, high compression resistance and excellent response to impact; ideal requirements in all applications for protecting and insulating electrical installations.

Excellent resistance to most chemical substances such as oils (max. Temp. +80°C), petrol, acids and solvents. Self-extinguishing, with low toxicity and low smoke density.

Halogen, silicone and cadmium-free.

Low fume emission in case of fire makes these conduits particularly suitable for applications in the railway sector and in all places where there is a greater risk of fire. Corrugated internal and external surfaces ensure an excellent sliding of the cables, significantly easier than with flexible PVC conduits.

- Standard **CEI EN 61386-1, 61386-23 ed EN 60204**
- Classificazione CEI EN 61386 **2 3 2 4**
- Grado IP CEI EN 60529 **IP68 / IP69K**
- Resistenza alla compressione **320 N**
- Resistenza all'urto **2 J**
- Autoestinguenza
Non propagante la fiamma CEI EN 61386 **V0 (UL94)**
- Emissioni fumi NF F 16-101 **I2 F2**

- Standard **IEC EN 61386-1, 61386-23 and EN 60204**
- Classificazione IEC EN 61386 **2 3 2 4**
- IP degree IEC EN 60529 **IP68 / IP69K**
- Compressive strength **320N**
- Impact resistance **2 J**
- Self-extinguishing
No flame propagation IEC EN 61386 **V0 (UL94)**
- Fume emission NF F 16-101 **I2 F2**



Profilo fine Fine profile

CODICE NERO BLACK CODE	DIAM. NOMINALE NOMINAL DIAM. ø, mm	DIAMETRO INT. INT. DIAMETER ø d, mm	DIAMETRO EST. EXT. DIAMETER ø D, mm	RAGGIO CURVA RADIUS CURVE		Kg/mt	CONFEZIONE PACKAGE m
				Stat.	Din./Dyn.		
50NF-07N	10	6,5	10,0	13	35	0,020	50
50NF-10N	13	10,0	13,0	20	45	0,026	50
50NF-12N	15,8	12,0	15,8	35	55	0,035	50



Profilo grosso Thick profile

CODICE NERO BLACK CODE	DIAM. NOMINALE NOMINAL DIAM. ø, mm	DIAMETRO INT. INT. DIAMETER ø d, mm	DIAMETRO EST. EXT. DIAMETER ø D, mm	RAGGIO CURVA RADIUS CURVE		Kg/mt	CONFEZIONE PACKAGE m
				Stat.	Din./Dyn.		
50NF-17N	21,2	15,5	21,2	45	75	0,062	50
50NF-23N	28,5	22,0	28,5	55	100	0,069	50
50NF-29N	34,5	27,5	34,5	65	120	0,114	25
50NF-36N	42,5	35,5	42,5	90	150	0,151	25
50NF-48N	54,5	47,0	54,5	110	190	0,203	25

UL 1696 CSA22.2
File n.E86359
DN 13- 54,5



DIN 5510-2 (S4/SR2/ST2)



EN/IEC 61386-23



NF F 16-101/102
(I2/F2)



ASTM E 162/ E 662

BS 6853



EN 45545-2

HL3



■ Tubo flessibile in poliammide Polyamide flexible conduit

PA 6 protetti con treccia in acciaio inox (V0 UL94) 50NF-TX

PA 6 protected by stainless steel braided sleeving (V0 UL94) 50NF-TX

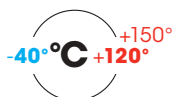

Tubi flessibili ondulati prodotti in poliammide (PA 6), dotati di ottima flessibilità, elevata resistenza a compressione ed ottimo comportamento agli urti; requisiti ideali in tutte le applicazioni per la protezione e l'isolamento delle installazioni elettriche. Sono ricoperti da una treccia in acciaio inox AISI 304 che conferisce un'elevata resistenza all'usura, urti, abrasione e scintillio.

Ottima resistenza alla maggior parte delle sostanze chimiche come oli (+80°C max), benzine, acidi e solventi. Autoestinguenti e privi di sostanze alogene, silicone e cadmio.

La bassa emissione di fumi in caso di incendio, li rende particolarmente indicati per applicazioni nel settore ferroviario ed in tutti i luoghi a maggior rischio di incendio. Superfici interne ed esterne ondulate consentono un ottimo scorrimento dei cavi, notevolmente più agevole rispetto ai tubi flessibili in PVC.

Le dimensioni si riferiscono al tubo in poliammide, indicativamente la trecciatura comporta un aumento di 1,5mm sul diametro esterno.

- Standard CEI EN 61386 e 61386 e EN 60204
- Classificazione CEI EN 61386 2 4 2 4
- Grado IP CEI EN 60529 IP68 / IP69K
- Resistenza alla compressione 320 N
- Resistenza all'urto 6 J
- Autoestinguenza
Non propagante la fiamma CEI EN 61386 V0 (UL94)
- Emissioni fumi NF F 16-101 I2 F2

Flexible corrugated polyamide conduits (PA 6 F), designed for optimum flexibility, high compression resistance and excellent response to impact; ideal requirements in all applications for the protection and insulation of electrical installations.

The conduits are protected by a AISI 304 stainless steel braided sleeving which confers a high resistance to wear, impact, abrasion and sparks.

Excellent resistance to most chemical substances such as oils (max. Temp. +80°C), petrol, acids and solvents.

Self-extinguishing and halogen, silicone and cadmium-free.

Low fume emission in case of fire makes these conduits particularly suitable for applications in the railway sector and in all places where there is a greater risk of fire. Corrugated internal and external surfaces ensure an excellent sliding of the cables, significantly easier than with flexible PVC conduits.

The dimensions refer to the polyamide conduit, indicatively the braided sleeving increases the thickness of the external diameter by 1.5mm.

- Standard IEC EN 61386-1, 61386-23 and EN 60204
- Classification IEC EN 61386 2 4 2 4
- IP degree IEC EN 60529 IP68 / IP69K
- Compressive strength 320N
- Impact resistance 6 J
- Self-extinguishing
No flame propagation IEC EN 61386 V0 (UL94)
- Fume emission NF F 16-101 I2 F2

UL 1696 CSA22.2
File n.E86359
DN 13- 54,5



DIN 5510-2 (S4/SR2/ST2)



EN/IEC 61386-23



NF F 16-101/102
(I2/F2)



ASTM E 162/ E 662

BS 6853



EN 45545-2

HL3



Profilo fine Fine profile

CODICE NERO BLACK CODE	DIAM. NOMINALE NOMINAL DIAM. ø, mm	DIAMETRO INT. INT. DIAMETER ø d, mm	DIAMETRO EST. EXT. DIAMETER ø D, mm	RAGGIO CURVA RADIUS CURVE mm (+/-10%)	Kg/mt	CONFEZIONE PACKAGE m
50NF-07TX	10	6,5	10,0	15	0,095	50
50NF-10TX	13	10,0	13,0	25	0,125	50
50NF-12TX	15,8	12,0	15,8	35	0,152	50



Profilo grosso Thick profile

CODICE NERO BLACK CODE	DIAM. NOMINALE NOMINAL DIAM. ø, mm	DIAMETRO INT. INT. DIAMETER ø d, mm	DIAMETRO EST. EXT. DIAMETER ø D, mm	RAGGIO CURVA RADIUS CURVE mm (+/-10%)	Kg/mt	CONFEZIONE PACKAGE m
50NF-17TX	21,2	15,5	21,2	50	0,232	50
50NF-23TX	28,5	22,0	28,5	60	0,312	50
50NF-29TX	34,5	27,5	34,5	70	0,368	25
50NF-36TX	42,5	35,5	42,5	100	0,456	25
50NF-48TX	54,5	47,0	54,5	110	0,552	25

Accessori correlati Related accessories

Serie Series

PAT

Raccordi metallici
Metal connector

pag. 165

■ Tubo flessibile in poliammide Polyamide flexible conduit

PA 6 protetti con treccia in acciaio zincato (V0 UL94) 5000-T

PA 6 protected by galvanized steel braided sleeving (V0 UL94) 5000-T



Tubi flessibili ricoperti da una treccia in acciaio zincato che conferisce un'elevata resistenza all'usura, urti, abrasione e scintillio. Dotati di ottima flessibilità, elevata resistenza a compressione ed ottimo comportamento agli urti; requisiti ideali in tutte le applicazioni per la protezione e l'isolamento delle installazioni elettriche. Ottima resistenza alla maggior parte delle sostanze chimiche come oli (+80°C max), benzine, acidi e solventi.

Autoestinguenti e privi di sostanze alogene, silicone e cadmio.

La bassa emissione di fumi in caso di incendio, li rende particolarmente indicati per applicazioni nel settore ferroviario ed in tutti i luoghi a maggior rischio di incendio. Superfici interne ed esterne ondulate consentono un ottimo scorrimento dei cavi, notevolmente più agevole rispetto ai tubi flessibili in PVC.

Flexible conduits covered by a galvanized steel braided sleeving that gives a high resistance to wear, shock, abrasion and sparkle. Designed for optimum flexibility, high compression resistance and excellent response to impact; ideal requirements in all applications for the protection and insulation of electrical installations. Excellent resistance to most chemical substances such as oils (max. Temp. +80°C), petrol, acids and solvents. Self-extinguishing and halogen, silicone and cadmium-free.

Low fume emission in case of fire makes these conduits particularly suitable for applications in the railway sector and in all places where there is a greater risk of fire. Corrugated internal and external surfaces ensure an excellent sliding of the cables, significantly easier than with flexible PVC conduits.



Le dimensioni si riferiscono al tubo in poliammide, indicativamente la trecciatura comporta un aumento di 1,5mm sul diametro esterno.

The dimensions refer to the polyamide conduit, indicatively the braided sleeving increases the thickness of the external diameter by 1.5mm.

- Standard CEI EN 61386-1 e 61386-23, EN 60204
- Classificazione CEI EN 61386 2 4 2 4
- Grado IP CEI EN 60529 IP68 / IP69K
- Resistenza alla compressione 320 N
- Resistenza all'urto 6 J
- Autoestinguenza
- Non propagante la fiamma CEI EN 61386 V0 (UL94)
- Emissioni fumi secondo NF F 16-101 I2 F2

- Standard IEC EN 61386-1, 61386-23 and IEC EN 60204
- Classificazione IEC EN 61386 2 4 2 4
- IP degree IEC EN 60529 IP68 / IP69K
- Compressive strength 320N
- Impact resistance 6 J
- Self-extinguishing
- No flame propagation IEC EN 61386 V0 (UL94)
- Fume emission NF F 16-101 I2 F2

UL 1696 CSA22.2 File n.E86359 DN 13- 54,5	
DIN 5510-2 (S4/SR2/ST2)	
EN/IEC 61386-23	
NF F 16-101/102 (I2/F2)	
ASTM E 162/ E 662	
BS 6853	
EN 45545-2	HL3



Profilo fine Fine profile

CODICE CODE	DIAM. NOMINALE NOMINAL DIAM. ø, mm	DIAMETRO INT. INT. DIAMETER ø d, mm	DIAMETRO EST. EXT. DIAMETER ø D, mm	RAGGIO DI CURVA RADIUS CURVE mm (+/-10%)	Kg/mt	CONFEZIONE PACKAGE m
5000-07T	10	6,5	10,0	15	0,136	50
5000-10T	13	10,0	13,0	25	0,160	50
5000-12T	15,8	12,0	15,8	35	0,187	50



Profilo grosso Thick profile

CODICE CODE	DIAM. NOMINALE NOMINAL DIAM. ø, mm	DIAMETRO INT. INT. DIAMETER ø d, mm	DIAMETRO EST. EXT. DIAMETER ø D, mm	RAGGIO DI CURVA RADIUS CURVE mm (+/-10%)	Kg/mt	CONFEZIONE PACKAGE m
5000-17T	21,2	15,5	21,2	50	0,240	50
5000-23T	28,5	22,0	28,5	60	0,376	50
5000-29T	34,5	27,5	34,5	70	0,456	25
5000-36T	42,5	35,5	42,5	100	0,520	25
5000-48T	54,5	47,0	54,5	110	0,740	25

Accessori correlati Related accessories

Serie Series
PAT

Raccordi metallici
Metal connector

pag. 165

■ Tubo flessibile in poliammide

Polyamide flexible conduit

PA 6 S (HB UL94) 5002

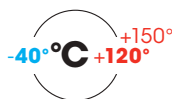

Tubi flessibili ondulati prodotti in poliammide (PA 6 S), dotati di ottima flessibilità ed elevate caratteristiche meccaniche come solidità, resistenza a compressione ed urti; requisiti ideali in tutte le applicazioni per la protezione e l'isolamento delle installazioni elettriche.

Ottima resistenza alla maggior parte delle sostanze chimiche come oli (+80°C max), benzine, acidi e solventi.

Privi di sostanze alogene, silicone e cadmio. Superfici interne ed esterne ondulate consentono un ottimo scorrimento dei cavi, notevolmente più agevole rispetto ai tubi flessibili in PVC. Offrono buona resistenza ai raggi UV.

Flexible corrugated polyamide conduits (PA 6 S), designed for optimum flexibility, high compression resistance and excellent response to impact; ideal requirements in all applications for the protection and insulation of electrical installations.

Excellent resistance to most chemical substances such as oils (max. Temp. +80°C), petrol, acids and solvents.

Halogen, silicone and cadmium-free.

Corrugated internal and external surfaces ensure an excellent sliding of the cables, significantly easier than with flexible PVC conduits.

The product offers good resistance against UV rays.

- Standard **CEI EN 61386-1 e 61386-23, EN 60204**
- Classificazione CEI EN 61386 **2 3 4 4**
- Grado IP CEI EN 60529 **IP68 / IP69K**
- Resistenza alla compressione **320 N**
- Resistenza all'urto **2 J**
- Autoestinguenza
Non propagante la fiamma CEI EN 61386 **HB (UL94)**
- Emissioni fumi NF F 16-101 **I4 F2**

- Standard **IEC EN 61386-1, 61386-23 and IEC EN 60204**
- Classification IEC EN 61386 **2 3 4 4**
- IP degree IEC EN 60529 **IP68 / IP69K**
- Compressive strength **320N**
- Impact resistance **2 J**
- Self-extinguishing
No flame propagation IEC EN 61386 **HB (UL94)**
- Fume emission NF F 16-101 **I4 F2**



Profilo fine Fine profile

UL 1696 CSA22.2 File n.E86359 DN 13- 54,5	
DIN 5510-2 (S4/SR2/ST2)	
EN/IEC 61386-23	
NF F 16-101/102 (I4/F2)	
ASTM E 162/ E 662	

CODICE NERO BLACK CODE	DIAM. NOMINALE NOMINAL DIAM. ø, mm	DIAMETRO INT. INT. DIAMETER ø d, mm	DIAMETRO EST. EXT. DIAMETER ø D, mm	RAGGIO CURVA RADIUS CURVE		Kg/mt	CONFEZIONE PACKAGE m
				stat.	din./dyn.		
5002-07N	10	6,5	10,0	13	35	0,020	50
5002-10N	13	10,0	13,0	20	45	0,030	50
5002-12N	15,8	12,0	15,8	35	55	0,038	50
5002-14N	18,5	14,3	18,2	40	65	0,052	50
5002-17N	21,2	16,5	21,2	45	75	0,063	50
5002-23N	28,5	23,0	28,5	55	100	0,103	50
5002-29N	34,5	29,0	34,5	65	120	0,142	25
5002-36N	42,5	36,0	42,5	90	150	0,159	25
5002-48N	54,5	48,0	54,5	100	190	0,220	25

■ Tubi flessibili in poliammide

Polyamide flexible conduits

PA 6 L (HB UL94) 5008



Tubi flessibili ondulati prodotti in poliammide (PA 6 modificato), dotati di elevata flessibilità e buone caratteristiche meccaniche come solidità, resistenza a compressione ed urti; requisiti ideali in tutte le applicazioni per la protezione e l'isolamento delle installazioni elettriche.

Ottima resistenza alla maggior parte delle sostanze chimiche come oli (+80°C max), benzine, acidi e solventi.

Autoestinguenti e privi di sostanze alogene, silicone e cadmio.

Superfici interne ed esterne ondulate consentono un ottimo scorrimento dei cavi, notevolmente più agevole rispetto ai tubi flessibili in PVC.

Buona resistenza ai raggi UV.

Flexible corrugated polyamide conduits (PA 6 modified), designed for optimum flexibility, and high mechanical characteristics as solidity, compression strength and impact resistance; ideal requirements in all applications for the protection and insulation of electrical installations.

Excellent resistance to most chemical substances such as oils (max. Temp. +80°C), petrol, acids and solvents.

Self-extinguishing and halogen, silicone and cadmium-free.

Corrugated internal and external surfaces ensure an excellent sliding of the cables, significantly easier than with flexible PVC conduits. The product offers good resistance against UV rays.

- Standard **CEI EN 61386-1 e 61386-23, EN 60204**
- Classificazione CEI EN 61386 **2 3 4 4**
- Grado IP CEI EN 60529 **IP68 / IP69K**
- Resistenza alla compressione **320 N**
- Resistenza all'urto **2 J**
- Autoestinguenza
Non propagante la fiamma CEI EN 61386 **HB (UL94)**
- Emissioni fumi NF F 16-101 **I4 F2**

- Standard **IEC EN 61386-1, 61386-23 and IEC EN 60204**
- Classification IEC EN 61386 **2 3 4 4**
- IP degree CEI EN 60529 **IP68 / IP69K**
- Compressive strength **320N**
- Impact resistance **2 J**
- Self-extinguishing
No flame propagation IEC EN 61386 **HB (UL94)**
- Fume emission NF F 16-101 **I4 F2**



Profilo fine Fine profile

CODICE NERO BLACK CODE	DIAM. NOMINALE NOMINAL DIAM. ø, mm	DIAMETRO INT. INT. DIAMETER ø d, mm	DIAMETRO EST. EXT. DIAMETER ø D, mm	RAGGIO CURVA RADIUS CURVE		CONFEZIONE PACKAGE m
				Stat.	Din./Dyn.	
5008-07N	10	6,5	10,0	13	35	0,020 50
5008-10N	13	10,0	13,0	20	45	0,024 50
5008-12N	15,8	12,0	15,8	35	55	0,034 50
5008-14N	18,5	14,3	18,2	40	65	0,050 50
5008-17LN	21,2	16,5	21,2	45	75	0,056 50
5008-23LN	28,5	23,0	28,5	55	100	0,100 50
5008-29LN	34,5	29,0	34,5	65	120	0,122 25
5008-36LN	42,5	36,0	42,5	90	150	0,145 25
5008-48LN	54,5	48,0	54,5	100	190	0,225 25

UL 1696 CSA22.2
File n.E86359
DN 13- 54,5



EN/IEC 61386-23



ASTM E 162/ E 662



■ Tubo flessibile in poliammide Polyamide flexible conduit

PA 6 L protetti con treccia in acciaio inox (HB UL94) 5008-TX

PA 6 L protected with braided stainless steel (HB UL94) 5008-TX



Tubi flessibili ondulati prodotti in poliammide (PA 6 modificato), dotati di elevata flessibilità e buone caratteristiche meccaniche come solidità, resistenza a compressione e urti; requisiti ideali in tutte le applicazioni per la protezione e l'isolamento delle installazioni elettriche.

Sono ricoperti da una treccia in acciaio inox che conferisce una elevata resistenza ad usura, urti, abrasione ed attacco da roditori.

Particolarmente indicati per la protezione cavi in impianti fotovoltaici a terra.

Le dimensioni si riferiscono al tubo in poliammide, indicativamente la treccia-tura comporta un aumento di 1,5mm sul diametro esterno.

**Prodotto a commessa in lotti minimi di 300m per misura.
Non disponibile a magazzino.**

Flexible corrugated polyamide conduits (PA 6 modified), designed for optimum flexibility, and high mechanical characteristics as solidity, compression strength and impact resistance; ideal requirements in all applications for the protection and insulation of electrical installations. Protected by a stainless steel braided sleeving that confers high resistance against wear, impact, abrasion and rodent damages.

Particularly suitable for cable protection in ground photovoltaic installations.

The dimensions refer to the polyamide conduit, indicatively the braided sleeving increases the thickness of the external diameter by 1.5mm.

**Produced on request in minimum lots of 300 m per measure.
Not available in stock.**



- Standard CEI EN 61386-1 e 61386-23, EN 60204
- Classificazione CEI EN 61386 2 3 4 4
- Grado IP CEI EN 60529 IP68 / IP69K
- Resistenza alla compressione 320 N
- Resistenza all'urto 2 J
- Autoestinguenza
- Non propagante la fiamma CEI EN 61386 HB (UL94)

- Standard IEC EN 61386-1, 61386-23 and EN 60204
- Classificazione IEC EN 61386 2 3 4 4
- IP degree IEC EN 60529 IP68 / IP69K
- Compressive strength 320N
- Impact resistance 2 J
- Self-extinguishing
- No flame propagation (CEI EN 61386) HB (UL94)



Profilo fine Fine profile

CODICE CODE	DIAM. NOMINALE NOMINAL DIAM.	DIAMETRO INT. INT. DIAMETER	DIAMETRO EST. EXT. DIAMETER	RAGGIO CURVA RADIUS CURVE	Kg/mt	CONFEZIONE PACKAGE
	ø, mm	ø d, mm	ø D, mm	stat.		m
5008-12TX	15,8	12,0	15,8	35	0,150	50
5008-14TX	18,5	14,3	18,5	40	0,190	50
5008-17TX	21,2	16,5	21,2	50	0,230	50
5008-23TX	28,5	23,0	28,5	60	0,345	50
5008-29TX	34,5	29,0	34,5	70	0,376	25
5008-36TX	42,5	36,0	42,5	100	0,450	25
5008-48TX	54,5	48,0	54,5	110	0,575	25

UL 1696 CSA22.2
File n.E86359
DN 13- 54,5



EN/IEC 61386-23



ASTM E 162/ E 662



Accessori correlati Related accessories

Serie Series

PAT

Raccordi metallici
Metal connector

pag. 165

■ Tubo flessibile in poliammide

Polyamide flexible conduit

PA 6 LL (HB UL94) 5008L



Tubi flessibili ondulati prodotti in poliammide (PA 6 modificato), dotati di ottima flessibilità e discrete caratteristiche meccaniche come solidità, resistenza a compressione ed urti. Ottima resistenza alla maggior parte delle sostanze chimiche come oli (+80°C max), benzine, acidi e solventi.

Autoestinguenti e privi di sostanze alogene, silicone e cadmio.

Superfici interne ed esterne ondulate consentono un ottimo scorrimento dei cavi, notevolmente più agevole rispetto ai tubi flessibili in PVC.

Offrono buona resistenza ai raggi UV.

Prodotto a commessa in lotti minimi di 300m per misura.

Non disponibile a magazzino.

- Standard **CEI EN 61386-1 e 61386-23, EN 60204**
- Classificazione CEI EN 61386 **1 1 4 4**
- Grado IP CEI EN 60529 **IP68 / IP69K**
- Resistenza alla compressione **125 N**
- Resistenza all'urto **0,5 J**
- Autoestinguenza
Non propagante la fiamma CEI EN 61386 **HB (UL94)**

Flexible corrugated polyamide conduits (PA 6 modified), designed for optimum flexibility and fair characteristics as solidity, compression and impact resistance.

Excellent resistance to most chemical substances such as oils (max. temp. +80°C), benzine, acids and solvents.

Self-extinguishing and halogen, silicone and cadmium-free.

Corrugated internal and external surfaces ensure excellent sliding through of cables, significantly easier than with flexible PVC conduits. The product offers good resistance against UV rays.

Product order in minimum lots of 300 m per measure.

Out of stock.

- Standard **IEC EN 61386-1, 61386-23 and IEC EN 60204**
- Classification IEC EN 61386 **1 1 4 4**
- IP degree IEC EN 60529 **IP68 / IP69K**
- Compressive strength **125N**
- Impact resistance **0,5 J**
- Self-extinguishing
No flame propagation (CEI EN 61386) **HB (UL94)**



Profilo fine Fine profile

CODICE CODE	DIAM. NOMINALE NOMINAL DIAM. ø, mm	DIAMETRO INT. INT. DIAMETER ø d, mm	DIAMETRO EST. EXT. DIAMETER ø D, mm	RAGGIO CURVA RADIUS CURVE stat. din./dyn.		CONFEZIONE PACKAGE m
5008L07N	10	6,5	10,0	13	35	50
5008L10N	13	10,0	13,0	20	45	50
5008L12N	15,8	12,0	15,8	35	55	50
5008L14N	18,5	14,3	18,5	40	65	50
5008L17LN	21,2	16,5	21,2	45	75	50
5008L23LN	28,5	23,0	28,5	55	100	50
5008L29LN	34,5	29,0	34,5	65	120	25



Profilo grosso Thick profile

CODICE CODE	DIAM. NOMINALE NOMINAL DIAM. ø, mm	DIAMETRO INT. INT. DIAMETER ø d, mm	DIAMETRO EST. EXT. DIAMETER ø D, mm	RAGGIO DI CURVA RADIUS CURVE stat. din./dyn.		CONFEZIONE PACKAGE m
5008L23N	28,5	22,0	28,5	55	100	25
5008L29N	34,5	27,5	34,5	65	120	25
5008L36N	42,5	35,5	42,5	90	150	25
5008L48N	54,5	47,0	54,5	100	190	25

UL 1696 CSA22.2
File n.E86359
DN 13- 54,5



EN/IEC 61386-23



■ Tubo flessibile in poliammide Polyamide flexible conduit

PA 6 con chiusura a zip (HB UL94) 50ZIP

PA 6 with zip closure (HB UL94) 50ZIP



Tubi flessibili ondulati prodotti in poliammide (PA) dotati di apertura longitudinale per consentire l'installazione del tubo su impianti già cablati ed ottenere una protezione meccanica.

La confezione comprende il tubo tagliato, una speciale guarnizione di tenuta e l'attrezzo di montaggio brevettato; quest'ultimo consente di effettuare l'infilaggio e la chiusura del tubo in un'unica semplice operazione.

Il sistema può essere impiegato anche in applicazioni dinamiche senza rischio di danneggiamento dei cavi.

Ottima resistenza alla maggior parte delle sostanze chimiche come oli (+80°C max), benzine, acidi e solventi, privi di sostanze alogene, silicone e cadmio.

Offrono buona resistenza ai raggi UV.

- Standard
CEI EN 61386-1 e 61386-23, EN 60204
- Autoestinguenza
Non propagante la fiamma CEI EN 61386
HB (UL94)
- Grado IP CEI EN 60529 IP40

Flexible corrugated polyamide conduits (PA) equipped with a longitudinal opening to allow installation of the conduit on systems already wired and obtain a mechanical protection.

The package includes the cut conduit, a special seal and the patented installation tool; the latter enables the insertion and the closure of the conduit in one simple operation.

The system can also be used in dynamic applications without risk of damaging the cables.

Excellent resistance to most chemical substances such as oils (max. Temp. +80°C), petrol, acids and solvents, halogen, silicone and cadmium-free.

The product offers good resistance against UV rays.

- Standard IEC EN 61386-1, 61386-23 and IEC EN 60204
- Self-extinguishing
No flame propagation (CEI EN 61386)
HB (UL94)
- IP degree IEC EN 60529 IP40



Profilo fine

CODICE CODE	DIAM. NOMINALE NOMINAL DIAM. ø, mm	DIAMETRO INT. INT. DIAMETER ø d, mm	DIAMETRO EST. EXT. DIAMETER ø D, mm	RAGGIO CURVA RADIUS CURVE stat.	Kg/mt	CONFEZIONE PACKAGE pz/pcs (mt)
50ZIP-10N	13	10,0	13,0	20	0,034	1 (10)
50ZIP-12N	15,8	12,0	15,8	25	0,044	1 (10)
50ZIP-17N	21,2	16,5	21,2	40	0,076	1 (10)
50ZIP-23N	28,5	23,0	28,5	45	0,110	1(10)
50ZIP-29N	34,5	29,0	34,5	55	0,153	1 (10)
50ZIP-36N	42,5	36,0	42,5	65	0,198	1 (10)
50ZIP-48N	54,5	48,5	54,5	80	0,258	1 (10)

Modalità di installazione Mode of installation



■ Tubo flessibile in poliammide Polyamide flexible conduit

PA6 DUO con apertura longitudinale (HB UL94) 50DUO

PA6 DUO with longitudinal opening (HB UL94) 50DUO



Tubi flessibili ondulati prodotti in poliammide (PA) dotati di apertura longitudinale per consentire l'installazione del tubo su impianti già cablati ed ottenere una protezione meccanica.

Il prodotto è composto da due tubi tagliati longitudinalmente aventi diametri leggermente differenti per agevolare la chiusura senza deformazione del corrugato.

Il sistema può essere impiegato anche in applicazioni dinamiche senza rischio di danneggiamento dei cavi.

Ottima resistenza alla maggior parte delle sostanze chimiche come oli (+80°C max), benzine, acidi e solventi, privi di sostanze alogene, silicone e cadmio. Offrono buona resistenza ai raggi UV.

Flexible corrugated polyamide conduits (PA) equipped with a longitudinal opening to allow installation of the conduit on systems already wired and obtain a mechanical protection.

The product is composed of two longitudinally cut conduit having slightly different diameters in order to facilitate the closure without deformation of the corrugated.

The system can also be used in dynamic applications without risk of damaging the cables.

Excellent resistance to most chemical substances such as oils (max. Temp. +80°C), petrol, acids and solvents, halogen, silicone and cadmium-free. The product offers good resistance against UV rays.

- Standard
CEI EN 61386-1, 61386-23 e
CEI EN 60204
- Grado di protezione CEI EN 60529
IP40
- Autoestinguenza
Non propagante la fiamma CEI EN 61386
HB (UL94)

- Standard
IEC EN 61386-1, 61386-23 and
IEC EN 60204
- IP protection rating EN 60529
IP40
- Self-extinguishing
No flame propagation (CEI EN 61386)
HB (UL94)

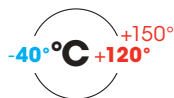

Profilo fine Fine profile

CODICE CODE	DIAM. NOMINALE NOMINAL DIAM. ø, mm	DIAMETRO INT. INT. DIAMETER ø d, mm	DIAMETRO EST. EXT. DIAMETER ø D, mm	RAGGIO CURVA RADIUS CURVE		kg/mt	CONFEZIONE PACKAGE m
				stat.	din./dyn.		
50DUO-07N	10	5,6	10,3	30	90	0,035	50
50DUO-10N	13	8,5	13,3	35	110	0,045	50
50DUO-12N	15,8	11,0	16,0	40	120	0,060	50
50DUO-17N	21,2	15,5	21,3	55	170	0,080	50
50DUO-23N	28,5	21,9	28,5	95	290	0,120	50
50DUO-29N	34,5	27,2	35,0	120	360	0,170	25
50DUO-36N	42,5	32,0	42,5	135	410	0,210	25
50DUO-48N	54,5	43,9	53,9	140	420	0,230	25
50DUO-65N	79	62,2	79,0	200	600	0,590	10

■ Tubo flessibile in poliammide Polyamide flexible conduit

MULTI-PA 6/MULTI-PA 12 (HB UL94) 5001/5004



Tubi flessibili ondulati prodotti in poliammide (PA6 - PA12) di grandi dimensioni, dotati di buona flessibilità e buone caratteristiche meccaniche come solidità, resistenza a compressione ed urti; requisiti ideali in tutte le applicazioni per la protezione e l'isolamento delle installazioni elettriche.

L'elevata resistenza ai piegamenti ripetuti, li rende particolarmente indicati per applicazioni dinamiche (cod. 5001).

Ottima resistenza alla maggior parte delle sostanze chimiche come oli, benzine, acidi e solventi. Autoestinguenti e privi di sostanze alogene, silicone e cadmio. Superfici interne ed esterne ondulate consentono un ottimo scorrimento dei cavi, notevolmente più agevole rispetto ai tubi flessibili in PVC.

Buona resistenza ai raggi UV.

Flexible corrugated polyamide conduits (PA6 - PA12) of large dimensions, designed for optimum flexibility, and good mechanical characteristics such as solidity, compression strength and impact resistance; ideal requirements in all applications for the protection and insulation of electrical installations.

The high resistance to repeated bending, makes them particularly suitable for dynamic applications (code 5001).

Excellent resistance to most chemical substances such as oils, petrol, acids and solvents. Self-extinguishing and halogen, silicone and cadmium-free.

Corrugated internal and external surfaces ensure an excellent sliding of the cables, significantly easier than with flexible PVC conduits.

The product offers good resistance against UV rays.

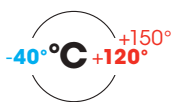

MULTI-PA 6
cod.5004

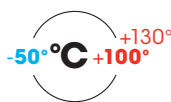

MULTI-PA 12
cod.5001



- Standard
CEI EN 61386-1 e 61386-23, EN 60204
- Grado IP CEI EN 60529
IP54 - IP65 - IP68 - IP69K
- Autoestinguenza
Non propagante la fiamma CEI EN 61386
HB (UL94)

- Standard
IEC EN 61386-1, 61386-23 and EN 60204
- IP degree IEC EN 60529
IP54 - IP65 - IP68 - IP69K
- Self-extinguishing
No flame propagation (CEI EN 61386)
HB (UL94)

MULTI-PA 6

CODICE NERO BLACK CODE	DIAM. NOMINALE NOMINAL DIAM. ø, mm	DIAMETRO INT. INT. DIAMETER ø d, mm	DIAMETRO EST. EXT. DIAMETER ø D, mm	RAGGIO DI CURVA RADIUS CURVE		CONFEZIONE PACKAGE m
				stat.	din./dyn.	
5004-70N	70	66,5	79,2	170	350	0,50
5004-100N	95	91,0	106,0	225	450	0,95

MULTI-PA 12

CODICE NERO BLACK CODE	DIAM. NOMINALE NOMINAL DIAM. ø, mm	DIAMETRO INT. INT. DIAMETER ø d, mm	DIAMETRO EST. EXT. DIAMETER ø D, mm	RAGGIO DI CURVA RADIUS CURVE		CONFEZIONE PACKAGE m
				stat.	din./dyn.	
5001-70N	70	66,5	79,2	170	350	0,46
5001-100N	95	91,0	106,0	225	450	0,85

UL 1696 CSA22.2
File n.E86359



■ Tubo flessibile in poliammide

Polyamide flexible conduit

PA 12 (V2 UL94) 5001

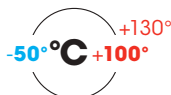

Tubi flessibili ondulati prodotti in poliammide (PA 12), dotati di ottima flessibilità ed elevate caratteristiche meccaniche come solidità, resistenza a compressione ed urti; requisiti ideali in tutte le applicazioni per la protezione e l'isolamento delle installazioni elettriche.

Grazie all'elevata resistenza ai piegamenti ripetuti, sono consigliati nelle applicazioni dinamiche.

Ottima resistenza alla maggior parte delle sostanze chimiche come oli, benzine, acidi e solventi. Autoestinguenti e privi di sostanze alogene, silicone e cadmio, presentano elevate proprietà isolanti.

La bassa emissione di fumi in caso di incendio, li rende particolarmente indicati per le applicazioni nel settore ferroviario ed in tutti i luoghi a maggior rischio di incendio.

Particolarmente idonei per applicazioni all'esterno.

Superfici interne ed esterne ondulate consentono un ottimo scorrimento dei cavi, notevolmente più agevole rispetto ai tubi flessibili in PVC.

Offrono buona resistenza ai raggi UV.

Flexible corrugated polyamide conduits (PA 12), designed for optimum flexibility, high compression resistance and excellent response to impact; ideal requirements in all applications for the protection and insulation of electrical installations.

The high resistance to repeated bending, makes them particularly suitable for dynamic applications.

Excellent resistance to most chemical substances such as oils, petrol, acids and solvents. Self-extinguishing and halogen, silicone and cadmium-free, these conduits have excellent insulating properties.

Low fume emission in case of fire makes these conduits particularly suitable for applications in the railway sector and in all places where there is a greater risk of fire.

Particularly suitable for outdoor applications.

Corrugated internal and external surfaces ensure an excellent sliding of the cables, significantly easier than with flexible PVC conduits.

The product offers good resistance against UV rays.

- Standard **CEI EN 61386-1 e 61386-23, EN 60204**
- Codice IP CEI EN 61386 **2 3 5 4**
- Classificazione secondo DIN 5510-2 **S4 / SR2 / ST2**
- Grado di protezione CEI EN 60529 **IP68 / IP69K**
- Resistenza alla compressione **320 N**
- Resistenza all'urto **2 J**
- Autoestinguenza
- Non propagante la fiamma CEI EN 61386 **V2 (UL94)**
- Emissione fumi NF F 16-101 **I3 F2 - I4 F1**

- Standard **IEC EN 61386-1, 61386-23 and EN 60204**
- IP Code IEC EN 61386 **2 3 5 4**
- Classification according to DIN 5510-2 **S4 / SR2 / ST2**
- IP degree IEC EN 60529 **IP68 / IP69K**
- Compressive strength **320 N**
- Impact resistance **2 J**
- Self-extinguishing
- No flame propagation (CEI EN 61386) **V2 (UL94)**
- Fume emission NF F 16-101 **I3 F2 - I4 F1**

UL 1696 CSA22.2
File n.E86359



DIN 5510-2 (S4/SR2/ST2)



EN/IEC 61386-23



NF F 16-101/102
(I3/F2 - I4/F1)



BS 6853



ASTM E 162/ E 662

EN 45545-2

HL2



Profilo fine Fine profile

CODICE NERO BLACK CODE	DIAM. NOMINALE NOMINAL DIAM. ø, mm	DIAMETRO INT. INT. DIAMETER ø d, mm	DIAMETRO EST. EXT. DIAMETER ø D, mm	RAGGIO CURVA RADIUS CURVE stat. din./dyn.		CONFEZIONE PACKAGE m
5001-07N	10	6,5	10,0	13	35	0,020 50
5001-10N	13	10,0	13,0	15	45	0,029 50
5001-12N	15,8	12,0	15,8	22	55	0,035 50
5001-14N	18,5	14,3	18,5	27	65	0,041 50
5001-17N	21,2	16,5	21,2	35	75	0,060 50
5001-23N	28,5	23,0	28,5	45	100	0,100 50
5001-29N	34,5	29,0	34,5	50	120	0,127 25
5001-36N	42,5	36,0	42,5	80	150	0,158 25
5001-48N	54,5	48,0	54,5	100	190	0,239 25

■ Tubo flessibile in poliammide

Polyamide flexible conduit

PA 12-D (V2 UL94) 5001 PN



Tubi flessibili ondulati prodotti in poliammide (PA 12-D), dotati di ottima flessibilità ed elevate caratteristiche meccaniche come solidità, resistenza a compressione ed urti; requisiti ideali in tutte le applicazioni per la protezione e l'isolamento delle installazioni elettriche.

Grazie all'elevata resistenza ai piegamenti ripetuti, sono consigliati nelle applicazioni dinamiche.

Ottima resistenza alla maggior parte delle sostanze chimiche come oli, benzine, acidi e solventi. Autoestinguenti e privi di sostanze alogene, silicone e cadmio, presentano elevate proprietà isolanti. La bassa emissione di fumi in caso di incendio, li rende particolarmente indicati per applicazioni nel settore ferroviario ed in tutti i luoghi a maggior rischio di incendio.

Particolarmente idonei per applicazioni all'esterno. Superfici interne ed esterne ondulate consentono un ottimo scorrimento dei cavi, notevolmente più agevole rispetto ai tubi flessibili in PVC. Offre buona resistenza ai raggi UV.

- Standard **CEI EN 61386-1 e 61386-23, EN 60204**
- Classificazione CEI EN 61386 **2 3 5 4**
- Grado IP CEI EN 60529 **IP68 / IP69K**
- Resistenza alla compressione **320 N**
- Resistenza all'urto **2 J**
- Autoestinguenza
Non propagante la fiamma CEI EN 61386 **V2 (UL94)**
- Emissioni fumi NF F 16-101 **I3 F2 - I4 F1**

Flexible corrugated polyamide conduits (PA 12-D), designed for optimum flexibility, high compression resistance and excellent response to impact; ideal requirements in all applications for the protection and insulation of electrical installations.

The high resistance to repeated bending, makes them particularly suitable for dynamic applications.

Excellent resistance to most chemical substances such as oils, petrol, acids and solvents.

Self-extinguishing and halogen, silicone and cadmium-free, these conduits have excellent insulating properties.

Low fume emission in case of fire makes these conduits particularly suitable for applications in the railway sector and in all places where there is a greater risk of fire.

Particularly suitable for outdoor applications. Corrugated internal and external surfaces ensure an excellent sliding of the cables, significantly easier than with flexible PVC conduits. Offers good resistance to UV rays.

- Standard **IEC EN 61386-1, 61386-23 and EN 60204**
- Classification IEC EN 61386 **2 3 5 4**
- IP degree IEC EN 60529 **IP68 / IP69K**
- Compressive strength **320 N**
- Impact resistance **2 J**
- Self-extinguishing
No flame propagation (CEI EN 61386) **V2 (UL94)**
- Fume emission NF F 16-101 **I3 F2 - I4 F1**



Profilo fine Fine profile

CODICE NERO BLACK CODE	DIAM. NOMINALE NOMINAL DIAM. ø, mm	DIAMETRO INT. INT. DIAMETER ø d, mm	DIAMETRO EST. EXT. DIAMETER ø D, mm	RAGGIO CURVA RADIUS CURVE		CONFEZIONE PACKAGE kg/mt m
				stat.	din./dyn.	
5001-07PN	10	6,0	10,0	15	35	0,023 50
5001-10PN	13	9,5	13,0	25	45	0,032 50
5001-12PN	15,8	11,5	15,8	35	55	0,039 50



Profilo grosso Thick profile

CODICE NERO BLACK CODE	DIAM. NOMINALE NOMINAL DIAM. ø, mm	DIAMETRO INT. INT. DIAMETER ø d, mm	DIAMETRO EST. EXT. DIAMETER ø D, mm	RAGGIO CURVA RADIUS CURVE		CONFEZIONE PACKAGE kg/mt m
				stat.o	din./dyn.	
5001-17PN	21,2	15,0	21,2	50	110	0,079 50
5001-23PN	28,5	21,5	28,5	60	120	0,120 50
5001-29PN	34,5	27,0	34,5	70	140	0,168 25
5001-36PN	42,5	35,0	42,5	80	170	0,190 25
5001-48PN	54,5	46,5	54,5	100	190	0,240 25

UL 1696 CSA22.2 File n.E86359 DN 13- 54,5	
DIN 5510-2 (S4/SR2/ST2)	
EN/IEC 61386-23	
NF F 16-101/102 (I3/F2 - I4/F1)	
ASTM E 162/ E 662	
EN 45545-2	

■ Tubo flessibile in poliammide Polyamide flexible conduit

PA 12-D protetti con treccia in acciaio inox (V2 UL94) 5001-TX

PA 12-D protected with braided stainless steel (V2 UL94) 5001-TX

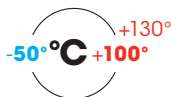

Tubi flessibili ondulati prodotti in poliammide (PA 12-D), dotati di ottima flessibilità, elevata resistenza a compressione ed ottimo comportamento agli urti ideali per la protezione e l'isolamento delle installazioni elettriche. Ottima resistenza alla maggior parte delle sostanze chimiche come oli, benzine, acidi e solventi. Autoestinguenti e privi di sostanze alogene, silicone e cadmio, presentano elevate proprietà isolanti. La bassa emissione di fumi in caso di incendio, li rende particolarmente indicati per applicazioni nel settore ferroviario ed in tutti i luoghi a maggior rischio di incendio. **Particolarmente idonei per applicazioni all'esterno.**

Superfici interne ed esterne ondulate consentono un ottimo scorrimento dei cavi, notevolmente più agevole rispetto ai tubi flessibili in PVC.

Sono ricoperti da una treccia in acciaio inox che ne conferisce una elevata resistenza all'usura, urti, abrasione, scintillio e attacco da roditori.

- Standard
IEC EN 61386-1 e 61386-23, EN 60204
- Classificazione IEC EN 61386 2 4 5 4
- Grado IP CEI EN 60529 IP68 / IP69K
- Resistenza alla compressione 320 N
- Resistenza all'urto 6 J
- Autoestinguenza
Non propagante la fiamma CEI EN 61386 V2 (UL94)
- Emissioni fumi NF F 16-101 I3 F2 - I4 F1

Flexible corrugated polyamide conduits (PA 12-D), designed for optimum flexibility, high compression strength and excellent response to impact; ideal requirements in all applications for the protection and insulation of electrical installations.

Excellent resistance to most chemical substances such as oils, petrol, acids and solvents. Self-extinguishing and halogen, silicone and cadmium-free, these conduits have excellent insulating properties.

Low fume emission in case of fire makes these conduits particularly suitable for applications in the railway sector and in all places where there is a greater risk of fire. **Particularly suitable for outdoor applications.** Corrugated internal and external surfaces ensure an excellent sliding of the cables, significantly easier than with flexible PVC conduits.

The conduits are protected by a stainless steel braided sleeving which gives them a high resistance to wear, impact, abrasion, sparks and rodent damages.

- Standard
IEC EN 61386-1, 61386-23 and EN 60204
- Classification IEC EN 61386 2 4 5 4
- IP degree IEC EN 60529 IP68 / IP69K
- Compressive strength 320 N
- Impact resistance 6 J
- Self-extinguishing
No flame propagation (CEI EN 61386 V2 (UL94))
- Fume emission NF F 16-101 I3 F2 - I4 F1



Profilo fine Fine profile

CODICE NERO BLACK CODE	DIAM. NOMINALE NOMINAL DIAM.	DIAMETRO INT. INT. DIAMETER	DIAMETRO EST. EXT. DIAMETER	RAGGIO DI CURVA RADIUS CURVE	CONFEZIONE PACKAGE	
	ø, mm	ø d, mm	ø D, mm	mm (+/-10%)	kg/mt	m
5001-07TX	10	6,0	10,0	15	0,100	50
5001-10TX	13	9,5	13,0	25	0,135	50
5001-12TX	15,8	11,5	15,8	35	0,155	50



Profilo grosso Thick profile

CODICE NERO BLACK CODE	DIAM. NOMINALE NOMINAL DIAM.	DIAMETRO INT. INT. DIAMETER	DIAMETRO EST. EXT. DIAMETER	RAGGIO DI CURVA RADIUS CURVE	CONFEZIONE PACKAGE	
	ø, mm	ø d, mm	ø D, mm	mm (+/-10%)	kg/mt	m
5001-17TX	21,2	15,0	21,2	50	0,252	50
5001-23TX	28,5	21,5	28,5	60	0,325	50
5001-29TX	34,5	27,0	34,5	70	0,390	25
5001-36TX	42,5	35,0	42,5	80	0,485	25
5001-48TX	54,5	46,5	54,5	100	0,730	25

UL 1696 CSA22.2 File n.E86359 DN 13- 54,5	
DIN 5510-2 (S4/SR2/ST2)	
EN/IEC 61386-23	
NF F 16-101/102 (I3/F2 - I4/F1)	
ASTM E 162/ E 662	
EN 45545-2:2013	

Accessori correlati Related accessories

Serie Series
PAT

Raccordi metallici
Metal connector

pag. 165

■ Tubo pieghevole in poliammide

Polyamide flexible conduit

PA 12-F (V2 UL94) 5001 FN

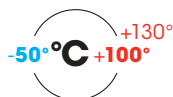

Tubi flessibili ondulati prodotti in poliammide (PA 12-F), dotati di ottima flessibilità ed elevate caratteristiche meccaniche come solidità, resistenza a compressione ed urti; Ideali per la protezione e l'isolamento delle installazioni elettriche.

Grazie all'elevata resistenza ai piegamenti ripetuti, sono consigliati nelle applicazioni dinamiche.

Ottima resistenza alla maggior parte delle sostanze chimiche come oli, benzine, acidi e solventi. Autoestinguenti e privi di sostanze alogene, silicone e cadmio, presentano elevate proprietà isolanti. La bassa emissione di fumi in caso di incendio, li rende particolarmente indicati per applicazioni nel settore ferroviario ed in tutti i luoghi a maggior rischio di incendio.

Particolarmente idonei per applicazioni all'esterno. Superfici interne ed esterne ondulate consentono un ottimo scorrimento dei cavi, notevolmente più agevole rispetto ai tubi flessibili in PVC. Offre buona resistenza ai raggi UV.

- Standard
CEI EN 61386-1 e 61386-23, EN 60204
- Classificazione CEI EN 61386 2 3 5 4
- Grado IP CEI EN 60529 **IP68 / IP69K**
- Resistenza alla compressione **320 N**
- Resistenza all'urto **2 J**
- Autoestinguenza
Non propagante la fiamma CEI EN 61386 **V2 (UL94)**

Flexible corrugated polyamide conduits (PA 12-F), designed for optimum flexibility, and high mechanical characteristics such as solidity, compression strength and impact resistance; ideal for the protection and insulation of electrical installations.

The high resistance to repeated bending, makes them particularly suitable for dynamic applications.

Excellent resistance to most chemical substances such as oils, petrol, acids and solvents. Self-extinguishing and halogen, silicone and cadmium-free, these conduits have excellent insulating properties. Low fume emission in case of fire makes these conduits particularly suitable for applications in the railway sector and in all places where there is a greater risk of fire.

Particularly suitable for outdoor applications. Corrugated internal and external surfaces ensure an excellent sliding of the cables, significantly easier than with flexible PVC conduits. Offers good resistance against UV rays.

- Standard
IEC EN 61386-1, 61386-23 and EN 60204
- Classification IEC EN 61386 2 3 5 4
- IP degree IEC EN 60529 **IP68 / IP69K**
- Compressive strength **320 N**
- Impact resistance **2 J**
- Self-extinguishing
No flame propagation (CEI EN 61386) **V2 (UL94)**



Profilo fine Fine profile

CODICE NERO BLACK CODE	DIAM. NOMINALE NOMINAL DIAM. ø, mm	DIAMETRO INT. INT. DIAMETER ø d, mm	DIAMETRO EST. EXT. DIAMETER ø D, mm	RAGGIO CURVA RADIUS CURVE		CONFEZIONE PACKAGE kg/mt m
				stat.	din./dyn.	
5001-07FN	10	6,5	10,0	13	35	0,020 50
5001-10FN	13	10,0	13,0	15	45	0,029 50
5001-12FN	15,8	12,0	15,8	22	55	0,035 50



Profilo grosso Thick profile

CODICE NERO BLACK CODE	DIAM. NOMINALE NOMINAL DIAM. ø, mm	DIAMETRO INT. INT. DIAMETER ø d, mm	DIAMETRO EST. EXT. DIAMETER ø D, mm	RAGGIO CURVA RADIUS CURVE		CONFEZIONE PACKAGE kg/mt m
				stat.	din./dyn.	
5001-17FN	21,2	15,5	21,2	45	75	0,075 50
5001-23FN	28,5	22,0	28,5	55	100	0,108 50
5001-29FN	34,5	27,5	34,5	65	120	0,132 25
5001-36FN	42,5	35,5	42,5	90	150	0,145 25
5001-48FN	54,5	47,0	54,5	100	190	0,217 25

EN/IEC 61386-23	
EN 45545-2:2013	HL3

■ Tubo pieghevole in poliuretano

Polyurethane flexible conduit

PU (HB UL94) 5006

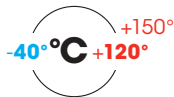

Tubi flessibili ondulati prodotti in poliuretano, dotati di eccezionale flessibilità, buone caratteristiche meccaniche anche alle basse temperature ed elevata resistenza all'abrasione; requisiti ideali in tutte le applicazioni per la protezione e l'isolamento delle installazioni elettriche.

Ottima resistenza ai microbi ed alla maggior parte delle sostanze chimiche come oli, benzine, grassi, acidi e solventi. Autoestinguenti, privi di sostanze alogene, silicone e cadmio.

Superfici interne ed esterne ondulate consentono un ottimo scorrimento dei cavi, notevolmente più agevole rispetto ai tubi flessibili in PVC.

Buona resistenza ai raggi UV.

- Standard
CEI EN 61386-1 e 61386-23, EN 60204
- Grado IP CEI EN 60529 **IP68 / IP69K**
- Classificazione IP CEI EN 61386 - - **5 4**
- Autoestinguenza
Non propagante la fiamma CEI EN 61386
HB (UL 94)

Flexible corrugated polyurethane conduits, designed for optimum flexibility, and good mechanical characteristics also at low temperatures and high abrasion resistance; ideal requirements in all applications for the protection and insulation of electrical installations.

Excellent resistance to microbes and to most chemical substances such as oils, petrol, acids and solvents.

Self-extinguishing, halogen, silicone and cadmium-free.

Corrugated internal and external surfaces ensure an excellent sliding of the cables, significantly easier than with flexible PVC conduits.

The product offers good resistance against UV rays.

- Standard
IEC EN 61386-1, 61386-23 and EN 60204
- IP degree IEC EN 60529 **IP68 / IP69K**
- Classification IEC EN 61386 - - **5 4**
- Self-extinguishing
No flame propagation (CEI EN 61386)
HB (UL94)



Profilo fine Fine profile

CODICE NERO BLACK CODE	DIAM. NOMINALE NOMINAL DIAM. ø, mm	DIAMETRO INT. INT. DIAMETER ø d, mm	DIAMETRO EST. EXT. DIAMETER ø D, mm	RAGGIO CURVA RADIUS CURVE		CONFEZIONE PACKAGE kg/mt m
				stat.	din./dyn.	
5006-07N	10	6,5	10,0	13	35	0,020 50
5006-10N	13	8,8	13,0	15	40	0,035 50
5006-12N	15,8	11,4	15,8	22	55	0,046 50



Profilo grosso Thick profile

CODICE NERO BLACK CODE	DIAM. NOMINALE NOMINAL DIAM. ø, mm	DIAMETRO INT. INT. DIAMETER ø d, mm	DIAMETRO EST. EXT. DIAMETER ø D, mm	RAGGIO CURVA RADIUS CURVE		CONFEZIONE PACKAGE kg/mt m
				stat.	din./dyn.	
5006-17N	21,2	15,2	21,2	35	75	0,056 50
5006-23N	28,5	22,0	28,5	45	100	0,090 50
5006-29N	34,5	27,5	34,5	50	120	0,120 25
5006-36N	42,5	35,5	42,5	80	150	0,165 25
5006-48N	54,5	47,0	54,5	100	190	0,225 25

■ Calze trecciate Braided sleeveings

In poliammide (V2 UL94) 60GPA Made in polyamide (V2 UL94) 60GPA



Calze trecciate realizzate con monofilo di poliammide PA6.6, offrono un'ottima resistenza all'abrasione, alle sostanze chimiche, a combustibili, liquidi e muffe. L'elevata densità di trama (copertura >85%) ed il filato robusto (0,25mm), ne consentono l'applicazione in impieghi gravosi. Autoestinguenza e nessuna tossicità in caso d'incendio le rendono particolarmente indicate nel settore ferroviario ed in tutti i luoghi a maggior rischio d'incendio. Estrema facilità di calzatura e scorrimento dei cavi; allargando le maglie è possibile fare uscire uno o più cavi in qualsiasi punto del cablaggio. L'inclinazione della trama può variare in conseguenza al diametro della treccia.

Codice di riferimento HG-PA

- Autoestinguenza CEI EN 61386
Non propagante la fiamma **V2 (UL94)**

Braided sleeving made of mono filament polyamide PA6.6, provide excellent resistance to abrasion, chemicals, fuels, liquid and mould.

The high filling density (cov. >85%) and the strong yarn (0,25mm), allow its application in heavy uses.

Self-extinguishing and no toxicity in case of fire make them particularly suitable in the railway sector and in all places with a greater risk of fire.

Extreme ease of cables sliding and fitting; expanding the mesh it is possible to release one or more cables at any point of the wiring.

The inclination of the frame may vary consequently to the diameter of the braid.

Reference code HG-PA

- Self-extinguishing CEI EN 61386
No flame propagation **V2 (UL94)**

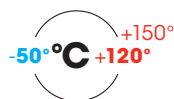

DIN 5510-2 (S4/SR2/ST2)



CODICE CODE	RANGE OPERATIVO OPERATING RANGE		kg/mt	CONFEZIONE PACKAGE m
	ø MIN d, mm	ø MAX D, mm		
60GPA-10	4	10	0,008	100
60GPA-14	7	14	0,014	100
60GPA-22	10	22	0,014	100
60GPA-27	18	27	0,017	100
60GPA-34	18	34	0,026	100
60GPA-42	28	42	0,038	50
60GPA-80	35	80	0,057	50

In polietilene 60GPET Made in polyethylene 60GPET

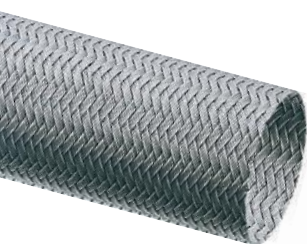

Calze trecciate realizzate con monofilo PET (polietilene), offrono una eccezionale resistenza all'abrasione, combustibili ed olii minerali. L'elevata densità di trama ed il filato robusto (0,22mm), ne consentono l'applicazione in impieghi gravosi. Estrema facilità di calzatura e scorrimento dei cavi; allargando le maglie è possibile fare uscire uno o più cavi in qualsiasi punto del cablaggio. L'inclinazione della trama può variare in conseguenza al diametro della treccia.

Colore nero e grigio RAL7037 a richiesta
Codice di riferimento HG-PET022

- Autoestinguenza CEI EN 61386
Non propagante la fiamma

Braided sleeving made of mono filament PET (polyethylene), provide excellent resistance to abrasion, fuels and mineral oils. The high filling density and the strong yarn (0.22mm), allow its application in heavy uses.

Extreme ease of cables sliding and fitting; expanding the mesh it is possible to release one or more cables at any point of the wiring.

The inclination of the frame may vary consequently to the diameter of the braid.

Colour black and grey RAL7037 on request
Reference code HG-PET022

- Self-extinguishing CEI EN 61386
No flame propagation

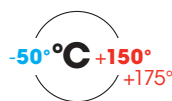

DIN 5510-2 (S4/SR2/ST2)



NF F 16-101/102
(I2/F2)



EN 45545-2:2013

HL3

CODICE NERO BLACK CODE	CODICE GRIGIO GREY CODE	RANGE OPERATIVO OPERATING RANGE		kg/mt	CONFEZIONE PACKAGE m
		ø MIN d, mm	ø MAX D, mm		
60GPET-08N	60GPET-08G*	4	8	0,006	200
60GPET-11N	60GPET-11G*	3	11	0,007	200
60GPET-14N	60GPET-14G*	6	14	0,010	150
60GPET-20N	60GPET-20G*	8	20	0,012	150
60GPET-25N	60GPET-25G*	13	25	0,013	100
60GPET-30N	60GPET-30G*	15	30	0,015	100
60GPET-38N	60GPET-38G*	28	38	0,024	100
60GPET-50N	60GPET-50G*	24	50	0,034	100
60GPET-60N	60GPET-60G*	23	60	0,042	100
60GPET-80N	60GPET-80G*	34	80	0,051	50

*A richiesta/On request

■ Calze trecciate Braided sleeveings

In acciaio zincato **60GEDU** Made in galvanized steel **60GEDU**



Calze trecciate realizzate con fili di acciaio zincato, conferiscono una elevata resistenza alla trazione, usura, abrasione e scintillio. La guaina può essere dilatata in senso assiale per facilitare il passaggio dei cavi. **Elevata densità di trama con copertura >85%.**

Codice di riferimento HG EDU

■ Standard **EN 60204**

Braided sleeving made of galvanized steel wire, confer excellent tear, wear, abrasion and flame resistance. The conduit can be stretched in the axial direction so as to facilitate the passage of the cables. **High density weft coverage >85%.**

Reference code HG EDU

■ Standard **EN 60204**

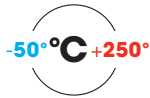

CODICE CODE	RANGE OPERATIVO		kg/mt	CONFEZIONE
	ø MIN d, mm	ø MAX D, mm		PACKAGE
60GEDU-08	5	12	0,056	m 100
60GEDU-13	8	17	0,084	50
60GEDU-17	12	22	0,098	50
60GEDU-25	16	27	0,150	50
60GEDU-40	20	35	0,160	25
60GEDU-55	25	45	0,202	25

Calze trecciate Braided sleeveings

In rame stagnato 60GCU Made in tinned copper 60GCU



Calze trecciate realizzate con fili di rame stagnato, conferiscono una elevata resistenza alla trazione, usura, abrasione e scintillio. La guaina può essere dilatata in senso assiale per facilitare il passaggio dei cavi.

Elevata densità di trama con copertura >85%.

Offrono una elevata protezione dalle interferenze elettromagnetiche su un'ampia banda di frequenze.

Codice di riferimento HG-CU

Braided sleeving made of tinned copper, confer excellent tear, wear, abrasion and flame resistance.

The conduit can be stretched in the axial direction so as to facilitate the passage of the cables.

High density weft coverage >85%.

They offer excellent protection against electromagnetic interference over a large range of frequencies.

Reference code HG-CU

- Standard **EN 60204**
- Schermatura EMC EN 50289-1-6:
0- 30MHz abbattimento fino a 80dB (60GCU -60GCUK)

- Standard **EN 60204**
- EMC shielding EN 50289-1-6:
0- 30MHz reduction up to 80dB (60GCU -60GCUK)



IEC TS 61587



CODICE CODE	RANGE OPERATIVO OPERATING RANGE		kg/mt	CONFEZIONE PACKAGE m
	ø MIN d, mm	ø MAX D, mm		
60GCU-08	5	12	0,060	100
60GCU-13	8	17	0,104	50
60GCU-17	12	22	0,098	50
60GCU-25	16	27	0,190	50
60GCU-40	20	35	0,204	25
60GCU-55	25	45	0,240	25

Calze trecciate in rame stagnato 60GCUK Braided sleeving made of tinned copper 60GCUK



Calze trecciate realizzate con fili di rame stagnato conferiscono una elevata resistenza alla trazione, usura, abrasione e scintillio.

Elevata densità di trama con copertura >85%.

Offrono una elevata protezione dalle interferenze elettromagnetiche su un'ampia banda di frequenze.

L'articolo 60GCUK è strutturato da un tubo in PVC liscio posto internamente alla treccia.

Codice di riferimento HG-CU-K

Braided sleeving made of tinned copper, confer excellent tear, wear, abrasion and flame resistance.

High density weft coverage >85%.

They offer excellent protection against electromagnetic interference over a large range of frequencies.

The article 60GCUK is structured with a smooth PVC conduit running through the braided sleeving.

Reference code HG-CU-K

- Standard **EN 60204**
- Schermatura EMC EN 50289-1-6:
0- 30MHz abbattimento fino a 80dB

- Standard **EN 60204**
- EMC shielding EN 50289-1-6:
0- 30MHz reduction up to 80dB

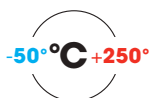

EN/IEC 61386-23



IEC TS 61587



CODICE CODE	RANGE OPERATIVO OPERATING RANGE		TUBO PVC PVC CONDUIT	kg/mt	CONFEZIONE PACKAGE m
	ø min, mm	ø max, mm	ø int., mm		
60GCUK-08	3	10	3	0,070	100
60GCUK-13	8	17	7	0,142	100
60GCUK-17	12	22	10,5	0,178	100
60GCUK-25	16	27	13	0,220	50
60GCUK-40	20	35	15	0,300	25
60GCUK-55	25	45	17	0,340	25

■ Calze trecciate - Accessori Braided sleeveings - Accessories

Adattatori per tubi in poliammide con calza interna schermante 6012EMCFP Adapters for polyamide conduits with internal tin plated copper sleeve 6012EMCFP



Realizzati in ottone nichelato, questi adattatori sono compatibili con tutta la gamma di raccordi in poliammide con filetto maschio.

Il serraggio della treccia è realizzato mediante un elemento conico che agisce sull'intera circonferenza, garantendo la continuità del sistema nelle applicazioni soggette a sollecitazioni meccaniche ed un elevato livello di sicurezza in caso di cortocircuito.

Le interferenze dei segnali elettrici generate dai campi magnetici, sono trasferite agli involucri tramite la treccia metallica e gli adattatori di bloccaggio EMC. Particolarmente indicati in applicazioni industriali, bordo macchine utensili e veicoli ferroviari (in abbinamento a tubi flessibili a bassa emissione di fumi, in conformità alla norma EN 45545).

Made in nickel plated brass, these adapters are compatible with the whole range of polyamide connectors with male thread. The tightness of the sleeve is realized by a conical element which acts along the whole circumference, ensuring the continuity of the system in applications subject to mechanical stresses as well as a high level of safety in the event of a short circuit. The interference of electrical signals generated by magnetic fields, are transferred to the casings through the metal braid and the EMC blocking adapters. Particularly recommended for industrial applications, on board machine tools and railway vehicles (used together with flexible conduits with low fume emissions, in compliance with UNI IEC 45545).

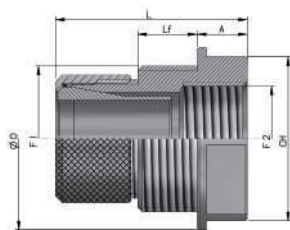

Filetto

- Metrico ISO conforme CEI EN 60423
- PG secondo DIN 40430.

Threads

- ISO metric thread IEC EN 60423
- PG in accordance with DIN 40430

■ Standard

CEI EN 61386-1, 61386-23 ed EN 60204

- Grado IP secondo CEI EN 60529

IP68/ IP69K (DIN40050 T.9) con raccordi completi di guarnizione integrata

■ Standard

IEC EN 61386-1, 61386-23 and EN 60204

- IP degree according to IEC EN 60529

IP68/ IP69K (DIN40050 T.9) with fittings complete with integrated seal

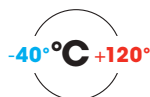

Filettatura Metrica Metrical thread

CODICE CODE	RIFERIMENTO CALZA SLEEVE REFERENCE	DIMENSIONI, mm DIMENSIONS, mm										CONFEZIONE PACKAGE
		F1 ø M	F2 ø F	PU	LF	CH	ø D	A	L	kg/100pz	Conf/pz	
6012EMCFP3225	60GCUK-25	M32x1,5	M25x1,5	17,0	13	36	39	11	42,0	5	20	100
6012EMCFP3232	60GCUK-25	M32x1,5	M32x1,5	17,0	13	41	45	24	55,0	8,5	20	100
6012EMCFP4032	60GCUK-25	M40x1,5	M32x1,5	22,5	13	46	50	13	51,0	10	10	100
6012EMCFP5040	60GCUK-55	M50x1,5	M40x1,5	32,5	14	55	59	26	58,0	16,5	10	50
6012EMCFP6363	60GCUK-55	M63x1,5	M63x1,5	43,5	14	70	75	26	57,5	15,5	5	25

Filettatura PG PG thread

CODICE CODE	RIFERIMENTO CALZA SLEEVE REFERENCE	DIMENSIONI, mm DIMENSIONS, mm										CONFEZIONE PACKAGE
		F1 ø M	F2 ø F	PU	LF	CH	ø D	A	L	kg/100pz	Conf/pz	
6010EMCFP1311	60GCUK-13	PG 13,5	PG 11	7,8	11	24	20	11	48	2,7	20	100
6010EMCFP2116	60GCUK-17	PG 21	PG 16	14	11	36	11	24	40	4,5	20	100

■ Raccordi metallici per tubi flessibili in poliammide Metal connectors for flexible conduits in polyamide

Caratteristiche Characteristics



Realizzati in ottone nichelato, la particolare conformazione del raccordo consente il bloccaggio del tubo in poliammide e della treccia metallica che lo riveste, garantendo la tenuta stagna fino ad IP68.

Una guarnizione O-Ring già alloggiata in apposita sede, garantisce il grado di protezione anche nell'accoppiamento filettato. Utilizzando i componenti dei raccordi per tubi metallici flessibili, questa soluzione offre un'ampia gamma di versioni e filettature (tipo fisso, girevole, collegamento con tubo rigido, filetto maschio o femmina) Sono proposti con filetto metrico ISO in conformità alla norma CEI EN 60423, a richiesta e per lotti minimi tutte le altre possibili soluzioni.

The connectors are made of nickel plated brass, the special structure of the connector provides the locking of the polyamide conduit and of the braided metal protective sleeving, ensuring an IP68 waterproof sealing. An O-ring already housed in the special seat ensures the degree of protection also for the threaded coupling.

Using the components of the connectors for flexible metal conduits, this solution offers a wide range of versions and threads (fixed or swivel type, connection to rigid conduit, male or female thread) Available with metric ISO thread in compliance with the standard IEC EN 60423, on request, and all other possible solutions if ordered in minimum batches.

■ Standard
CEI EN 61386-1, 61386-23 e CEI EN 60423

■ Standard
IEC EN 61386-1, 61386-23 and
IEC EN 60423

Composizione Composition

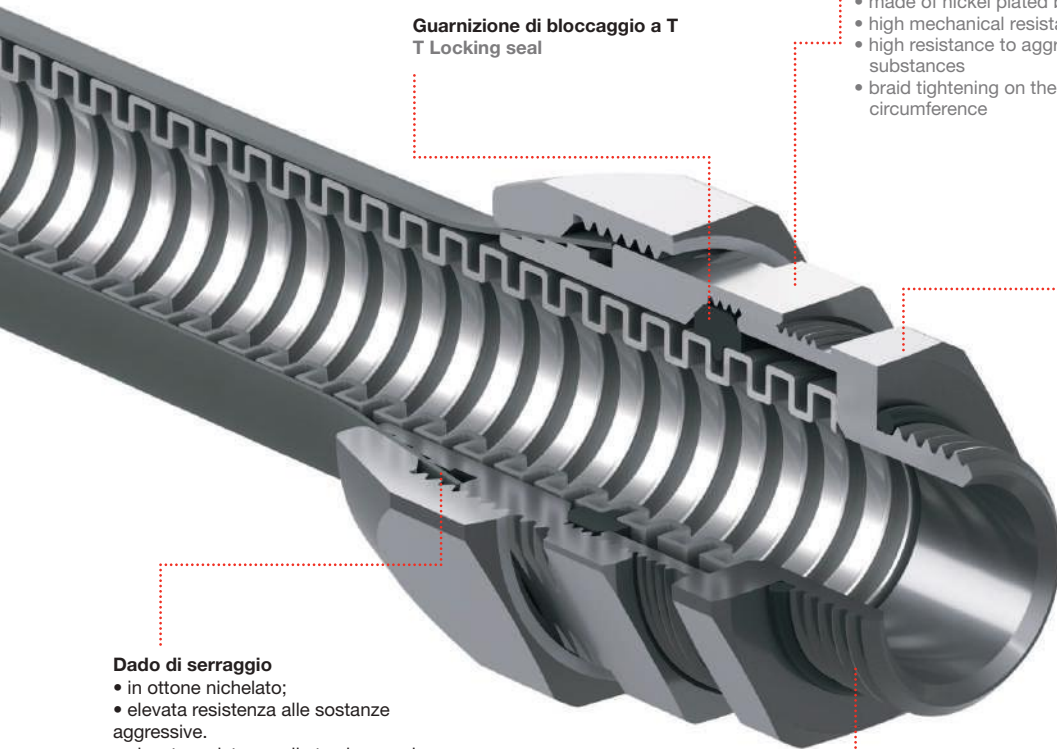

Guarnizione di bloccaggio a T
T Locking seal

Corpo intermedio

- in ottone nichelato;
- alta resistenza meccanica;
- elevata resistenza alle sostanze aggressive
- serraggio treccia sull'intera circonferenza

Intermediate body

- made of nickel plated brass;
- high mechanical resistance;
- high resistance to aggressive substances
- braid tightening on the whole circumference

Corpo del raccordo

- in ottone nichelato;
- liscio internamento per evitare il danneggiamento dei cavi;
- elevata durata e affidabilità;
- elevata resistenza alle sostanze aggressive

Connector body

- made of nickel plated brass;
- totally smooth to prevent the damage of cables;
- high durability and reliability;
- high resistance to aggressive substances

Dado di serraggio

- in ottone nichelato;
- elevata resistenza alle sostanze aggressive.
- elevata resistenza alla trazione e al carico sospeso

Tightening Nut

- made of nickel plated brass;
- high resistance to aggressive substances.
- high resistance to tensile strength and to suspended load

Filettatura

Disponibili diverse filettature
Thread

Different thread types available

■ Raccordi metallici per tubi flessibili in poliammide Metal connectors for flexible conduits in polyamide

Maschio girevole a doppio bloccaggio 6012PAT-G Double locking male swivel 6012PAT-G



IP66
IP68

-40°C +150°C

Filettatura Metrica Metric thread

CODICE CODE	DIMENSIONI, mm DIMENSIONS, mm											
	ø DN	ø F	PU	CH1	CH2	CH3	CH4	LF	L	D	kg/pz	Conf/pz
6012PAT-1216G	15,8	M16x1,5	9	22	26	22	28	10	61,0	31	0,137	10
6012PAT-1720G	21,2	M20x1,5	15	28	30	26	35	10	61,0	39	0,196	10
6012PAT-2325G	28,5	M25x1,5	20	35	40	32	42	10	64,0	47	0,295	10
6012PAT-2932G	34,5	M32x1,5	27	42	50	39	50	13	71,5	56	0,455	10
6012PAT-3640G	42,5	M40x1,5	32	55	60	50	60	14	74,0	64	0,636	5
6012PAT-4850G	54,5	M50x1,5	44	65	70	65	70	18	86,0	76	1,000	1

Maschio fisso a doppio bloccaggio 6012PAT Double locking male fixed 6012PAT



IP66
IP68

-40°C +150°C

Filettatura Metrica Metric thread

CODICE CODE	DIMENSIONI, mm DIMENSIONS, mm											
	ø DN	ø F	PU	CH1	CH2	CH4	LF	L	D	kg/pz	Conf/pz	
6012PAT-1216	15,8	M16x1,5	12	22	26	28	9	42,0	31	0,092	30	
6012PAT-1720	21,2	M20x1,5	15	28	30	35	10	61,0	39	0,161	20	
6012PAT-2325	28,5	M25x1,5	20	35	40	42	10	64,0	47	0,237	20	
6012PAT-2932	34,5	M32x1,5	27	42	50	50	13	71,5	56	0,380	10	
6012PAT-3640	42,5	M40x1,5	32	55	60	60	14	74,0	64	0,484	7	
6012PAT-4850	54,5	M50x1,5	44	65	70	70	18	86,0	76	0,770	5	

Tubo rigido - tubo flessibile a doppio bloccaggio 6117PAT Double locking metal rigid conduit - flexible conduit 6117PAT



IP66
IP68

-40°C +150°C

Filettatura Metrica Metric thread

CODICE CODE	TUBO FLESSIBILE FLEXIBLE CONDUIT	TUBO METALLICO METAL CONDUIT	DIMENSIONI DIMENSIONS							
	ø DN	ø D	PU	CH1	CH2	CH3	D	L	kg/pz	Conf/pz
6117PAT-1720	21,2	20	15,0	28	30	35	39	65,0	0,17	10
6117PAT-2325	28,5	25	21,5	35	39	42	47	68,0	0,25	10
6117PAT-2932	34,5	32	27,0	42	50	50	56	77,0	0,45	10
6117PAT-3640	42,5	40	35,0	50	55	60	64	82,5	0,60	5
6117PAT-4850	54,5	50	46,5	65	70	70	76	81,0	0,79	1

■ Raccordi ad innesto rapido in poliammide Quick-coupler connectors in polyamide

Caratteristiche Characteristics

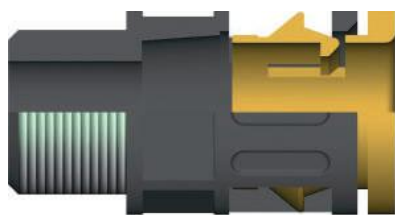

IP66
V0 (UL94)

A differenza di altri raccordi, questi hanno il vantaggio di essere costituiti da due particolari assemblati impeditibili e di poter essere utilizzati con diversi tubi flessibili, indipendentemente dal passo del profilo ondulato, purché costruiti secondo norme DIN.

Sono prodotti in poliammide 6.6 e sono costituiti da un corpo, al cui interno è alloggiato un inserto dotato di graffe di fissaggio che agiscono sul profilo ondulato del tubo flessibile.

Sono autoestinguenti e privi di sostanze alogene, silicone e cadmio. Assicurano una perfetta resistenza meccanica a compressione ed urti. Presentano alta resistenza agli oli e benzine ed in particolare ad acidi e solventi.



IP68/69K
V0 (UL94)

- Semplicità di montaggio e smontaggio in quanto non è necessario l'ausilio di utensili.
- Ottima resistenza alle vibrazioni e allo strappo.
- Dimensioni contenute che facilitano l'installazione ravvicinata.
- Bassa emissione di fumi in caso di incendio che li rende particolarmente indicati per applicazioni nel settore ferroviario e in tutti i luoghi a maggior rischio di incendio.

- Standard
CEI EN 61386-1, 61386-23 e EN 60204
- Grado IP CEI EN 60529
IP66 Raccordi privi di guarnizione
IP68/IP69K Raccordi con guarnizione integrata (verificata da VDE secondo DIN 40050 T.9)
- Emissioni fumi NF F 16-101 **I3 F2**
- Autoestinguenza
Non propagante la fiamma CEI EN 61386 **V0 (UL94)**
- EN 45545-2 **HL2**

Filettature

- Metrico ISO conforme CEI EN 60423
- GAS cilindrico UNI ISO 228
- PG secondo DIN 40430
- NPT ANSI/ ASME B1.20.1
- UNEF ANSI/ASME B1.1.

Il riferimento nominale DN presente nelle tabelle di tubi e raccordi, agevola l'individuazione dei componenti del sistema.

(Esempio: Tubo 5000-12N (DN 15,8) + Raccordo 5012-1216N (DN 15,8))

Colori
- Nero

Unlike other fittings, these have the advantage of being constituted by two unmissable parts assembled and, can be used with different flexible conduit regardless of the pitch of the corrugated profile, as long as constructed according to DIN standards.

They are produced in polyamide 6.6 and are constituted by a body, inside of which is housed an insert equipped with fixing clamps which act on the corrugated profile of the flexible conduit.

They are self-extinguishing and free of halogen substances, silicone and cadmium. Ensure perfect compression strength and resistance to impacts.

Have high resistance to oils and fuels and in particular to acids and solvents.

- Ease of assembly and disassembly as it is not necessary the use of tools.
- Excellent resistance to vibration and tearing.
- Compact size that facilitate close installation.
- Low fume emissions in case of fire makes these conduits particularly suitable for applications in the railway sector and in all places where there is a greater risk of fire.

- Standard
IEC EN 61386-1, 61386-23 and EN 60204
- IP degree IEC EN 60529
IP66 Connectors without seal
IP68/IP69K Connectors with integrated seal (VDE verified according to DIN 40050 T.9)
- Fume emission NF F 16-101 **I3 F2**
- Self-extinguishing
No flame propagation (CEI EN 61386) **V0 (UL94)**
- EN 45545-2 **HL2**

Threads

- ISO metric compliant IEC EN 60423
- UNI ISO 228 GAS cylindrical
- PG in accordance with DIN 40430
- NPT ANSI/ ASME B1.20.1
- UNEF ANSI/ASME B1.1.

The DN reference present in the tables of pipes and fittings, facilitates the identification of the components of the system.

(Example: Conduit 5000-12N (DN 15,8) + Connector 5012-1216N (DN 15,8))

Colours
- Black

■ Raccordi ad innesto rapido in poliammide Quick-coupler connectors in polyamide

Istruzioni di montaggio e smontaggio Assembly and disassembly instructions

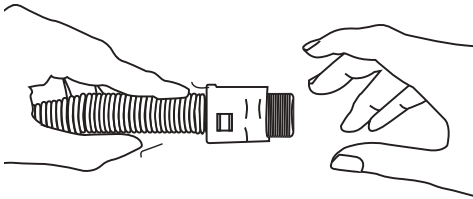

Il collegamento raccordo – tubo flessibile si ottiene semplicemente spingendo il tubo all'interno del raccordo, in quanto le graffe dell'inserto mobile, incuneandosi tra le ondulations del tubo, provocano il bloccaggio dell'accoppiamento assicurando una perfetta tenuta meccanica.

Nella versione IP66 è la forma interna del raccordo, liscia e troncoconica, a favorire la perfetta aderenza dell'accoppiamento, mentre nella versione IP68/IP69K, la tenuta è garantita da una speciale guarnizione in TPE già alloggiata nel raccordo.

Per assicurare la tenuta stagna dell'accoppiamento, è necessario eseguire un taglio ortogonale del tubo ed inserirlo energicamente nel raccordo fino alla battuta.

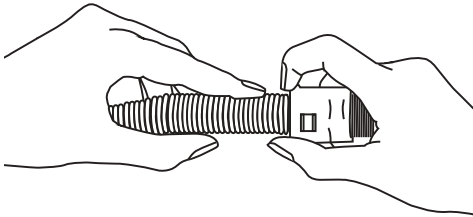

Lo sbloccaggio dell'accoppiamento si ottiene spingendo assialmente l'inserto mobile all'interno del raccordo, senza l'ausilio di utensili.

Per assecondare le esigenze di installazione, sono prodotti raccordi in svariate forme e filettature. Per applicazioni soggette a sollecitazioni è disponibile la gamma con filetto metallico.

La particolare cura nell'esecuzione di questi raccordi assicura un perfetto infilaggio dei cavi senza rischio di danneggiamento del rivestimento.

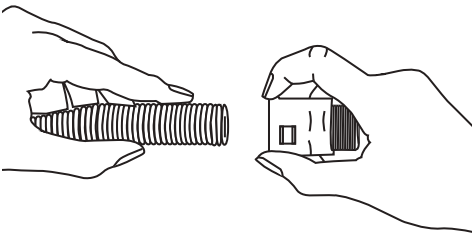

The connection, fitting a flexible conduit, is obtained by simply pushing the conduit into the fitting, as the clips of the movable insert, wedging itself between the undulations of the conduit, causes the locking of the coupling, thus ensuring a perfect mechanical seal.

In the IP66 version, the internal shape of the fitting, smooth truncated conical, facilitates the perfect adherence of the coupling, while in the IP68 / IP69K version, the tightness is ensured by a special TPE-gasket already housed in the connector

To ensure the tightness of the coupling, it is necessary to perform an orthogonal cut of the conduit and insert it firmly into the fitting until it stops.

The unlocking of the coupling is achieved by axially pushing the movable insert inside the fitting, without the aid of tools.

To meet the needs of installation, fittings are produced in various shapes and threads. For applications subject to stress a range with metallic thread is available.

The special care in the production of these connectors ensures a perfect fitting of cables without risk of damaging the coating.

Raccordi ad innesto rapido in poliammide

Quick-coupler connectors in polyamide

Diritti filetto maschio **5012 / 5011**

Straight male thread **5012 / 5011**

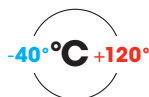
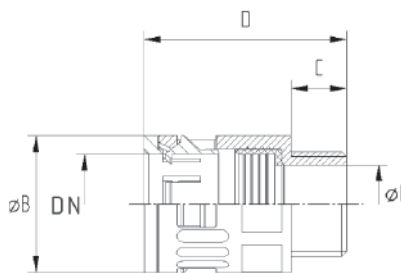

Filettature

- Metrico ISO conforme norme CEI EN 60423
- GAS cilindrico UNI ISO 228
- PG secondo DIN 40430
- NPT in conformità alle norme ANSI B2.1

Colore

Nero

Codice di riferimento

RQG1 IP66
RQG IP68/69K

Threads

- ISO metric in compliance with IEC EN 60423
- UNI ISO 228 GAS cylindrical
- PG according to DIN 40430
- NPT in compliance with ANSI B2.1

Colours

Black

Reference code

RQG1 IP66
RQG IP68/69K

Filettatura Metrica Metric thread

CODICE IP66 IP66 CODE	CODICE IP68/IP69K IP68/IP69K CODE	DIMENSIONI, mm DIMENSIONS, mm								CONFEZIONE PACKAGE	
		DN ø	ø F	ø I	ø B	C	D	CH	kg/100pz	m	
5012-0710N	5012-0710N67	10	M 10 x 1,0	6,0	17,0	11,5	34,5	16	0,40	50	
5012-0712N	5012-0712N67	10	M 12 x 1,5	7,0	17,0	11,5	34,5	16	0,40	50	
5012-1012N	5012-1012N67	13	M 12 x 1,5	7,0	20,0	12,0	37,0	18	0,52	50	
5012-1016N	5012-1016N67	13	M 16 x 1,5	10,0	20,0	11,5	37,0	18	0,54	50	
5012-1216N	5012-1216N67	15,8	M 16 x 1,5	11,0	23,0	11,5	39,0	21	0,70	50	
5012-1220N	5012-1220N67	15,8	M 20 x 1,5	12,0	25,0	13,0	39,0	21	0,76	50	
5012-1420N	5012-1420N67	18,5	M 20 x 1,5	16,0	26,0	13,0	43,0	24	0,80	50	
5012-1720N	5012-1720N67	21,2	M 20 x 1,5	16,0	29,5	13,0	44,5	27	1,12	50	
5012-1725N	5012-1725N67	21,2	M 25 x 1,5	17,0	29,5	13,0	44,5	27	1,24	50	
5012-1732N	5012-1732N67	21,2	M 32 x 1,5	17,0	37,0	15,0	48,0	27	1,50	50	
5012-2325N	5012-2325N67	28,5	M 25 x 1,5	20,5	37,0	13,0	47,0	34	1,68	25	
5012-2332N	5012-2332N67	28,5	M 32 x 1,5	23,5	37,0	15,0	49,0	34	1,80	25	
5012-2932N	5012-2932N67	34,5	M 32 x 1,5	25,5	44,0	15,0	51,0	40	2,40	25	
5012-2940N	5012-2940N67	34,5	M 40 x 1,5	30,5	48,5	15,0	51,5	40	2,56	25	
5012-3640N	5012-3640N67	42,5	M 40 x 1,5	32,0	58,0	17,0	76,0	55	5,80	25	
5012-3650N	5012-3650N67	42,5	M 50 x 1,5	37,5	63,0	17,0	76,0	60	6,72	10	
5012-4850N	5012-4850N67	54,5	M 50 x 1,5	42,5	68,0	17,0	88,0	65	8,30	10	
5012-4863N	5012-4863N67	54,5	M 63 x 1,5	49,0	74,0	17,0	88,0	70	8,50	10	

RQG1 IP66

UL 1696 CSA22.2
File n.E86359
DN 13- 54,5



EN/IEC 61386-23



RQG IP68/69K

UL 1696 CSA22.2
File n.E86359
DN 13- 54,5



DIN 5510-2 (S1)



EN/IEC 61386-23



NF F 16-101/102
(I3/F2)



EN 45545-2



Filettatura GAS GAS thread

CODICE IP66 IP66 CODE	CODICE IP68/IP69K IP68/IP69K CODE	DIMENSIONI, mm DIMENSIONS, mm								CONFEZIONE PACKAGE	
		DN ø	ø F	ø I	ø B	C	D	CH	kg/100pz	m	
5011-07014N	-	10	1/4"	7,0	17,0	10,0	32,5	16	0,40	50	
5011-10012N	5011-10012N67	13	1/2"	13,0	27,0	14,0	39,5	18	0,52	50	
5011-10014N	5011-10014N67	13	1/4"	9,0	20,0	10,0	35,0	18	0,50	50	
5011-10038N	5011-10038N67	13	3/8"	10,0	21,0	10,0	35,0	18	0,66	50	
5011-12012N	5011-12012N67	15,8	1/2"	12,5	27,0	13,5	41,5	21	0,64	50	
5011-12038N	5011-12038N67	15,8	3/8"	12,5	23,0	10,0	37,0	21	0,76	50	
5011-17012N	5011-17012N67	21,2	1/2"	16,0	29,5	13,0	45,5	27	1,14	50	
5011-23034N	5011-23034N67	28,5	3/4"	20,5	37,0	13,0	48,0	34	1,72	25	
5011-29001N	5011-29001N67	34,5	1"	25,5	44,0	16,0	52,0	40	2,28	25	
5011-36114N	5011-36114N67	42,5	1"1/4	35,0	52,0	18,0	59,0	60	3,08	25	
5011-48112N	5011-48112N67	54,5	1"1/2	40,0	64,0	14,0	89,0	70	4,40	10	
5011-48002N	5011-48002N67	54,5	2"	49,0	64,0	18,0	89,0	70	4,50	10	

Raccordi ad innesto rapido in poliammide

Quick-coupler connectors in polyamide

Diritti filetto maschio **5010 / 5013**

Straight male thread **5010 / 5013**

Filettatura PG PG thread

CODICE IP66 IP66 CODE	CODICE IP68/IP69K IP68/IP69K CODE	DN ϕ	ϕ F	ϕ I	DIMENSIONI, mm DIMENSIONS, mm				kg/100pz	CONFEZIONE PACKAGE	
					ϕ B	C	D	CH		m	
5010-0707N	5010-0707N67	10	7	7,0	17,0	10,0	32,5	16	0,40	50	
5010-0709N	5010-0709N67	10	9	7,0	18,5	10,0	32,5	16	0,42	50	
5010-0711N	5010-0711N67	10	11	7,0	21,0	10,0	32,5	16	0,48	50	
5010-0713N	5010-0713N67	10	13,5	7,0	23,0	10,0	32,5	16	0,52	25	
5010-1007N	5010-1007N67	13	7	8,0	20,0	10,0	35,0	18	0,50	50	
5010-1009N	5010-1009N67	13	9	10,0	20,0	10,0	35,0	18	0,50	50	
5010-1011N	5010-1011N67	13	11	10,0	21,0	10,0	35,0	18	0,54	50	
5010-1013N	5010-1013N67	13	13,5	10,0	23,0	10,0	35,0	18	0,60	25	
5010-1211N	5010-1211N67	15,8	11	12,5	23,0	10,0	37,0	21	0,70	50	
5010-1213N	5010-1213N67	15,8	13,5	12,5	23,0	10,0	37,0	21	0,70	25/50	
5010-1216N	5010-1216N67	15,8	16	12,5	26,5	10,0	37,0	21	0,76	25	
5010-1413N	5010-1413N67	18,5	13,5	13,5	26,0	13,0	43,0	24	0,86	50	
-	5010-1416N67	18,5	16	17,0	25,5	11,0	42,0	24	0,96	25	
5010-1713N	5010-1713N67	21,2	13,5	15,4	29,5	10,0	43,5	27	1,20	10	
5010-1716N	5010-1716N67	21,2	16	17,0	29,5	13,0	46,0	27	1,20	50	
5010-2316N	5010-2316N67	28,5	16	17,0	37,0	12,0	48,5	34	1,80	10	
5010-2321N	5010-2321N67	28,5	21	23,5	37,0	12,5	48,5	34	1,68	25	
5010-2929N	5010-2929N67	34,5	29	30,0	44,0	14,5	53,5	40	2,36	25	
5010-3636N	5010-3636N67	42,5	36	36,0	63,0	17,0	76,0	60	6,00	25	
5010-4848N	5010-4848N67	54,5	48	47,5	74,0	17,0	88,0	70	9,20	10	

Filettatura NPT NPT thread

CODICE IP68/IP69K IP68/IP69K CODE	DN ϕ	ϕ F	ϕ I	DIMENSIONI, mm DIMENSIONS, mm				kg/100pz	CONFEZIONE PACKAGE	
				ϕ B	C	D	CH		m	
5013-07014N*	10	1/4"	7	17	11,5	34	16	0,42	50	
5013-10014N*	13	1/4"	10	20	12	37	18	0,56	50	
5013-10038N*	13	3/8"	10	20	12	37	18	0,54	50	
5013-12038N*	15,8	3/8"	12,5	23	12	39	21	0,60	50	
5013-12012N*	15,8	1/2"	12,5	25	12	39	21	0,72	50	
5013-21012N*	21,2	1/2"	17	29,5	13	43,5	27	1,14	50	
5013-22034N*	28,5	3/4"	21	37	14	47,5	34	1,68	25	
5013-28001N*	34,5	1"	27,5	44	16	52	40	2,20	25	
5013-36114N*	42,5	1"1/4	36,5	52	18	77	60	1,52	25	
5013-36112N*	42,5	1"1/2	36,5	55	18	77	60	3,50	25	
5013-48112N*	54,5	1"1/2	42,5	64	18	89	70	4,40	10	
5013-48002N*	54,5	2"	48,5	64	21	92	70	4,50	10	

*A richiesta/On request

Raccordi ad innesto rapido in poliammide

Quick-coupler connectors in polyamide

Diritti filetto maschio metallico 5012M

Straight metallic male thread 5012M



La parte terminale è costituita da un inserto filettato in ottone nichelato. Indicati per applicazioni in condizioni particolari di temperatura e di sollecitazioni meccaniche. Le filettature proposte sono: Metrico ISO in conformità con le norme CEI EN 60423 e PG secondo DIN 40430.

The terminal part consists of a threaded insert in nickel-plated brass. Suitable for applications in particular temperature conditions and mechanical stresses. The threads proposed are: ISO metric in compliance with IEC EN 60423 and PG in accordance with DIN 40430.

Colore
Nero

Colours
Black

Codice di riferimento
RQGK IP68/IP69K

Reference code
RQGK IP68/IP69K

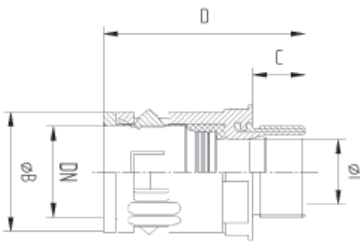

RQGK IP68/IP69K

UL 1696 CSA22.2
File n.E86359
DN 13- 54,5



DIN 5510-2 (S1)



EN/IEC 61386-23



NF F 16-101/102
(I3/F2)



EN 45545-2

HL2



Filettatura Metrica Metric thread

CODICE IP68/IP69K IP68/IP69K CODE	DN ø	ø F	ø l	DIMENSIONI, mm DIMENSIONS, mm			D	CH	kg/100pz	CONFEZIONE PACKAGE
				ø B	C	m				
5012M-0712NM	10	M 12 x 1,5	7	20	10	38,5	18	1,08	50	
5012M-1012NM	13	M 12 x 1,5	7	24	10	40	22	1,50	50	
5012M-1016NM	13	M 16 x 1,5	8,5	24	12	42	22	1,66	50	
5012M-1216NM	15,8	M 16 x 1,5	10	27	12	43,5	25	1,94	50	
5012M-1220NM	15,8	M 20 x 1,5	11	27	12	43,5	25	2,02	50	
5012M-1720NM	21,2	M 20 x 1,5	15	29,5	12	50	28	2,36	25	
5012M-1725NM	21,2	M 25 x 1,5	16	33	13	50	31	3,24	25	
5012M-2325NM	28,5	M 25 x 1,5	18	37	13	53	35	3,84	25	
5012M-2332NM	28,5	M 32 x 1,5	20	41	14	54	39	5,08	25	
5012M-2932NM	34,5	M 32 x 1,5	24	44	14	58	42	5,76	25	
5012M-2940NM	34,5	M 40 x 1,5	27,5	48	17	61	46	6,00	25	
5012M-3640NM	42,5	M 40 x 1,5	32	58	17	76	55	15,8	10	
5012M-3650NM	42,5	M 50 x 1,5	37,5	63	17	76	60	14,5	10	
5012M-4850NM	54,5	M 50 x 1,5	39	68	17	88	65	14,5	10	
5012M-4863NM	54,5	M 63 x 1,5	49	74	17	88	70	23,0	10	

Filettatura Metrica ridotta Reduced metrical thread

CODICE IP68/IP69K IP68/IP69K CODE	DN ø	ø F	ø l	DIMENSIONI, mm DIMENSIONS, mm			D	CH	kg/100pz	CONFEZIONE PACKAGE
				ø B	C	m				
5012M-07125NM	10	M 12 x 1,5	7	20	5	33,5	18	0,80	50	
5012M-10125NM	13	M 12 x 1,5	7	24	5	35	22	1,40	50	
5012M-10165NM	13	M 16 x 1,5	8,5	24	5	35	22	1,55	50	
5012M-12165NM	15,8	M 16 x 1,5	10	27	5	36,5	25	1,80	50	
5012M-12206NM	15,8	M 20 x 1,5	11	27	6	37,5	25	1,96	50	
5012M-17206NM	21,2	M 20 x 1,5	15	29,5	6	44	28	1,96	25	
5012M-17257NM	21,2	M 25 x 1,5	16	33	7	44	31	2,30	25	
5012M-23257NM	28,5	M 25 x 1,5	18	37	7	47	35	4,00	25	
5012M-23327NM	28,5	M 32 x 1,5	20	41	8	47	39	4,00	25	
5012M-29328NM	34,5	M 32 x 1,5	24	44	8	52	42	5,40	25	
5012M-29408NM	34,5	M 40 x 1,5	27,5	48	8	55	46	5,40	25	
5012M-36408NM	42,5	M 40 x 1,5	32	58	8	67	55	7,70	10	
5012M-36509NM	42,5	M 50 x 1,5	37,5	63	9	68	60	13,7	10	
5012M-48509NM	54,5	M 50 x 1,5	39	68	9	80	65	15,0	10	
5012M-48630NM	54,5	M 63 x 1,5	49	74	10	81	70	21,0	10	

Raccordi ad innesto rapido in poliammide Quick-coupler connectors in polyamide

Diritti filetto maschio metallico **5010**

Straight metallic male thread **5010**

Filettatura PG PG thread

CODICE IP68/IP69K IP68/IP69K CODE	DIMENSIONI, mm DIMENSIONS, mm							kg/100pz	CONFEZIONE PACKAGE m
	DN ϕ	ϕ F	ϕ I	ϕ B	C	D	CH		
5010-0707M	10	7	7	20	10	38	18	0,98	50
5010-1009M	13	9	8,5	24	12	42	22	1,58	50
5010-1211M	15,8	11	11	27	12	44	25	2,20	50
5010-1413M	18,5	13,5	12,5	29	12	47,5	26	2,30	50
5010-1716M	21,2	16	16	33	13	51	31	2,68	25
5010-2321M	28,5	21	20	41	14	55	39	5,00	25
5010-2929M	34,5	29	27,5	48	14	59	46	7,20	25
5010-3636M	42,5	36	36	63	17	76	60	13,1	10
5010-4848M	54,5	48	47,5	74	17	88	70	20,4	10

Adattatori girevoli di posizionamento a 45° per raccordi filetto maschio **6028-G** Swivel adapters for positioning at 45° for male thread fittings **6028-G**

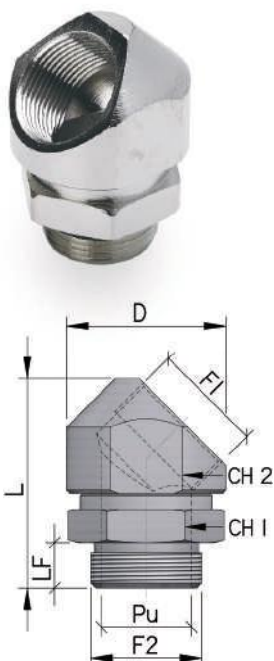

Utilizzabili con tutti i raccordi filetto metrico per tubi metallici o in poliammide. Realizzati in ottone nichelato, questi adattatori di posizionamento consentono di orientare l'uscita dei cavi, per ridurne al minimo lo stress, in condizioni particolari di temperatura e sollecitazioni meccaniche. Una guarnizione interna garantisce la tenuta IP nella connessione girevole. La particolare cura nell'esecuzione assicura un perfetto infilaggio dei cavi senza rischio di danneggiamento del rivestimento. Prodotti con filetto metrico ISO in conformità alla norma CEI EN 60423.

- Standard **CEI EN 61386-1 e 60423**
- Grado di protezione IP CEI EN 60529
IP68 statico / IP67 dinamico

Usable with all metric threaded connectors for metal and polyamide conduits. Made in nickel plated brass, these positioning adapters make it possible to select the direction of cable outlet and to reduce stress to a minimum in particular temperature and mechanical strain conditions. An internal seal guarantees the IP sealing in the swivel connection. The particular care in the execution ensures perfect insertion of cables without risk of damaging the coating. Produced with ISO metric thread in compliance with standards IEC EN 60423.

- Standards **IEC EN 61386-1 and 60423**
- IP degree IEC EN 60529
IP68 static / IP67 dynamic

CODICE CODE	DIMENSIONI, mm DIMENSIONS, mm							kg/pz	CONFEZIONE PACKAGE m	
	F1	F2	LF	L	PU	ϕ D	CH2			CH1
6028-20G	M20x1,5	M20x1,5	10	48	15	34	30	26	0,12	10
6028-25G	M25x1,5	M25x1,5	10	52	20	38	34	32	0,17	10
6028-32G	M32x1,5	M32x1,5	13	60	26	46	41	39	0,26	10
6028-40G	M40x1,5	M40x1,5	14	70	32	55	50	50	0,45	10
6028-50G	M50x1,5	M50x1,5	18	85	39,5	65	56	55	0,64	10
6028-63G	M63x1,5	M63x1,5	18	97	49	80	70	65	1,11	10



Raccordi ad innesto rapido in poliammide

Quick-coupler connectors in polyamide

Diritti filetto femmina 5112 / 5110

Straight plastic female thread 5112 / 5110

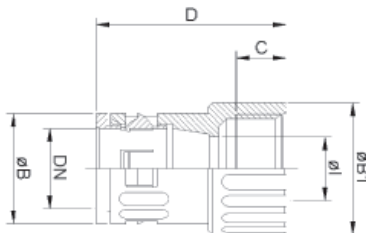

Filettature

- Metrico ISO conforme CEI EN 60423
- PG secondo DIN 40430.

Colori

Nero

Codici di riferimento

RQG3 IP66

RQG2 IP68/IP69K

Threads

- ISO metric compliant IEC EN 60423
- PG in accordance with DIN 40430.

Colour

Black

Reference code

RQG3 IP66

RQG2 IP68/IP69K

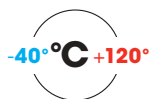

Filettatura Metrica Metric thread

CODICE IP66 IP66 CODE	CODICE IP68/IP69K IP68/IP69K CODE	DN ø	ø F	ø l	DIMENSIONI, mm DIMENSIONS, mm		C	D	CH	kg/100pz	CONFEZIONE PACKAGE m
					ø B	ø B1					
-	5112-07125N67	10	M 12 x 1,5	7,5	17	17	9,5	36,5	16	0,45	50
5112-10125N	5112-10125N67	13	M 12 x 1,5	10	20	23	9,5	34,5	18	0,55	50
5112-1016N	5112-1016N67	13	M 16 x 1,5	10	20	21	9,5	36,5	18	0,64	50
5112-1216N	5112-1216N67	15,8	M 16 x 1,5	12,5	23	21	9,5	39	21	0,76	50
5112-1720N	5112-1720N67	21,2	M 20 x 1,5	16,5	29,5	24	12,5	49	27	1,26	50
5112-2325N	5112-2325N67	28,5	M 25 x 1,5	17	37	30	13,5	54	34	1,40	25
5112-2932N	5112-2932N67	34,5	M 32 x 1,5	24	44	35	15	55,5	40	2,20	10
5112-3640N	5112-3640N67	42,5	M 40 x 1,5	33	58	44,5	20	65	55	2,80	10
-	5112-4850N67	54,5	M 50 x 1,5	48,5	68	54,5	20	86,5	65	4,30	10
-	5112-4863N67	54,5	M 63 x 1,5	48,5	68	69	25	91	65	7,00	10

RQG3 IP66

UL 1696 CSA22.2
File n.E86359
DN 13- 54,5



EN/IEC 61386-23



RQG2 IP68/69K

UL 1696 CSA22.2
File n.E86359
DN 13- 54,5



DIN 5510-2 (S1)



EN/IEC 61386-23



NF F 16-101/102
(I3/F2)



EN 45545-2

HL2



Filettatura PG PG thread

CODICE IP68/IP69K IP68/IP69K CODE	DN ø	ø F	ø l	DIMENSIONI, mm DIMENSIONS, mm		C	D	CH	kg/100pz	CONFEZIONE PACKAGE m
				ø B	ø B1					
5110-1009N67	13	9	10	20,5	21	11,5	33,5	18	0,68	50
5110-1211N67	15,8	11	12,5	23	23	15	39,5	21	1,00	50
5110-1716N67	21,2	16	17	29,5	27,5	16	45	27	1,38	50
5110-2321N67	28,5	21	23,5	37	33,5	22	49	34	2,04	25
5110-2929N67	34,5	29	30,5	44	41	18	52	40	2,60	10
5110-3636N67	42,5	36	36,5	52/58	63/52	20	69/91	49/55	6,80	10
5110-4848N67	54,5	48	45,0	68	64	16	90	65	9,20	10

Raccordi ad innesto rapido in poliammide

Quick-coupler connectors in polyamide

Diritti filetto femmina metallico 5112M / 5110

Straight metallic female thread 5112M / 5110

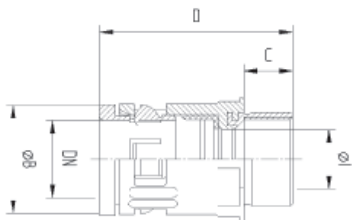

La parte terminale è costituita da un inserto filettato in ottone nichelato.

Indicati per applicazioni in condizioni particolari di temperatura e di sollecitazioni meccaniche.

Filettature

- Metrico ISO conforme CEI EN 60423
- PG secondo DIN 40430.

Colore
Nero

Codici di riferimento
RQGK2 IP68/IP69K

The terminal part consists of a threaded insert in nickel-plated brass.

Suitable for applications in particular temperature and mechanical stresses conditions.

Threads

- ISO metric compliant IEC EN 60423
- PG in accordance with DIN 40430.

Colour
Black

Reference code
RQGK2 IP68/IP69K

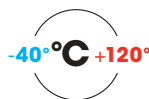

RQGK2 IP68/IP69K

UL 1696 CSA22.2
File n.E86359
DN 13- 54,5



DIN 5510-2 (S1)



EN/IEC 61386-23



NF F 16-101/102
(I3/F2)



EN 45545-2

HL2



Filettatura Metrica Metric thread

CODICE IP68/IP69K IP68/IP69K CODE	DN ø	ø F	ø I	DIMENSIONI, mm DIMENSIONS, mm			D	CH	kg/100pz	CONFEZIONE PACKAGE	
				ø B	C	m					
5112M-0712NM	10	M 12 x 1,5	7	20	7,5	38,5	18	0,90	50		
5112M-1016NM	13	M 16 x 1,5	8,5	24	9	42	22	2,42	50		
5112M-1220NM	15,8	M 20 x 1,5	10	27	10	43,5	25	3,14	50		
5112M-1720NM	21,2	M 20 x 1,5	15	33	11	50	30	4,80	25		
5112M-1725NM	21,2	M 25 x 1,5	16	33	11	50	30	2,60	25		
5112M-2325NM	28,5	M 25 x 1,5	18	43	13	53	41	5,08	25		
5112M-2332NM	28,5	M 32 x 1,5	21	43	13	54	41	4,60	25		
5112M-2932NM	34,5	M 32 x 1,5	24	48	13	58	46	6,88	25		
5112M-2940NM	34,5	M 40 x 1,5	27,5	48	15	60	46	6,30	25		
5112M-3640NM	42,5	M 40 x 1,5	32	58	15	85	55	10,0	10		
5112M-3650NM	42,5	M 50 x 1,5	47,5	79	17	95,5	65	11,0	10		
5112M-4850NM	54,5	M 50 x 1,5	39	68	17	98	65	17,0	10		
5112M-4863NM	54,5	M 63 x 1,5	47,5	79	17	95,5	65	18,6	10		

Filettatura PG a richiesta PG thread on request

CODICE IP68/IP69K IP68/IP69K CODE	DN ø	ø F	ø I	DIMENSIONI, mm DIMENSIONS, mm			D	CH	kg/100pz	CONFEZIONE PACKAGE	
				ø B	C	m					
5110-0707NM	10	7	7	20	8	38	18	0,90	50		
5110-1009NM	13	9	8,5	24	9	42	22	1,50	50		
5110-1211NM	15,8	11	11	27	9	44	25	2,30	50		
5110-1413NM	18,5	13,5	12,5	29	9,5	47,5	26	2,64	50		
5110-1716NM	21,2	16	16	33	13	51	31	3,16	25		
5110-2321NM	28,5	21	20	41	13	55	39	4,40	25		
5110-2929NM	34,5	29	27,5	48	14	59	46	6,84	25		
5110-3636NM	42,5	36	36	60	16	85	55	10,3	10		
5110-4848NM	54,5	48	42,5	72	16	98	65	13,6	10		

■ Raccordi ad innesto rapido in poliammide Quick-coupler connectors in polyamide

Diritti filetto femmina plastico per connettori **5100**

Straight plastic female thread for connectors **5100**

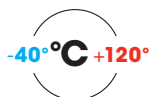
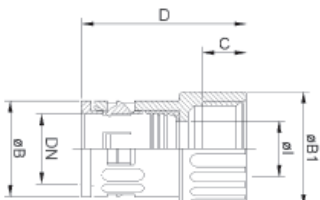

Consentono il collegamento tra i tubi flessibili in poliammide e i più comuni connettori: AMP – MIL – BURNDY
Sono prodotti con filettatura tipo UNEF secondo le norme ANSI/ASME B1.1

Colore
Nero

Codice di riferimento
RQG2 IP68/IP69K

Allow the connection between polyamide flexible conduit and the most common connectors: AMP – MIL – BURNDY
Are manufactured with a UNEF thread in compliance with ANSI/ASME B1.1

Colour
Black

Reference code
RQG2 IP68/IP69K

RQG2 IP68/69K

UL 1696 CSA22.2
File n.E86359
DN 13- 54,5



DIN 5510-2 (S1)



EN/IEC 61386-23



NF F 16-101/102
(I3/F2)



CSA 22.2
File n. 227.3-05



EN 45545-2

HL2



CODICE IP68/IP69K IP68/IP69K CODE	DIMENSIONI, mm DIMENSIONS, mm									CONFEZIONE PACKAGE
	DN ø	ø F	ø l	ø B	ø B1	C	D	CH	kg/100pz	
5100-10001228N8	13	1/2" - 28	10	20	17	8	36,6	18	0,50	50
5100-10005824N8	13	5/8" - 24	10	20	20,6	8	36,6	18	0,60	50
5100-10003420N8	13	3/4" - 20	10	20	23	9,5	38,5	18	0,70	50
5100-12005824N8	15,8	5/8" - 24	12,5	23	23,6	9,5	40	21	0,76	50
5100-12111624N8	15,8	11/16" - 24	12,5	23	23,6	9,5	46	21	0,80	50
5100-12003420N8	15,8	3/4" - 20	12,5	23	23,6	9,5	41,7	21	0,94	50
5100-12151620N8	15,8	15/16" - 20	12,5	23	30	9,5	45,5	21	1,30	50
5100-12000120N8	15,8	1" - 20	12,5	23	30	9,5	45,5	21	1,10	50
5100-17091624N8	21,2	9/16" - 24	12,5	29,5	20	8	44,6	27	1,10	50
5100-17005824N8	21,2	5/8" - 24	12,5	29,5	30,1	9,5	45	27	1,10	50
5100-17003420N8	21,2	3/4" - 20	12,5	29,5	30	9,5	51,5	27	1,40	50
5100-17007820N8	21,2	7/8" - 20	17	29,5	29,5	9,5	50,5	27	1,54	50
5100-17151620N8	21,2	15/16" - 20	17	29,5	30,1	9,5	50,3	27	1,78	50
5100-17000120N8	21,2	1" - 20	17	29,5	30,1	9,5	50,3	27	1,72	50
5100-17011820N8	21,2	1" 1/8 - 18	17	29,5	33,5	9,5	52,5	27	1,70	50
5100-17131618N8	21,2	1" 3/16 - 18	17	29,5	34,6	9,5	52,3	27	1,98	50
5100-17013818N8	21,2	1" 3/8 - 18	17	29,5	41	9,5	52,5	27	2,20	50
5100-17171618N8	21,2	1" 7/16 - 18	17	29,5	41	9,5	52,5	27	1,90	50
5100-17013418N8	21,2	1" 3/4 - 18	17	29,5	49	9,5	52,5	27	2,56	50
5100-23151620N8	28,5	15/16" - 20	17	37	37	9,5	52,5	34	1,08	25
5100-23000120N8	28,5	1" - 20	23,5	37	37	9,5	54	34	2,20	25
5100-23131618N8	28,5	1" 3/16 - 18	23,5	37	37	9,5	52,5	34	2,24	25
5100-23013818N8	28,5	1" 3/8 - 18	23,5	37	41	9,5	54	34	2,68	25
5100-23171618N8	28,5	1" 7/16 - 18	23,5	37	41	9,5	54	34	2,48	25
5100-23013418N8	28,5	1" 3/4 - 18	23,5	37	49	9,5	54	34	3,00	25
5100-29000120N8	34,5	1" - 20	23,5	44	43,5	9,5	56	40	2,30	10
5100-29131618N8	34,5	1" 3/16 - 18	17	44	43,5	9,5	56	40	3,00	10
5100-29013818N8	34,5	1" 3/8 - 18	23,5	44	52	9,5	56	40	3,20	10
5100-29171618N8	34,5	1" 7/16 - 18	30,5	44	44	9,5	55	40	1,80	10
5100-29015818N8	34,5	1" 5/8 - 18	30,5	44	46	9,5	56	40	2,20	10
5100-29013418N8	34,5	1" 3/4 - 18	30,5	44	49	9,5	56	40	2,90	10
5100-29000218N8	34,5	2" - 18	30,5	44	55	9,5	56	40	3,20	10
5100-36131618N8	42,5	1" 3/16 - 18	23	52	52	9,5	56	48	4,10	10
5100-36171618N8	42,5	1" 7/16 - 18	30,5	52	52	9,5	57	48	3,10	10
5100-36013418N8	42,5	1" 3/4 - 18	30,5	52	52	9,5	58,5	48	4,20	10
5100-36000218N8	42,5	2" - 18	30,5	52	54,5	9,5	60	49	4,30	10
5100-36021416N8	42,5	2" 1/4 - 16	30,5	52	66,5	18	70	48	5,50	10
5100-48021416N8	54,5	2" 1/4 - 16	49,5	64	66,5	18	70	60	6,10	10

■ Raccordi in poliammide Polyamide fittings

Per sensori **5061 / 5062**

For sensors **5061 / 5062**

Prodotti in poliammide di alta qualità, autoestinguenti, sono utilizzati per il collegamento dei sensori con led luminosi. A tale scopo sono prodotti in poliammide trasparente.

La tenuta IP65 si ottiene inserendo una guarnizione O-ring nel primo solco dell'ondulazione del tubo flessibile. Il collegamento tra adattatore e tubo flessibile avviene mediante l'escursione assiale di un particolare anello che blocca il tubo all'interno del raccordo. Filettatura tipo Metrico ISO in conformità con le norme CEI EN 60423.

Made of high quality polyamide, self-extinguishing, are used to connect sensors with LEDs.

For this purpose these adapters are produced in transparent polyamide.

IP65 seal is obtained by inserting an O-ring in the first groove of the corrugation of flexible conduit.

The connection between the adapter and flexible conduit occurs by axial excursion of a particular ring that secures the conduit inside the connector.

Produced with Metric ISO thread in compliance with IEC EN 60423.

Dritto Straight

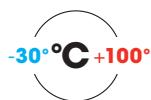

CODICE CODE	DIAMETRO NOMINALE NOMINAL DIAMETER	DIMENSIONI, mm DIMENSIONS, mm		CONFEZIONE PACKAGE
		ø F	L	
5061-070838N	10	8 x 1	39	50
5061-070853N	10	8 x 1	53	50
5061-071238N	10	12 x 1	39	50
5061-071253N	10	12 x 1	53	50
5061-071853N	10	18 x 1	53	50
5061-073053N	10	30 x 1,5	53	50
5061-100865N	13	8 x 1	65	50
5061-101265N	13	12 x 1	65	50
5061-101865N	13	18 x 1	65	50
5061-103065N	13	30 x 1,5	65	50

A 90° At 90°



CODICE CODE	DIAMETRO NOMINALE NOMINAL DIAMETER	DIMENSIONI, mm DIMENSIONS, mm		CONFEZIONE PACKAGE
		ø F	L	
5062-070846N	10	8 x 1	46	50
5062-070860N	10	8 x 1	60	50
5062-071246N	10	12 x 1	46	50
5062-071260N	10	12 x 1	60	50
5062-071860N	10	18 x 1	60	50
5062-073060N	10	30 x 1,5	60	50

■ Raccordi in poliammide Polyamide fittings

Curvi 90° filetto maschio plastico fisso 5029

Elbow 90° fixed plastic male thread 5029



Filettature

- Metrico ISO conforme CEI EN 60423
- PG secondo DIN 40430

Colore

Nero

Codici di riferimento

RQB90 IP68/IP69K
RQB1 90-M IP68/IP69K

Threads

- ISO metric compliant IEC EN 60423
- PG in accordance with DIN 40430.

Colour

Black

Reference code

RQB90 IP68/IP69K
RQB1 90-M IP68/IP69K

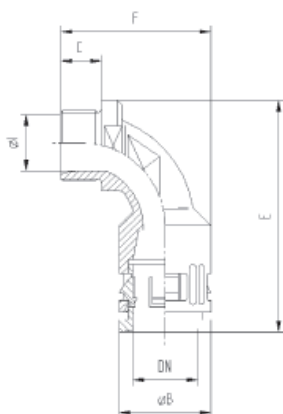

RQB1 90-M IP68/IP69K

UL 1696 CSA22.2
File n.E86359
DN 13- 54,5



EN/IEC 61386-23



RQB90 IP68/69K

UL 1696 CSA22.2
File n.E86359
DN 13- 54,5



DIN 5510-2 (S1)



EN/IEC 61386-23



NF F 16-101/102
(I3/F2)



EN 45545-2

HL2



Filettatura Metrica Metric thread

CODICE IP66 IP66 CODE	CODICE IP68/IP69K IP68/IP69K CODE	DIMENSIONI, mm DIMENSIONS, mm								CONFEZIONE PACKAGE	
		DN ø	ø F	ø I	ø B	C	E	F	CH	kg/100pz	pz pcs
5029M-0712N	5029-0712N	10	M 12 x 1,5	6,5	17	10	57	39	18	0,86	50
5029M-1016N	5029-1016N	13	M 16 x 1,5	8,5	20	12	59	40,5	21	1,10	50
5029M-1220N	5029-1220N	15,8	M 20 x 1,5	10	23	12	62	45	24	1,44	50
5029M-1720N	5029-1720N	21,2	M 20 x 1,5	13	29,5	12	73	48	26	2,08	50
5029M-1725N	5029-1725N	21,2	M 25 x 1,5	14,5	29,5	13	73	48	26	2,20	50
5029M-2325N	5029-2325N	28,5	M 25 x 1,5	17	37	13	90	64	32	3,32	25
5029M-2332N	5029-2332N	28,5	M 32 x 1,5	20	37	14	85	64	36	3,56	25
5029M-2932N	5029-2932N	34,5	M 32 x 1,5	23	44	14	100,5	74	39	5,00	10
5029M-2940N	5029-2940N	34,5	M 40 x 1,5	29	44	14	100,5	74	45	5,40	10
5029M-3640N	5029-3640N	42,5	M 40 x 1,5	31,5	52	17	111	82,5	48	7,00	10
5029M-3650N	5029-3650N	42,5	M 50 x 1,5	36	52	17	111	82,5	59	9,10	10
5029M-4850N	5029-4850N	54,5	M 50 x 1,5	35,5	64	17	124,5	98	60	11,0	5
5029M-4863N	5029-4863N	54,5	M 63 x 1,5	45,5	64	17	124,5	97	70	10,0	5

Filettatura PG PG thread

CODICE IP68/IP69K IP68/IP69K CODE	DN ø	ø F	ø I	DIMENSIONI, mm DIMENSIONS, mm			F	CH	kg/100pz	CONFEZIONE PACKAGE
				ø B	C	E				
5029-0707N	10	7	6,5	17	10	57	39	18	0,88	50
5029-1009N	13	9	8,5	20	12	59	40,5	21	1,00	50
5029-1211N	15,8	11	10	23	12	62	45	24	1,30	50
5029-1413N	18,5	13,5	12,5	25	12	65	47	27	1,70	50
5029-1716N	21,2	16	14,5	29,5	13	73	48	26	2,06	50
5029-2321N	28,5	21	20	37	14	85	64	36	3,32	25
5029-2929N	34,5	29	29	44	14	100,5	74	46	5,20	10
5029-3636N	42,5	36	36	52	17	111	82,5	58	8,80	10
5029-4848N	54,5	48	45,5	64	17	124,5	97	70	11,6	5

Raccordi in poliammide Polyamide fittings

Curvi 90° filetto maschio metallico fisso 5029

Elbow 90° fixed plastic male thread 5029



La parte terminale è costituita da un inserto filettato in ottone nichelato.

Indicati per applicazioni in condizioni particolari di temperatura e di sollecitazioni meccaniche.

The terminal part consists of a threaded insert in nickel-plated brass.

Suitable for applications in particular temperature and mechanical stresses conditions.

Filettature

- Metrico ISO conforme CEI EN 60423
- PG secondo DIN 40430

Threads

- ISO metric compliant IEC EN 60423
- PG in accordance with DIN 40430.

Colore

Nero

Colour

Black

Codici di riferimento

RQBK90 IP68/IP69K

Reference code

RQBK90 IP68/IP69K

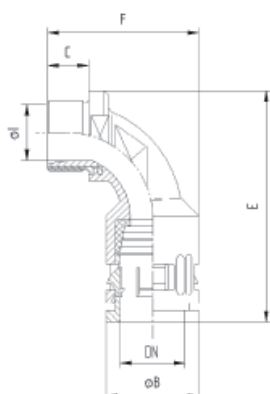

RQBK90 IP68/IP69K

UL 1696 CSA22.2
File n.E86359
DN 13- 54,5



DIN 5510-2 (S1)



EN/IEC 61386-23



NF F 16-101/102
(I3/F2)



EN 45545-2

HL2



Filettatura Metrica Metric thread

CODICE IP68/IP69K IP68/IP69K CODE	DN ø	ø F	ø I	DIMENSIONI, mm DIMENSIONS, mm				CH	kg/100pz	CONFEZIONE PACKAGE pz pcs
				ø B	C	E	F			
5029-0712NM	10	M 12 x 1,5	6,5	17	10	57	39	18	1,48	50
5029-1016NM	13	M 16 x 1,5	8,5	20	12	59	40,5	21	1,40	50
5029-1220NM	15,8	M 20 x 1,5	10	23	12	62	45	24	2,40	50
5029-1720NM	21,2	M 20 x 1,5	13	29,5	12	73	48	26	3,00	50
5029-1725NM	21,2	M 25 x 1,5	14,5	29,5	13	73	48	26	3,50	50
5029-2325NM	28,5	M 25 x 1,5	17	37	13	90	64	32	4,84	25
5029-2332NM	28,5	M 32 x 1,5	20	37	14	85	64	36	6,04	25
5029-2932NM	34,5	M 32 x 1,5	23	44	14	100,5	74	39	8,00	10
5029-2940NM	34,5	M 40 x 1,5	29	44	14	100,5	74	45	8,00	10
5029-3640NM	42,5	M 40 x 1,5	31,5	52	17	111	82,5	48	16,0	10
5029-3650NM	42,5	M 50 x 1,5	36	52	17	111	82,5	59	16,0	10
5029-4850NM	54,5	M 50 x 1,5	35,5	64	17	124,5	98	60	19,0	5
5029-4863NM	54,5	M 63 x 1,5	45,5	64	17	124,	98	70	22,5	5

Filettatura PG PG thread

CODICE IP68/IP69K IP68/IP69K CODE	DN ø	ø F	ø I	DIMENSIONI, mm DIMENSIONS, mm				CH	kg/100pz	CONFEZIONE PACKAGE pz pcs
				ø B	C	E	F			
5029-0707NM	10	7	6,5	17	10	57	39	18	1,34	50
5029-1009NM	13	9	8,5	20	12	59	40,5	21	1,92	50
5029-1211NM	15,8	11	10	23	12	62	45	24	2,64	50
5029-1413NM	18,5	13,5	12,5	25	12	65	47	27	2,86	50
5029-1716NM	21,2	16	14,5	29,5	13	73	48	26	3,08	50
5029-2321NM	28,5	21	20	37	14	85	64	36	5,76	25
5029-2929NM	34,5	29	29	44	14	100,5	74	46	8,80	10
5029-3636NM	42,5	36	36	52	17	111	82,5	58	14,8	10
5029-4848NM	54,5	48	45,5	64	17	124,5	97	70	21,8	5

Raccordi in poliammide Polyamide fittings

Curvo 90° filetto metallico girevole 5029

Elbow 90° metallic swivel thread 5029



La parte terminale è costituita da un inserto filettato maschio in ottone nichelato. Indicati per applicazioni in condizioni particolari di temperatura e di sollecitazioni meccaniche.

The terminal part consists of a male threaded insert in nickel-plated brass. Suitable for applications in particular temperature and mechanical stresses conditions.

Filettature

- Metrico ISO conforme CEI EN 60423
- PG secondo DIN 40430

Threads

- ISO metric compliant IEC EN 60423
- PG in accordance with DIN 40430.

Colori

Nero

Colours

Black

Codici di riferimento

RQBK90DR IP68/IP69K

Reference code

RQBK90DR IP68/IP69K

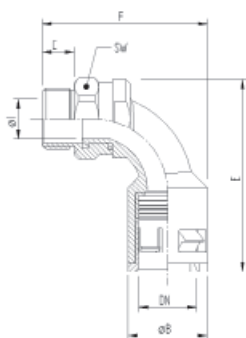

Filettatura Metrica Metric thread

CODICE IP68/IP69K IP68/IP69K CODE	DIMENSIONI, mm DIMENSIONS, mm								CONFEZIONE PACKAGE	
	DN ø	ø F	ø I	ø B	C	E	F	CH	kg/100pz	pz pcs
5029-1720NMG	21,2	M 20 x 1,5	13	29,5	12	72	62	27	6,20	50
5029-2325NMG	28,5	M 25 x 1,5	17	37	13	90	80	34	11,16	25
5029-2932NMG	34,5	M 32 x 1,5	24,5	44	14	100	91	43	16,50	10
5029-3640NMG	42,5	M 40 x 1,5	31,5	52	17	111	103	52	28,40	10



RQBK90DR IP68/IP69K

UL 1696 CSA22.2
File n.E86359
DN 13- 54,5



DIN 5510-2 (S1)



EN/IEC 61386-23



NF F 16-101/102
(I3/F2)



EN 45545-2

HL2



Filettatura PG PG thread

CODICE IP68/IP69K IP68/IP69K CODE	DIMENSIONI, mm DIMENSIONS, mm								CONFEZIONE PACKAGE	
	DN ø	ø F	ø I	ø B	C	E	F	CH	kg/100pz	pz pcs
5029-1716NMG	21,2	16	13	29,5	13	72	62	27	6,22	50
5029-2321NMG	28,5	21	17	37	14	85	79	34	11,0	25
5029-2929NMG	34,5	29	24,5	44	14	100	91	43	16,0	10
5029-3636NMG	42,5	36	31,5	52	17	110	103	52	32,9	10

Raccordi in poliammide

Polyamide fittings

Curvo 45° filetto maschio 5028

Elbow 45° male thread 5028



Filettature

- Metrico ISO conforme CEI EN 60423
- PG secondo DIN 40430

Colori

Nero

Codici di riferimento

RQB1 45 IP66
RQB 45 IP68/IP69K

Threads

- ISO metric compliant IEC EN 60423
- PG in accordance with DIN 40430

Colour

Black

Reference code

RQB1 45 IP66
RQB 45 IP68/IP69K

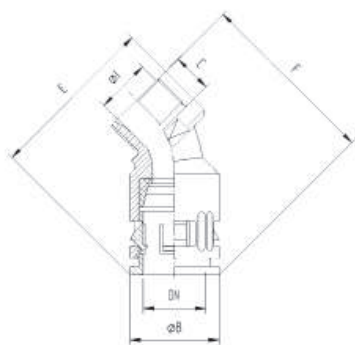

RQB1 45 IP66

UL 1696 CSA22.2
File n.E86359
DN 13- 54,5



EN/IEC 61386-23



RQB 45 IP68/IP69K

UL 1696 CSA22.2
File n.E86359
DN 13- 54,5



DIN 5510-2 (S1)



EN/IEC 61386-23



NF F 16-101/102
(I3/F2)



EN 45545-2

HL2



Filettatura Metrica Metric thread

CODICE IP66 IP66 CODE	CODICE IP68/IP69K IP68/IP69K CODE	DN ø	ø F	DIMENSIONI, mm DIMENSIONS, mm					F	CH	kg/100pz	CONFEZIONE PACKAGE pz pcs
				ø I	ø B	C	E					
5028M-0712N	5028-0712N	10	M 12 x 1,5	6,5	17	10	39	45	18	0,68	50	
5028M-1016N	5028-1016N	13	M 16 x 1,5	8,5	20	12	42,5	48	21	0,80	50	
5028M-1220N	5028-1220N	15,8	M 20 x 1,5	10	23	12	44,5	52,5	24	1,30	50	
5028M-1720N	5028-1720N	21,2	M 20 x 1,5	13	29,5	12	55	60	26	1,70	50	
5028M-1725N	5028-1725N	21,2	M 25 x 1,5	14,5	29,5	13	56	60	26	2,90	25	
5028M-2325N	5028-2325N	28,5	M 25 x 1,5	17	37	13	64	72	32	2,64	25	
5028M-2332N	5028-2332N	28,5	M 32 x 1,5	20	37	14	64	75	36	2,90	25	
5028M-2932N	5028-2932N	34,5	M 32 x 1,5	23	44	14	73,5	76	39	4,00	10	
5028M-2940N	5028-2940N	34,5	M 40 x 1,5	29	44	14	73,5	77	45	4,20	10	
5028M-3640N	5028-3640N	42,5	M 40 x 1,5	31,5	52	17	82,5	86	48	5,50	10	
5028M-3650N	5028-3650N	42,5	M 50 x 1,5	36	52	17	82,5	86	58	6,50	10	
5028M-4850N	5028-4850N	54,5	M 50 x 1,5	35,5	64	17	92	95	58	8,50	5	
5028M-4863N	5028-4863N	54,5	M 63 x 1,5	45,5	64	17	97	100	69	9,20	5	

Filettatura PG PG thread

CODICE IP68/IP69K IP68/IP69K CODE	DN ø	ø F	ø I	DIMENSIONI, mm DIMENSIONS, mm					F	CH	kg/100pz	CONFEZIONE PACKAGE pz pcs
				ø B	C	E						
5028-0707N	10	7	6,5	17	10	39	45	18	0,66	50		
5028-1009N	13	9	8,5	20	12	42,5	48	21	0,80	50		
5028-1211N	15,8	11	10	23	12	44,5	52,5	24	1,22	50		
5028-1413N	18,5	13,5	12,5	25	12	49	59	27	1,42	50		
5028-1716N	21,2	16	14,5	29,5	13	56	60	26	1,70	50		
5028-2321N	28,5	21	20	37	14	64	75	36	2,90	25		
5028-2929N	34,5	29	29	44	14	73,5	77	45	4,00	10		
5028-3636N	42,5	36	36	52	17	82,5	86	58	6,50	10		
5028-4848N	54,5	48	45,5	64	17	97	100	70	8,50	5		

Raccordi in poliammide Polyamide fittings

A gomito 90° filetto maschio plastico 5022 / 5020 Elbow 90° plastic male thread 5022 / 5020



Filettature

- Metrico ISO conforme CEI EN 60423
- PG secondo DIN 40430
- GAS cilindrico UNI ISO 228
- NPT conforme norme ANSI B2.1

Colore
Nero

Codici di riferimento
RQW IP68/IP69K
RQW1 IP66

Threads

- ISO metric compliant IEC EN 60423
- PG in accordance with DIN 40430
- UNI ISO 228 GAS cylindrical
- NPT in compliance with ANSI B2.1.

Colour
Black

Reference code
RQW IP68/IP69K
RQW1 IP66

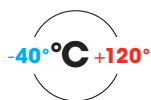
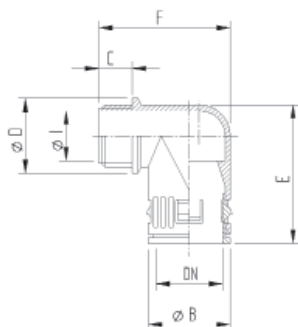

RQW IP68/IP69K

UL 1696 CSA22.2
File n.E86359
DN 13- 54,5



RQW1 IP66

UL 1696 CSA22.2
File n.E86359
DN 13- 54,5



DIN 5510-2 (S1)



EN/IEC 61386-23



NF F 16-101/102
(I3/F2)



EN 45545-2

HL2



Filettatura Metrica Metric thread

CODICE IP66 IP66 CODE	CODICE IP68/IP69K IP68/IP69K CODE	DN ø	ø F	DIMENSIONI, mm DIMENSIONS, mm					Ø D	kg/100pz	CONFEZIONE PACKAGE pz pcs
				ø l	ø B	C	E	F			
5022-0710N	5022-0710N67	10,0	M 10 x 1,0	6	17	12	33,5	34,5	16	0,60	50
5022-0712N	5022-0712N67	13,0	M 12 x 1,5	8	20	10	36	34	20	0,76	50
5022-1016N	5022-1016N67	13,0	M 16 x 1,5	12	20	12	36	36,5	20	0,72	50
5022-1216N	5022-1216N67	15,8	M 16 x 1,5	12	23	12	42	40,5	24,5	1,08	50
5022-1220N	5022-1220N67	15,8	M 20 x 1,5	15,5	23	13	42	41,5	24,5	1,06	50
5022-1720N	5022-1720N67	21,2	M 20 x 1,5	14,8	29,5	13	50	49	27	2,00	50
5022-1725N	5022-1725N67	21,2	M 25 x 1,5	18	29,5	13	50	49	29,5	1,94	50
5022-2325N	5022-2325N67	28,5	M 25 x 1,5	18	37	13	57	57	34	3,12	25
5022-2332N	5022-2332N67	28,5	M 32 x 1,5	24	37	15	57	59	37	3,04	25
5022-2932N	5022-2932N67	34,5	M 32 x 1,5	24	44	15	67,5	65	43	4,08	10
5022-2940N	5022-2940N67	34,5	M 40 x 1,5	32	44	15	67,5	67	45	4,40	10
5022-3640N	5022-3640N67	42,5	M 40 x 1,5	32	52	15	83	72	51,5	7,00	10
5022-3650N	5022-3650N67	42,5	M 50 x 1,5	39	52	15,5	83	74,5	55	7,30	10
5022-4850N	5022-4850N67	54,5	M 50 x 1,5	39	64	15	94	84	64	11,4	5
5022-4863N	5022-4863N67	54,5	M 63 x 1,5	53	64	16	94	85,5	68	10,8	5

Filettatura PG PG thread

CODICE IP66 IP66 CODE	CODICE IP68/IP69K IP68/IP69K CODE	DN ø	ø F	ø l	DIMENSIONI, mm DIMENSIONS, mm					Ø D	kg/100pz	CONFEZIONE PACKAGE pz pcs
					ø B	C	E	F				
5020-0707N	5020-0707N67	10,0	7	7	17	9,5	34	33	16	0,56	50	
5020-1009N	5020-1009N67	13,0	9	12	20	10	37	34	20	0,68	50	
-	5020-1011N67	13,0	11	14	20	10	39	34	23	0,78	50	
-	5020-1013N67	15,8	13,5	15,5	20	10	41	35	25	0,86	50	
5020-1211N	5020-1211N67	15,8	11	15,5	23	10	42	37,5	24,5	1,00	50	
5020-1413N	5020-1413N67	18,5	13,5	13,5	26,5	13	46	47	27	1,40	50	
5020-1716N	5020-1716N67	21,2	16	18	29,5	13	50	48	27	1,80	50	
5020-2321N	5020-2321N67	28,5	21	24	37	13	58	56	34	2,84	25	
5020-2929N	5020-2929N67	28,5	29	32	44	15	67,5	65	43	4,20	10	
5020-3636N	5020-3636N67	34,5	36	36,5	52	15	83	72	51,5	7,20	10	
5020-4848N	5020-4848N67	34,5	48	48,5	64	16	96	84	65	10,2	5	

■ Raccordi in poliammide Polyamide fittings

A gomito 90° filetto maschio plastico **5021 / 5023**

Elbow fittings 90° plastic male thread **5021 / 5023**

Filettatura GAS ISO 228 GAS ISO 228 thread

CODICE IP68/IP69K IP68/IP69K CODE	DN ø	ø F	ø l	DIMENSIONI, mm DIMENSIONS, mm					ø D	kg/100pz	CONFEZIONE PACKAGE pz pcs
				ø B	C	E	F				
5021-10012N67	13,0	1/2"	15	20	14	40	40	27	0,98	50	
5021-12012N67	15,8	1/2"	15	23	14	42	43	27	1,12	50	
5021-17012N67	21,2	1/2"	15	29,5	13	51	49	27	2,00	50	
5021-23034N67	28,5	3/4"	20,5	37	13	57	57	34	3,00	25	
5021-29001N67	34,5	1"	25	44	16	67,5	66,5	43	4,90	10	
5021-36114N67	42,5	1"1/4	35	52	18	83	76	52	7,05	10	
5021-48002N67	54,5	2"	52	64	18	96	89,5	66	10,2	5	

Filettatura NPT NPT thread

CODICE IP68/IP69K IP68/IP69K CODE	DN ø	ø F	ø l	DIMENSIONI, mm DIMENSIONS, mm					ø D	kg/100pz	CONFEZIONE PACKAGE pz pcs
				ø B	C	E	F				
5023-07014N	10	1/4"	8,5	17	10	34	33	16	0,40	50	
5023-10014N	13	1/4"	10	20	10,5	36	35	20	0,60	50	
5023-12038N	15,8	3/8"	12,5	23	12	42	40,5	24,5	0,80	50	
5023-12012N	15,8	1/2"	16	26	11	42	40,5	26	1,10	50	
5023-21012N	21,2	1/2"	16	29,5	13	51	48,5	27	1,88	50	
5023-22034N	28,5	3/4"	21	37	14	57,5	57	34	3,04	25	
5023-28001N	34,5	1"	28	44	16	67,5	66	43	4,80	10	
5023-36114N	42,5	1"1/4	35	52	18	83	76	52	5,20	10	
5023-36112N	42,5	1"1/2	36,5	54	16,5	83	76	56	5,50	10	
5023-48112N	54,5	1"1/2	41	64	18	95	87	64,5	14,0	5	
5023-48002N	54,5	2"	52	66	21	100	90	65	14,8	5	

■ Raccordi in poliammide Polyamide fittings

Curvo 45° filetto maschio 5028

Elbow 45° plastic thread 5028



La parte terminale è costituita da un inserto filettato in ottone nichelato. Indicati per applicazioni in condizioni particolari di temperatura e di sollecitazioni meccaniche.

The terminal part consists of a threaded insert in nickel-plated brass. Suitable for applications in particular temperature and mechanical stresses conditions.

Filettature

- Metrico ISO conforme CEI EN 60423
- PG secondo DIN 40430

Threads

- ISO metric compliant IEC EN 60423
- PG in accordance with DIN 40430

Colore

Nero

Colour

Black

Codici di riferimento

RQBK45 IP68/IP69K

Reference code

RQBK45 IP68/IP69K

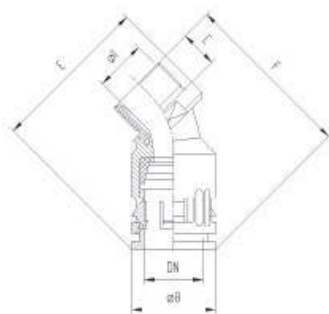

Filettatura Metrica Metric thread

CODICE IP68/IP69K IP68/IP69K CODE	DN ø	ø F	ø I	DIMENSIONI, mm DIMENSIONS, mm				CH	kg/100pz	CONFEZIONE PACKAGE	
				ø B	C	E	F			pz	pcs
5028-0712NM	10	M 12 x 1,5	6,5	17	10	39	45	18	1,14	50	
5028-1016NM	13	M 16 x 1,5	8,5	20	12	42,5	48	21	1,76	50	
5028-1220NM	15,8	M 20 x 1,5	10	23	12	44,5	52,5	24	1,70	50	
5028-1720NM	21,2	M 20 x 1,5	13	29,5	12	55	60	26	2,54	50	
5028-1725NM	21,2	M 25 x 1,5	14,5	29,5	13	56	60	26	3,80	50	
5028-2325NM	28,5	M 25 x 1,5	17	37	13	64	72	32	4,52	25	
5028-2332NM	28,5	M 32 x 1,5	20	37	14	64	75	36	5,64	25	
5028-2932NM	34,5	M 32 x 1,5	23	44	14	73,5	76	39	6,70	10	
5028-2940NM	34,5	M 40 x 1,5	29	44	14	73,5	77	45	9,00	10	
5028-3640NM	42,5	M 40 x 1,5	31,5	52	17	82,5	86	48	8,70	10	
5028-3650NM	42,5	M 50 x 1,5	36	52	17	82,5	86	58	16,5	10	
5028-4850NM	54,5	M 50 x 1,5	35,5	64	17	92	95	58	17,4	5	
5028-4863NM	54,5	M 63 x 1,5	45,5	64	17	97	100	69	22,5	5	

RQBK45 IP68/IP69K

UL 1696 CSA22.2
File n.E86359
DN 13- 54,5



DIN 5510-2 (S1)



EN/IEC 61386-23



NF F 16-101/102
(I3/F2)



EN 45545-2

HL2



Filettatura PG PG thread

CODICE IP68/IP69K IP68/IP69K CODE	DN ø	ø F	ø I	DIMENSIONI, mm DIMENSIONS, mm				CH	kg/100pz	CONFEZIONE PACKAGE	
				ø B	C	E	F			pz	pcs
5028-0707NM	10	7	6,5	17	10	39	45	18	1,00	50	
5028-1009NM	13	9	8,5	20	12	42,5	48	21	1,70	50	
5028-1211NM	15,8	11	10	23	12	44,5	52,5	24	2,30	50	
5028-1413NM	18,5	13,5	12,5	25	12	49	59	27	2,62	50	
5028-1716NM	21,2	16	14,5	29,5	13	56	60	26	2,86	50	
5028-2321NM	28,5	21	20	37	14	64	75	36	5,36	25	
5028-2929NM	34,5	29	29	44	14	73,5	77	45	7,70	10	
5028-3636NM	42,5	36	36	52	17	82,5	86	58	12,3	10	
5028-4848NM	54,5	48	45,5	64	17	97	100	70	18,0	5	

■ Raccordi in poliammide Polyamide fittings

A gomito flangiato 5027 Flanged elbow 5027

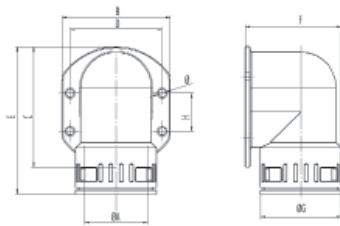

Colore
Nero

Colour
Black

Codici di riferimento
RQW-F

Reference code
RQW-F

CODICE IP68/IP69K IP68/IP69K CODE	DIMENSIONI, mm DIMENSIONS, mm											CONFEZIONE PACKAGE	
	DN ø	ø A	B	C	D	F	G	H	ø	E	kg/100pz	pz pcs	
5027-23N67	28,5	27	65,5	61	53	45	37	-	6,6	88	5,20	10	
5027-29N67	34,5	33	67	77	54	50	44	36	6,6	110	5,70	10	
5027-36N67	42,5	38	85	84,5	73	64,5	52	30	6,6	104	7,80	10	
5027-48N67	54,5	50	86	100	73	76	64	30	6,6	121	10,3	10	

Raccordi flangiati 5027 Flanged fittings 5027



La parte terminale è provvista di fori per il fissaggio su superfici piane, mediante l'utilizzo di viti.

La tenuta IP68 è garantita da una guarnizione O-ring alloggiata sulla superficie piana della flangia.

The end part is provided with holes for mounting on flat surfaces, through the use of screws.

The seal IP68 is guaranteed by an O-ring located on the flat surface of the flange.

Filettature

- Metrico ISO conforme CEI EN 60423

Threads

- ISO metric compliant IEC EN 60423

Colori

Nero

Colours

Black

Codici di riferimento
RQF2-M

Reference code
RQF2-M

CODICE IP68/IP69K IP68/IP69K CODE	DIMENSIONI, mm DIMENSIONS, mm											CONFEZIONE PACKAGE	
	DN ø	DN ø	ø F	B	C	D	ø E	F	G	H	ø	kg/100pz	pz pcs
5027-M25N	21,2	28,5	M25x1,5	46	32	36	29,5	15,5	-	13	5,4	0,66	50
5027-M32N	28,5	34,5	M32x1,5	63	46	52	37	19	-	16,5	6,6	1,48	25
5027-M40N	34,5	42,5	M40x1,5	67	55	54	45	18,5	36	16	6,6	1,90	10
5027-M50N	42,5	54,5	M50x1,5	86	64	73	55	20	30	17	6,6	2,50	10
5027-M50N	54,5	-	M63x1,	86	70	73	68	20	30	17	6,6	2,80	5

■ Raccordi in poliammide Polyamide fittings

Flangiato tipo multi 5014

Flanged multi type 5014

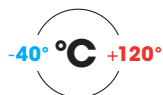
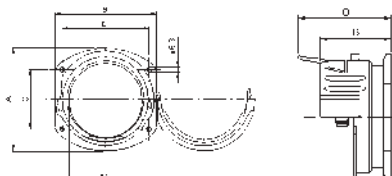

UL 1696 CSA22.2
File n.E86359



- Standard
CEI EN 61386-1, 61386-23 ed EN 60204
- Non propagante la fiamma (CEI EN 61386)
- Grado di protezione standard IP54
IP65 con guarnizione supplementare;
IP68 / IP69K con guarnizione
supplementare in TPE

Colore
Nero

Codici di riferimento
MULTI-GFP IP54

- Standard
IEC EN 61386-1, 61386-23 and EN 60204
- No flame propagation (IEC EN 61386)
- IP protection degree IP54
IP65 with supplementary seal;
IP68 / IP69K with supplementary seal
in TPE

Colour
Black

Reference code
MULTI-GFP IP54

CODICE IP54 IP54 CODE	DIMENSIONI, mm DIMENSIONS, mm							kg/100pz	CONFEZIONE PACKAGE pz pcs
	DN ϕ	ϕ A	ϕ B	C	D	ϕ E	G		
5014N70	70	94	96	60,5	80,5	96,4	65,5	12,0	1
5014N100	95	120	126	74	108	123	70,5	17,5	1

Flangiati tipo multi 5024

Flanged multi type 5024

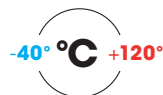
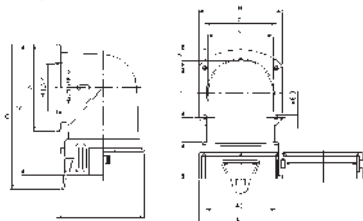

UL 1696 CSA22.2
File n.E86359



Codici di riferimento
MULTI-WFP IP54

Reference code
MULTI-WFP IP54

CODICE IP54 IP54 CODE	DIMENSIONI, mm DIMENSIONS, mm										kg/100pz	CONFEZIONE PACKAGE pz pcs
	DN ϕ	ϕ A	ϕ B	C	D	ϕ E	G	K	L	N		
5024N70	70	94	96	60,5	80,5	96,4	70	105	109	73	17,1	1
5024N100	95	120	126	74	108	123	95	130	142	98,2	37,0	1

Guarnizione per raccordi flangiati tipo multi 5014K

Seal for flanged fittings multi type 5014K

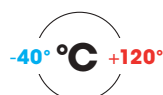

Codici di riferimento
MULTI-FRM IP54

Reference code
MULTI-FRM IP54

CODICE IP65 IP65 CODE	CONFEZIONE PACKAGE	
	DN ϕ	pz pcs
5014K70	70	1
5014K100	95	1

CODICE IP68/69K IP68/69K CODE	CONFEZIONE PACKAGE	
	DN ϕ	pz pcs
5014K7068	70	1
5014K10068	95	1

Raccordi in poliammide

Polyamide fittings

Monopezzo

One-piece

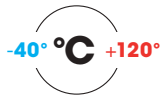

UL 1696 CSA22.2
File n.E86359



Semplicità di montaggio, resistenza alle vibrazioni ed allo strappo, dimensioni contenute per installazione ravvicinata, accoppiamento con i tubi flessibili e prodotti a norme DIN. Autoestinguenti, privi di sostanze alogene, silicone e cadmio. Alta resistenza agli oli, benzine, acidi e solventi. Il collegamento raccordo-tubo si ottiene spingendo a fondo il tubo nel raccordo, la cui forma interna liscia e troncoconica, consente di ottenere un grado di tenuta IP66. Per il disinnesto è necessario l'utilizzo di un normale cacciavite.

Ease of installation, resistance to vibration and tear, compact size for easier close-range installation and coupling with conduit products according to DIN. Self-extinguishing, halogen, silicone and cadmium-free. High resistance to oils, petrol, acids and solvents. The connection fitting-conduit is obtained by pushing the pipe into the connector, whose inner shape smooth and truncated conical, allows to obtain a sealing degree IP66. For the disconnection of the coupling it is necessary to use an ordinary screwdriver.

Filettature

- Metrico ISO conforme CEI EN 60423
- PG secondo DIN 40430 a richiesta

Threads

- ISO metric compliant IEC EN 60423
- PG in accordance with DIN 40430

Colore

Nero

Colour

Black

Dritto 5012L

Straight 5012L



Codice di riferimento
RQLG1 IP65
Reference code
RQLG1 IP65

CODICE IP65 IP65 CODE	DIMENSIONI, mm DIMENSIONS, mm							CONFEZIONE PACKAGE pz pcs
	DN ø	ø F	ø l	ø B	C	D	CH	
5012L-0712N	10	M 12 x 1,5	7,0	17,0	11,0	34,5	16	100
5012L-1016N	13	M 16 x 1,5	10,0	20,0	11,0	37,0	18	100
5012L-1220N	15,8	M 20 x 1,5	12,5	24,0	11,0	39,0	22	100
5012L-1420N	18,5	M 20 x 1,5	14,0	26,0	13,0	40,0	27	100
5012L-1425N	18,5	M 25 x 1,5	14,0	26,0	13,0	40,0	27	100
5012L-1720N	21,2	M 20 x 1,5	14,0	29,5	13,0	45,5	27	100
5012L-1725N	21,2	M 25 x 1,5	14,0	29,5	13,0	45,5	27	100
5012L-2325N	28,5	M 25 x 1,5	18,8	36,0	13,0	49,0	35	50
5012L-2332N	28,5	M 32 x 1,5	18,8	36,0	13,0	49,0	35	50
5012L-2932N	34,5	M 32 x 1,5	26,0	44,0	15,0	54,0	43	50
5012L-2940N	34,5	M 40 x 1,5	26,0	44,0	15,0	54,0	43	50
5012L-3640N	42,5	M 40 x 1,5	35,0	52,0	16,0	61,0	53	25
5012L-3650N	42,5	M 50 x 1,5	35,0	52,0	16,0	61,0	53	25
5012L-4850N	54,5	M 50 x 1,5	45,0	64,0	16,0	68,0	66	25
5012L-4863N	54,5	M 63 x 1,5	45,0	64,0	16,0	68,0	66	25

Curvo a 90° 5029L

Elbow 90° 5029L



Codice di riferimento
RQLB1 IP65
Reference code
RQLB1 IP65

CODICE IP65 IP65 CODE	DIMENSIONI, mm DIMENSIONS, mm							CONFEZIONE PACKAGE pz pcs
	DN ø	ø F	ø l	ø B	C	D	CH	
5029L-1016N	13	M 16 x 1,5	10,0	20,0	11,0	47,0	18	50
5029L-1220N	15,8	M 20 x 1,5	12,5	24,0	11,0	52,0	22	50
5029L-1420N	18,5	M 20 x 1,5	14,0	26,0	13,0	55,5	27	50
5029L-1425N	18,5	M 25 x 1,5	14,0	26,0	13,0	55,5	27	50
5029L-1720N	21,2	M 20 x 1,5	14,0	29,5	13,0	54,2	27	50
5029L-1725N	21,2	M 25 x 1,5	14,0	29,5	13,0	54,2	27	50
5029L-2325N	28,5	M 25 x 1,5	18,8	36,0	13,0	66,7	35	25
5029L-2332N	28,5	M 32 x 1,5	18,8	36,0	13,0	66,7	35	25
5029L-2932N	34,5	M 32 x 1,5	26,0	44,0	15,0	71,0	43	10
5029L-2940N	34,5	M 40 x 1,5	26,0	44,0	15,0	71,0	43	10
5029L-3640N	42,5	M 40 x 1,5	35,0	52,0	16,0	81,5	53	10
5029L-3650N	42,5	M 50 x 1,5	35,0	52,0	16,0	81,5	53	10
5029L-4850N	54,5	M 50 x 1,5	45,0	64,0	16,0	94,8	66	5
5029L-4863N	54,5	M 63 x 1,5	45,0	64,0	16,0	94,8	66	5

■ Raccordi in poliammide Polyamide fittings

Passaparete 5052 Panel mount 5052

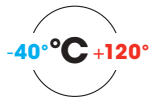
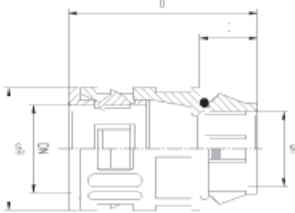

EN/IEC 61386-23



La particolare conformazione del terminale consente un rapido aggancio in fori praticati su pareti dello spessore da 1 a 2,5 mm senza l'utilizzo di controdado. La tenuta IP66 dell'accoppiamento è assicurata da una guarnizione O-Ring alloggiata nel raccordo.

The particular shape of the terminal permits a quick coupling in the holes made on the walls of thickness 1 to 2.5 mm without using a lock nut. The IP66 sealing of the coupling is ensured by an O-ring housed in the connector.

Colore
Nero

Colour
Black

Codici di riferimento
RQG1-S IP66

Reference code
RQG1-S IP66

CODICE IP68/IP69K IP68/IP69K CODE	RIF: FORO			DIMENSIONI, mm DIMENSIONS, mm						CONFEZIONE PACKAGE	
	DN ø	M	PG	ø	ø l	ø B	C	D	CH	kg/100pz	pz. / pcs
5052-07N	10	-	7	12	7	17	17,7	34,5	16	0,44	50
5052-1012N	13	M 12 x 1,5	-	12	9	20	12	37	18	0,60	50
5052-10N	13	-	9	15	10	20	13,6	38,6	18	0,60	50
5052-1216N	15,8	M 16 x 1,5	-	16	11,8	23	13,5	40,5	21	0,70	50
5052-12N	15,8	-	11	18	12,5	23	13,5	40,5	21	0,76	50
5052-1720N	21,2	M 20 x 1,5	-	20	15,2	29,5	13,8	45,3	27	1,10	50
5052-17N	21,2	-	16	22	18	29,5	13,8	45,3	27	1,24	50
5052-23N	28,5	-	21	28	23,5	37	17,9	51,9	34	2,32	25
5052-2325N	28,5	M 25 x 1,5	-	25	21	37	17,5	51	34	1,92	25
5052-29N	34,5	-	29	37	30,5	44	18,7	54,7	40	2,48	25
5052-36N	42,5	-	36	47	36,5	52	21	60	49	2,70	25
5052-4850N	54,5	M 50 x 1,5	-	50	43	64	21	63	59	3,70	10

Passaparete 5031 Panel mount 5031

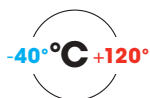
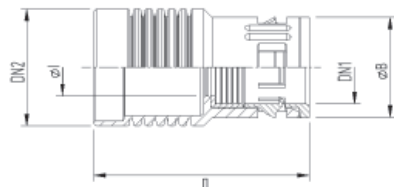

UL 1696 CSA22.2
File n.E86359



DIN 5510-2 (S1)



NF F 16-101/102
(I3/F2)



EN 45545-2

HL2



Raccordi di riduzione realizzati in poliammide PA 6.6, consentono di effettuare giunzioni tra tubi con diametri differenti, mantenendo il grado di tenuta IP68/IP69K.

Connectors reduction made of polyamide PA 6.6, make it possible to create joints between conduits with different diameters, while maintaining the degree of sealing IP68/IP69K.

Codici di riferimento
RQGR

Reference code
RQGR

CODICE IP68/69K IP68/69K CODE	DIMENSIONI, mm DIMENSIONS, mm		B	ø l	D	kg/100pz	CONFEZIONE PACKAGE pz pcs
	DN1 ø	DN2 ø					
5031-0717N	10	21,2	17	8	58	0,80	10
5031-0723N	10	28,5	17	7	63	1,40	10
5031-1012N	13	15,8	20	10	56	0,90	10
5031-1017N	13	21,2	20	10	60,5	0,90	10
5031-1217N	15,8	21,2	23	12,5	60,5	1,20	10
5031-1223N	15,8	28,5	23	12,5	63	1,60	10
5031-1229N	15,8	34,5	23	12,5	60	1,70	10
5031-1723N	21,2	28,5	29,5	17	65	2,14	10
5031-1729N	21,2	34,5	29,5	17	64	2,00	10
5031-1748N	21,2	54,5	29,5	17	86	4,00	5
5031-2329N	28,5	34,5	37	23,5	70	3,20	10
5031-2936N	34,5	42,5	44	30	75	3,80	10
5031-3648N	42,5	54,5	52	39	84	4,50	5

Raccordi in poliammide Polyamide fittings

Raccordi terminali e testacanna 5050 End cap and bushings 5050

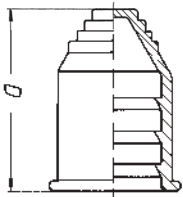

DN

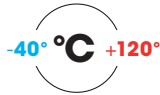

Sono prodotti in TPE ed il collegamento raccordo – tubo flessibile si ottiene semplicemente spingendo il tubo all'interno del raccordo.

La particolare conformazione interna del raccordo, incuneandosi tra le ondulazioni del tubo, provoca il bloccaggio dell'accoppiamento, mentre l'elasticità del materiale consente di ottenere una tenuta IP 65. Raccordo terminale pressacavo, presenta la parte anteriore a scalini per poter essere tagliata in corrispondenza dell'equivalente diametro del cavo su cui esercitare la tenuta stagna.

Manufactured in TPE. The connection fitting a flexible conduit is obtained by simply pushing the conduit into the fitting. The particular internal shape of the fitting, wedging itself between the undulations of the conduit, causes the locking of the coupling, while the elasticity of the material permits to obtain a sealing IP 65. Endcap gland, with front steps to be able to be cut in correspondence of the equivalent diameter of the cable on which exercise the water tightness.

Colore
Nero

Colour
Black

CODICE IP65 IP54 CODE	DN ø	DIMENSIONI, mm DIMENSIONS, mm		kg/100pz	CONFEZIONE PACKAGE pz pcs
		MIN Ø - MAX Ø	D		
5050-07N	10	1,0-8,0	28	0,16	50
5050-10N	13	1,0-10,0	28	0,22	50
5050-12N	15,8	4,0-12,0	26	0,32	50
5050-14N	18,5	4,0-13,0	37,5	0,52	50
5050-17N	21,2	6,0-16,5	37	0,56	50
5050-23N	28,5	6,0-23,0	40	0,80	25
5050-29N	34,5	6,0-29,0	44	0,96	25
5050-36N	42,5	10,0-37,0	46	1,48	25
5050-48N	54,5	10,0-47,0	53	2,30	10

Raccordi terminali e testacanna (V0 UL94) 5097 End cap and bushings (V0 UL94) 5097

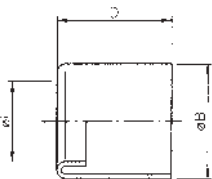

Sono prodotti in poliammide, autoestinguenti (UL 94:V0) e privi di alogeni. Questi accessori vengono applicati alle estremità dei tubi flessibili come soluzione tecnica ed a protezione del rivestimento dei cavi, quando l'impianto non prevede un grado di tenuta IP.

Made in polyamide, self-extinguishing (UL 94: V0) and halogen-free. These accessories are applied to the ends of the conduits as a technical solution and for the protection of the coating of the cables, when the system does not provide a degree of protection IP.

CODICE CODE	DN ø	ø I	DIMENSIONI, mm DIMENSIONS, mm		kg/100pz	CONFEZIONE PACKAGE pz pcs
			ø B	D		
5097-07N	10	4,3	12	20	0,10	50
5097-10N	13	7,8	15	20	0,14	50
5097-12N	15,8	10,3	17,8	20	0,16	50
5097-14N	18,5	12,1	20,5	21	0,24	50
5097-17N	21,2	14,3	23,2	21	0,22	50
5097-23N	28,5	20,8	30,5	22	0,32	25
5097-29N	34,5	26,8	36,5	22	0,40	25
5097-36N	42,5	33,8	44,5	25	0,64	25
5097-48N	54,5	45,8	56,5	25	0,80	10

Raccordi Fittings

Di distribuzione a "T" in poliammide 5033

Polyamide "T" distributor 5033

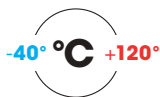
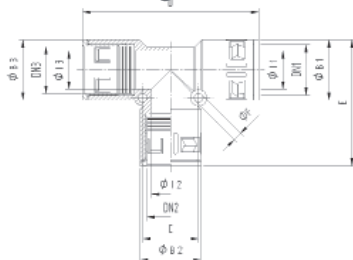

UL 1696 CSA22.2
File n.E86359



DIN 5510-2 (S1)



NF F 16-101/102
(I3/F2)



EN 45545-2

HL2



Raccordi di distribuzione realizzati in poliammide PA 6.6, consentono la realizzazione di derivazioni a T con la possibilità di avere i tubi derivati di diametro differente dal tubo principale, mantenendo il grado di tenuta IP68/IP69K.

Colore
Nero

Codice di riferimento
RQT-PA IP66/IP68/IP69K

Distribution fittings made of polyamide PA 6.6, allow the realization of T-branches, with the possibility of having the branch conduits of different diameters than the main conduit, while maintaining the IP68/IP69K degree of sealing.

Colour
Black

Reference code
RQT-PA IP66/IP68/IP69K

CODICE IP68/IP69K IP68/IP69K CODE	DIMENSIONI, mm DIMENSIONS, mm		CONFEZIONE PACKAGE		DIMENSIONI, mm DIMENSIONS, mm					
	DN2 ø	DN1/3 ø	B 2	B 1/3	E	D	ø F	C	kg/100pz	pz pcs
5033-121212NPA	15,8	2 x 15,8	23	23	54,5	80	2 x 5,5	20	2,20	10
5033-171717NPA	21,2	2 x 21,2	29,5	29,5	66	93,5	2 x 6,5	27	4,10	10
5033-232323NPA	28,5	2 x 28,5	37	37	78	107	2 x 6,5	34	5,90	10
5033-292929NPA	34,5	2 x 34,5	44	44	90,5	119	2 x 6,5	40	6,90	10
5033-292323NPA	34,5	2 x 28,5	44	37	77	113	2 x 6,5	38	8,10	10
5033-363636NPA	42,5	2 x 42,5	52	52	94,5	138	2 x 6,5	45	11,7	10
5033-484848NPA	54,5	2 x 54,5	64	64	105	146	2 x 6,5	56,5	16,4	5

Di distribuzione a "T" in TPE 5033

TPE "T" distributor 5033

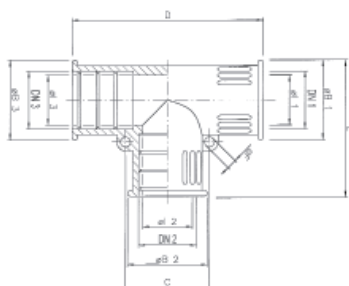

Sono prodotti in TPE ed il collegamento raccordo - tubo flessibile si ottiene semplicemente spingendo il tubo all'interno del raccordo.

La particolare conformazione interna del raccordo, incuneandosi tra le ondulazioni del tubo, provoca il bloccaggio dell'accoppiamento mentre l'elasticità del materiale consente di ottenere una tenuta IP66. Questi raccordi permettono la realizzazione di derivazioni a T con la possibilità di avere i tubi derivati di diametro differente dal tubo principale.

Manufactured in TPE. The connection fitting - flexible conduit is obtained by simply pushing the conduit into the fitting. The particular internal shape of the fitting, wedging itself between the undulations of the conduit, causes the locking of the coupling, while the elasticity of the material permits to obtain an IP66 sealing.

These connectors allow the realization of T branches with the possibility of having the branch conduit of different diameters than the main conduit.

Colore
Nero

Codice di riferimento RQT

Colour
Black

Reference code RQT

CODICE IP66 IP66 CODE	DIMENSIONI, mm DIMENSIONS, mm		CONFEZIONE PACKAGE		DIMENSIONI, mm DIMENSIONS, mm					
	DN2 ø	DN1/3 ø	B 2	B 1/3	E	D	ø F	C	kg/100pz	pz pcs
5033-070707N	10	2 x 10,0	17,5	17,5	32,5	46,5	4	18,3	0,60	10
5033-101010N	13	2 x 13,0	21	21	36	51	4	21	0,90	10
5033-121212N	15,8	2 x 15,8	25	25	44	63	4	24,5	1,51	10
5033-141414N	18,5	2 x 18,5	26,5	26,5	48,5	70,5	4	24,3	2,90	10
5033-171717N	21,2	2 x 21,2	29,5	29,5	50	71	4	29,5	1,70	10
5033-231717N	28,5	2 x 21,2	36,5	32	51	78	4	29,5	2,00	10
5033-122323N	15,8	2 x 28,5	25,5	36,5	56	65	4	37	3,00	10
5033-232323N	28,5	2 x 28,5	36,5	36,5	57,5	77	4	37	2,90	10
5033-292929N	34,5	2 x 34,5	42,5	42,5	64	85	4	42	4,20	10

Raccordi Fittings

Di distribuzione a "Y" in poliammide 5025

Polyamide "Y" distributor 5025



UL 1696 CSA22.2
File n.E86359



DIN 5510-2 (S1)



NF F 16-101/102
(I3/F2)



EN 45545-2:2013
HL2



Raccordi di distribuzione realizzati in poliammide PA 6.6, consentono la realizzazione di derivazioni parallele con la possibilità di avere i tubi derivati di diametro differente dal tubo principale, mantenendo il grado di tenuta IP66/IP68/IP69K.

Colore
Nero

Codici di riferimento
RQY-PA

Distribution fittings made of polyamide PA 6.6, allow the realization of parallel branches with the possibility of having the branch conduits of different diameters from the main conduit, while maintaining the degree of sealing IP66/IP68/IP69K.

Colour
Black

Reference code
RQY-PA

CODICE IP68/IP69K IP68/IP69K CODE	DIMENSIONI, mm DIMENSIONS, mm		DIMENSIONI, mm DIMENSIONS, mm						CONFEZIONE PACKAGE	
	DN1 ø	DN2 ø	B1	B2	D	C	ø F	E	kg/100pz	pz pcs
5025-101013NPA	13	2 x 10,0	20	17	68	36	2 x 5,5	19	1,60	10
5025-131313NPA	13	2 x 13,0	20	20	70	42	2 x 5,5	20	1,80	10
5025-131316NPA	15,8	2 x 13,0	23	20	71	42	2 x 5,5	22	2,00	10
5025-161616NPA	15,8	2 x 15,8	23	23	80	48	2 x 5,5	23	2,20	10
5025-161621NPA	21,2	2 x 15,8	29,5	23	87,5	51	2 x 5,5	27	3,46	10
5025-212128NPA	28,5	2 x 21,2	37	29,5	99	62,5	2 x 6,5	37	5,50	10
5025-282834NPA	34,5	2 x 28,5	44	37	106	77,5	2 x 6,5	43	7,54	10
5025-343442NPA	42,5	2 x 34,5	52	44	125	98	2 x 6,5	45	12,0	10
5025-424254NPA	54,5	2 x 42,5	64	52	129,5	110	2 x 6,5	62	17,34	5

Di distribuzione a "Y" in TPE 5025

TPE "Y" distributor 5025

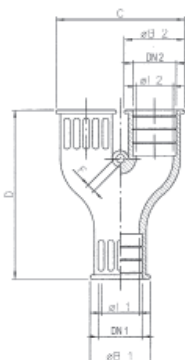

Prodotti in TPE, il collegamento raccordo - tubo flessibile si ottiene spingendo il tubo all'interno del raccordo.

La particolare conformazione interna del raccordo, incuneandosi tra le ondulazioni del tubo, provoca il bloccaggio dell'accoppiamento mentre l'elasticità del materiale consente di ottenere una tenuta IP66.

Colore
Nero

Codice di riferimento
RQY

Produced in TPE. The connection fitting - conduit is obtained by simply pushing the conduit into the fitting. The particular internal shape of the fitting, wedging itself between the undulations of the conduit, causes the locking of the coupling, while the elasticity of the material permits to obtain an IP66 sealing.

Colour
Black

Reference code
RQY

CODICE IP66 IP66 CODE	DIMENSIONI, mm DIMENSIONS, mm		DIMENSIONI, mm DIMENSIONS, mm						CONFEZIONE PACKAGE	
	DN1 ø	DN2 ø	B1	B2	D	C	ø F	E	kg/100pz	pz pcs
5025-101010N	10	2 x 10,0	17,5	17,5	54,5	36,5	1 x 4,0	19	0,63	10
5025-161621N	21,2	2 x 15,8	29,5	25	75	52	1 x 4,0	20	2,60	10
5025-161628N	28,5	2 x 15,8	36,5	25	75	52	1 x 4,0	22	2,80	10
5025-181818N	18,5	2 x 18,5	26,5	26,5	81	54,5	1 x 4,0	23	2,20	10
5025-212121N	21,2	2 x 21,2	29,5	29,5	82,5	62,5	1 x 4,0	27	2,90	10
5025-212128N	28,5	2 x 21,2	36,5	29,5	81,5	60,5	1 x 4,0	37	3,50	10
5025-282834N	34,5	2 x 28,5	42,5	36,5	86	77	1 x 4,0	43	5,20	10
5025-343442N	42,5	2 x 34,5	52,5	42,5	98,5	89	1 x 4,0	45	6,50	10
5025-424254N	54,5	2 x 42,5	65	52,5	116	109,5	1 x 4,0	62	11,6	5

Raccordi Fittings

Di giunzione in poliammide 5030 Polyamide junction 5030

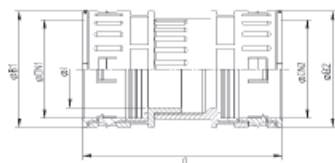

UL 1696 CSA22.2 File n.E86359	
DIN 5510-2 (S1)	
NF F 16-101/102 (I3/F2)	
EN 45545-2	

Raccordi di giunzione realizzati in poliammide PA 6.6, consentono la realizzazione di giunzioni tra tubi dello stesso diametro, mantenendo il grado di tenuta IP68/IP69K. Utilizzati anche per ridurre gli sprechi causati dagli spezzoni di tubo.

Colore
Nero

Codice di riferimento
RQK-PA IP66/IP68/IP69K

Junction fittings made of polyamide PA 6.6, allow the realization of coupling between conduits with the same diameter, maintaining the watertight IP68. Also used to reduce waste caused by conduit sections.

Colour
Black

Reference code
RQK-PA IP66/IP68/IP69K

CODICE IP68/IP69K IP68/IP69K CODE	DN1 ø	DN2 ø	B1	DIMENSIONI, mm DIMENSIONS, mm			kg/100pz	CONFEZIONE PACKAGE pz pcs
				B2	ø I	D		
5030-17NPA	21,2	21,2	29,5	29,5	17	82	2,60	10
5030-23NPA	28,5	28,5	37	37	23,5	90	3,50	10
5030-29NPA	34,5	34,5	44	44	30	96	4,70	10
5030-36NPA	42,5	42,5	63	58	36,5	138	11,2	10
5030-48NPA	54,5	54,5	74	68	45	167	19,9	10

Di giunzione in TPE 5030 TPE junction 5030

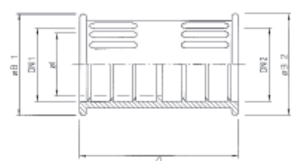

Sono prodotti in TPE ed il collegamento raccordo – tubo flessibile si ottiene spingendo il tubo all'interno del raccordo. La particolare conformazione interna del raccordo provoca il bloccaggio dell'accoppiamento mentre l'elasticità del materiale consente di ottenere una tenuta IP66. Questi raccordi permettono la realizzazione di giunzioni tra tubi dello stesso diametro. Utilizzati anche per ridurre gli sprechi causati dagli spezzoni di tubo.

Colore
Nero

Codice di riferimento
RQK

Manufactured in TPE and the connection fitting – flexible conduit is obtained by pushing the conduit into the fitting. The particular internal shape of the fitting, causes the locking of the coupling while the elasticity of the material allows to obtain a sealing IP66. These connectors allow the realization of coupling between conduits of the same diameter. Also used to reduce waste caused by conduit sections.

Colour
Black

Reference code
RQK

CODICE IP66 IP66 CODE	DN1 ø	DN2 ø	B1	DIMENSIONI, mm DIMENSIONS, mm			kg/100pz	CONFEZIONE PACKAGE pz pcs
				B2	D	D		
5030-07N	10	10	17,5	17,5	33,5	0,30	10	
5030-10N	13	13	20	20	36,5	0,37	10	
5030-12N	15,8	15,8	23	23	44,5	0,50	10	
5030-1312N	18,5	15,8	26,5	26,5	48	0,84	10	
5030-13N	18,5	18,5	26,5	26,5	48	0,80	10	
5030-17N	21,2	21,2	29,5	29,5	46	0,80	10	
5030-23N	28,5	28,5	36,5	36,5	46	1,10	10	
5030-29N	34,5	34,5	42,5	42,5	48	2,00	10	
5030-36N	42,5	42,5	51	51	60	4,00	10	
5030-48N	54,5	54,5	63	63	70	6,10	10	

Raccordi Fittings

Per tubi con taglio longitudinale **5012DUO** For conduit with longitudinal cut **5012DUO**



Accessori speciali composti da due parti richiudibili per l'impiego con i tubi dotati di apertura longitudinale, per l'installazione del sistema di protezione su impianti già cablati.
Filettatura Metrica ISO in conformità alle norme CEI EN 60423.

Special accessories composed of two re closable parts for use with conduit with a longitudinal opening, for the installation of the protection system on plants already wired.
Metric ISO thread in accordance with IEC EN 60423.

Codice di Riferimento
RQC-DUO-M IP50

Reference code
RQC-DUO-M IP50

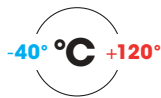
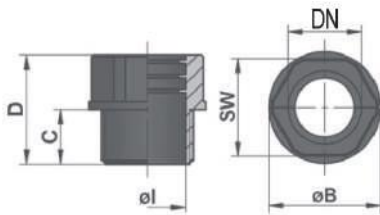

CODICE IP50 IP50 CODE	DIMENSIONI, mm DIMENSIONS, mm							kg/100pz	CONFEZIONE PACKAGE pz pcs
	DN ø	ø F	ø I	ø B	C	D	SW		
5012DUO-1216N	15,8	M 16 x 1,5	11	30	15	30	26	0,75	10
5012DUO-1220N	15,8	M 20 x 1,5	15	30	15	30	26	0,78	10
5012DUO-1720N	21,2	M 20 x 1,5	15	32	15	30	28	0,85	10
5012DUO-1725N	21,2	M 25 x 1,5	21	32	15	30	28	0,80	10
5012DUO-2325N	28,5	M 25 x 1,5	21	40	15	35	36	1,30	10
5012DUO-2332N	28,5	M 32 x 1,5	27	40	15	35	36	1,20	5
5012DUO-2932N	34,5	M 32 x 1,5	27	50	15	35	46	2,40	5
5012DUO-2940N	34,5	M 40 x 1,5	35	50	15	35	46	2,30	5
5012DUO-3640N	42,5	M 40 x 1,5	35	62	15	35	55	2,80	5
5012DUO-3650N	42,5	M 50 x 1,5	44	62	20	40	55	2,70	5
5012DUO-4850N	54,5	M 50 x 1,5	44	72	20	45	65	3,30	5
5012DUO-4863N	54,5	M 63 x 1,5	57	72	20	45	65	3,50	5

Controdado per tubi con taglio longitudinale **6006DUO** Counternut for conduits with longitudinal cut **6006DUO**

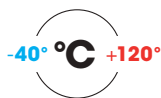

Codice di Riferimento
GMK-DUO-M

Reference code
GMK-DUO-M

CODICE IP50 IP50 CODE	ø F	DIMENSIONI, mm DIMENSIONS, mm		kg/100pz	CONFEZIONE PACKAGE pz pcs
		SW	C		
6006DUO-16N	M 16 x 1,5	26	10	0,16	10
6006DUO-20N	M 20 x 1,5	26	10	0,18	10
6006DUO-25N	M 25 x 1,5	28	10	0,20	10
6006DUO-32N	M 32 x 1,5	36	10	0,40	5
6006DUO-40N	M 40 x 1,5	46	12	0,90	5
6006DUO-50N	M 50 x 1,5	56	12	1,20	5
6006DUO-63N	M 63 x 1,5	71	12	1,85	5

■ Elementi di fissaggio Fasteners

Collare fissatubo monopezzo (V0 UL94) 5043 One-piece conduit clamp collar (V0 UL94) 5043

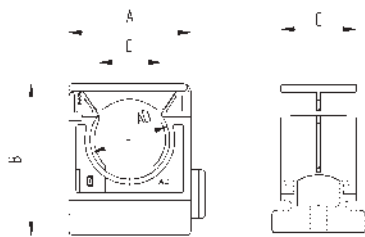

Elementi di fissaggio monopezzo realizzati in poliammide, sono caratterizzati da un'estrema facilità d'impiego in quanto l'ancoraggio avviene mediante un'unica vite centrale. Il coperchio è fissato alla base.

Per l'installazione è sufficiente premere il tubo nell'alloggiamento fino al bloccaggio, il coperchietto richiuso a scatto impedisce qualsiasi movimento del tubo.

E' possibile disporre i fissatubo in batteria mediante un incastro realizzato sui particolari oppure utilizzando un'apposita barra di fissaggio metallica.

Bassa emissione di fumi in caso di incendio che li rende particolarmente indicati per applicazioni nel settore ferroviario e in tutti i luoghi a maggior rischio di incendio.

One-Piece fastening elements made of polyamide, characterized by extreme ease of use, because the anchoring is done by a single central screw.

The cover is secured to the base.

For the installation, simply press the conduit into the housing until it locks.

The cover with snap-locking prevents any movement of the conduit.

It's possible to arrange the conduit clamp collars in array employing a restrained joint realized on the details or by using a suitable mounting metal bar.

Low fume emission in case of fire makes these conduits particularly suitable for applications in the railway sector and all places where there is a greater risk of fire.

■ Autoestinguenza
Non propagante la fiamma CEI EN 61386
V0 (UL94)

■ Self-extinguishing
No flame propagation IEC EN 61386
V0 (UL94)

Codice di Riferimento
RQS

Reference Code
RQS



RQS

EN/IEC 61386-23



CODICE CODE	DN ϕ	FORO HOLE ϕ	DIMENSIONI, mm DIMENSIONS, mm			kg/100pz	CONFEZIONE PACKAGE pz pcs
			A	B	E		
5043-07N	10	4,5	21,7	23,7	20	0,70	50
5043-10N	13	5,5	26	29	20	0,92	50
5043-12N	15,8	5,5	26	29	20	0,86	50
5043-14N	18,5	5,5	32,5	37	20	1,24	50
5043-17N	21,2	6,5	32,5	37	20	1,22	50
5043-23N	28,5	6,5	43,3	50,4	20	1,80	25
5043-29N	34,5	6,5	43,3	50,4	20	1,72	25
5043-36N	42,5	6,5	65	77	20	3,12	25
5043-48N	54,5	6,5	65	77	20	3,00	10

■ Elementi di fissaggio Fasteners

Collare fissatubo (V0 UL94) 5045C

Conduit clamp collar (V0 UL94) 5045C

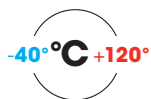
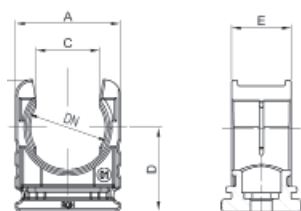

RQHG

EN/IEC 61386-23



Elementi di fissaggio realizzati in poliammide rinforzato, sono caratterizzati da un'estrema facilità d'impiego in quanto l'ancoraggio avviene mediante un'unica vite centrale.

Per l'installazione è sufficiente premere il tubo nell'alloggiamento fino al bloccaggio. Il coperchio con bloccaggio a scatto impedisce qualsiasi movimento del tubo.

E' possibile disporre i fissatubo in batteria mediante l'elemento di connessione cod.5047.

L' articolo 5045C è fornito completo di coperchio.

Colore
Nero

■ Autoestinguenza
Non propagante la fiamma CEI EN 61386
V0 (UL94)

Codice di Riferimento
RQHG

Fasteners made of reinforced polyamide, characterized by extreme ease of use, because the anchoring is done by a single central screw.

For the installation simply push the conduit into the slot until it locks.

The cover with snap locking prevents any movement of the conduit.

It is possible to arrange the conduit clamp collars in array by means of the connection element cod.5047.

Article 5045C is supplied complete with cover.

Colour
Black

■ Self-extinguishing
No flame propagation IEC EN 61386
V0 (UL94)

Reference code
RQHG

CODICE CODE	DN ø	FORO HOLE ø	DIMENSIONI, mm DIMENSIONS, mm					kg/100pz	CONFEZIONE PACKAGE pz pcs
			A	B	C	D	E		
5045C-07N	10	5,5	19,5	19	8,4	13	15	0,40	50
5045C-10N	13	5,5	19,5	22,6	9,3	14,5	15	0,42	50
5045C-12N	15,8	5,5	21,5	25,4	11,2	16,1	15	0,46	50
5045C-14N	18,5	5,5	24,5	29	12,6	18	15	0,58	50
5045C-17N	21,2	6,5	26,5	33	16,6	21	15	0,66	50
5045C-23N	28,5	6,5	34,7	39,4	20,4	22,7	15	0,92	25
5045C-29N	34,5	6,5	40	44,4	25,6	26	15	1,08	25
5045C-36N	42,5	6,5	54	55,5	30,1	30	20	2,36	25
5045C-48N	54,5	6,5	65	69	38,1	37,3	20	3,20	10

Elemento connessione collari fissatubo 5047

Connection for conduit clamp collar 5047



Codice di Riferimento
RQHV

Reference code
RQHV

CODICE CODE	Grigio Grey	DN ø	kg/100pz	CONFEZIONE PACKAGE pz pcs
5047N	5047G	10,0/54,5	0,03	100

■ Elementi di fissaggio Fasteners

Collare fissatubo monopezzo 5044

One-piece conduit clamp collars 5044



Elementi di fissaggio realizzati in acciaio zincato rivestito da un profilo in gomma a protezione della superficie del tubo, sono caratterizzati da un'estrema facilità d'impiego in quanto l'ancoraggio avviene mediante l'impiego di una sola vite.

Fasteners made of galvanized steel coated with a rubber profile to protect the surface of the conduit, characterized by extreme ease of use, as the anchoring is done by a single central screw.

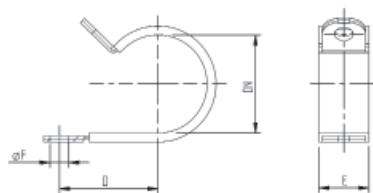

CODICE CODE			DIMENSIONI, mm DIMENSIONS, mm		CONFEZIONE PACKAGE
	DN ø	ø min	ø F	E	pz pcs
5044-07N	10	10	M5	12	100
5044-10N	13	12	M5	12	100
5044-12N	15,8	15	M5	12	100
5044-14N	18,5	18	M6	15	100
5044-17N	21,2	20	M6	15	50
5044-23N	28,5	25	M6	15	50
5044-29N	34,5	32	M8	20	25
5044-36N	42,5	40	M8	20	25
5044-48N	54,5	50	M8	20	25
5044-63N	-	65	M10	25	10

Elementi di fissaggio Fasteners

Collare fissatubo pesanti (V0 UL94) 5048

Heavy conduit clamp collar (V0 UL94) 5048

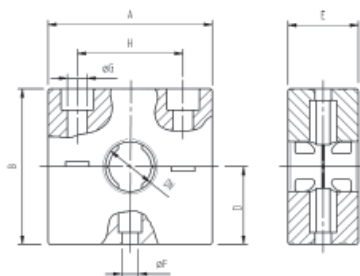

Sono realizzati in poliammide e composti da due elementi simmetrici che si uniscono per mezzo di due viti; l'ancoraggio avviene mediante un'unica vite centrale. Il serraggio del tubo è assicurato da una nervatura che si interpone tra le spire, impedendone qualsiasi movimento. E' possibile disporre i fissatubo in batteria, sia allineati che sovrapposti. Disponibili anche in versione multipla o con dimensioni ridotte.

Colore Nero

■ Autoestinguenza
Non propagante la fiamma CEI EN 61386
V0 (UL94)

Made of polyamide and consists of two geometrical elements that are joined by means of two screws; anchoring is done by a single central screw. The clamping of the conduit is ensured by a rib that is interposed between the turns, preventing any movement. It is possible to arrange the conduit clamp collars in the array, aligned or overlapping. Also available in multiple version or with reduced dimensions.

Colour Black

■ Self-extinguishing
No flame propagation IEC EN 61386
V0 (UL94)

1 tubo RQM 1 conduit RQM

CODICE CODE	DN ø	A	B	DIMENSIONI, mm DIMENSIONS, mm					kg/100pz	CONFEZIONE PACKAGE pz pcs
				D	E	ø F	ø G	H		
5048-17N	21,2	65	66	33	30	7	6,5	45	7,9	10
5048-23N	28,5	65	66	33	30	7	6,5	45	7,5	10
5048-29N	34,5	80	66	33	30	7	8,5	60	8,5	10
5048-36N	42,5	80	66	33	30	7	8,5	60	7,6	10
5048-48N	54,5	100	66	33	30	-	8,5	75	9,2	5

1 tubo dimensioni ridotte RQMS 1 small size conduit RQMS

CODICE CODE	DN ø	A	B	DIMENSIONI, mm DIMENSIONS, mm					kg/100pz	CONFEZIONE PACKAGE pz pcs
				D	E	ø F	ø G	H		
5048-12SN	15,8	50	33,5	16,5	30	7	6,5	34	3,1	10
5048-17SN	21,2	54	33,5	16,5	30	7	8,5	38	3,2	10
5048-23SN	28,5	60	40	20	30	7	8,5	44	3,8	10

2 tubi RQM2 2 conduits RQM2

CODICE CODE	DN ø	A	B	DIMENSIONI, mm DIMENSIONS, mm					kg/100pz	CONFEZIONE PACKAGE pz pcs
				D	E	ø F	ø G	H		
5048-362N	42,5	126	66	33	30	-	8,5	106	11	10

3 tubi RQM3 3 conduits RQM3

CODICE CODE	DN ø	A	B	DIMENSIONI, mm DIMENSIONS, mm					kg/100pz	CONFEZIONE PACKAGE pz pcs
				D	E	ø F	ø G	H		
5048-363N	42,5	172	66	33	30	-	8,5	152	14,3	10

Viti per batteria sovrapposta 5048V

Screws for overlapping battery 5048V

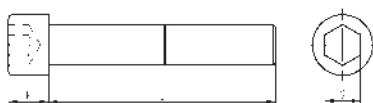

Le viti di serraggio sono da ordinare separatamente in base alla disposizione dei collari.

The clamping screws must be ordered separately according to the arrangement of the collars.

CODICE CODE	MATERIALE MATERIALS	F ø min	DIMENSIONI, mm DIMENSIONS, mm		CONFEZIONE PACKAGE pz pcs
			K	S	
5048V-1M6Z	Acciaio zincato Galvanized steel	M6	6	5	100
5048V-1M6X	Acciaio inox Stainless steel	M6	6	5	100
5048V-1M8Z	Acciaio zincato Galvanized steel	M6	8	6	100

■ Elementi di fissaggio Fasteners

Riduzioni 5048R

Reducers 5048R



Consentono di utilizzare i collari multipli (DN 42.5) con tubi di dimensioni inferiori. Ideali per il fissaggio di tubi pesanti o di grosse dimensioni. Le viti di serraggio sono da ordinare separatamente in base alla disposizione dei collari.

Allows you to use multiple collars (DN 42.5) with conduit of smaller dimensions. Ideal for fixing heavy or large dimensions conduits. The clamping screws must be ordered separately according to the arrangement of the collars.

Codice di riferimento RQMR

Reference code RQMR

CODICE CODE	DN1 ø	DN2 ø	kg/100pz	CONFEZIONE
				PACKAGE pz pcs
5048R-3612N	42,5	15,8	2,2	10
5048R-3617N	42,5	21,2	2,0	10
5048R-3623N	42,5	28,5	1,6	10
5048R-3629N	42,5	34,5	1,2	10

Collare antiabrasione 5049

Abrasion-resistant collar 5049

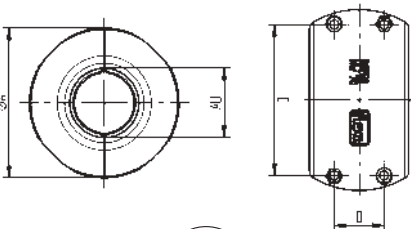

Realizzati in poliammide e composti da due elementi simmetrici che si uniscono per mezzo di due viti. Il serraggio sul tubo è assicurato da una nervatura che si interpone tra le spire. Particolarmente resistenti ad abrasione ed urti, vengono impiegati in installazioni sottoposte ad elevate sollecitazioni meccaniche o di strisciamento. Le viti in acciaio inox incluse nella confezione, sono a testa esagonale per consentire un maggior serraggio dell'accoppiamento.

Made of polyamide and composed of two symmetrical elements that are joined by means of two screws. The clamping of the conduit is ensured by a rib that is interposed between the coils. Particularly resistant to abrasion and shocks, are used in installations subjected to high mechanical stress or rolling. The stainless steel screws included in the package, are hexagonal head to allow a tighter coupling.

Codice di riferimento RQPRO

Reference code RQPRO

CODICE CODE	DN ø	ø A	B	DIMENSIONI, mm DIMENSIONS, mm		kg/100pz	CONFEZIONE
				C	ø F		PACKAGE pz pcs
5049-17N	21,2	45	22	31	5,5	2,36	25
5049-23N	28,5	52	26	39	5,5	2,88	25
5049-29N	34,5	58	26	45	5,5	3,40	10
5049-36N	42,5	66	30	54	5,5	4,20	10
5049-48N	54,5	77	30	65	5,5	5,00	5

Riduzioni per cavi 5048TPE

Reducers for cables 5048TPE

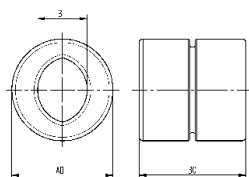

Accessorio da utilizzare in combinazione con il collare fissatubo cod. 5048 ed anti-abrasione cod. 5049.

Accessory to be used in combination with conduit clamp collar code 5048 and anti-abrasion code 5049.

Codice di Riferimento RQMR Kabel

Reference code RQMR Kabel

CODICE CODE	DN1 ø	SERRAGGIO CAVO	kg/100pz	CONFEZIONE
		CABLE TIGHTENING ø MIN - ø MAX		PACKAGE pz pcs
5048TPE-120710N	15,8	7 - 10	0,50	10
5048TPE-171014N	21,2	10 - 14	0,70	10
5048TPE-231418N	28,5	14 - 18	1,10	10
5048TPE-361822N	42,5	18 - 22	1,90	10
5048TPE-362226N	42,5	22 - 26	1,80	10
5048TPE-362630N	42,5	26 - 30	1,60	10
5048TPE-363034N	42,5	30 - 34	1,40	10
5048TPE-483438N	54,5	34 - 38	2,80	10
5048TPE-483842N	54,5	38 - 42	2,40	10
5048TPE-484246N	54,5	42 - 46	2,15	10

Raccordi pressacavo Gland fittings

Raccordi pressacavo filetto maschio plastico 5018 / 5018M Gland fittings plastic male thread 5018 / 5018M

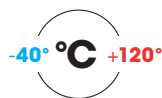
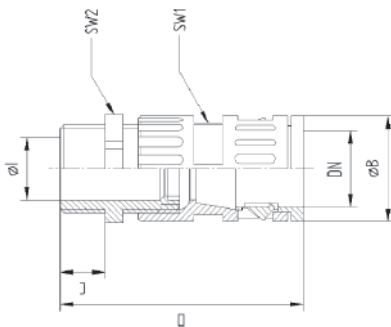

Sono composti da un corpo con terminale femmina al cui interno è alloggiato un gommino in TPE e da un elemento con filettature tipo maschio.

La compressione esercitata sul gommino durante l'avvitamento dei due componenti, provoca il serraggio del cavo e la relativa tenuta stagna, garantendo inoltre una notevole resistenza allo strappo. Le filettature proposte sono: Metrico ISO in conformità con le norme CEI EN 60423 e PG secondo DIN 40430.

■ Autoestinguenza UL94 V0

Colore Nero

Codice di Riferimento
RQGZ1 IP66

Composed of a body with a female terminal, inside of which there is a TPE rubber and an element with male type threads.

The compression applied to the gasket, while screwing the two components, causes the tightening of the cable and the relative tightness, also ensuring a remarkable tear strength.

The threads proposed are: ISO metric in compliance with IEC EN 60423 and PG in accordance with DIN 40430.

■ Self-extinguishing UL94 V0

Colour Black

Reference code
RQGZ1 IP66

UL 1696 CSA22.2 File n.E86359	
DIN 5510-2 (S1)	
EN/IEC 61386-23	
NF F 16-101/102 (I3/F2)	
EN 45545-2	HL2

Filettatura Metrica Metric thread

CODICE IP68/69K IP68/69K CODE	DIMENSIONI, mm DIMENSIONS, mm										CONFEZIONE PACKAGE pz pcs
	DN ø	MIN Ø - MAX Ø	F	Ø I	Ø B	C	D	CH1	CH2	kg/100pz	
5018M-0712N67	10	4 ÷ 6,5	M 12 x 1,5	6,5	17	8	51	16	15	0,8	20
5018M-1016N67	13	5 ÷ 9,5	M 16 x 1,5	9,5	20	8	53	18	20	1,3	20
5018M-1216N67	15,8	5 ÷ 9,5	M 16 x 1,5	10,5	23	8	60	21	20	1,5	20
5018M-1220N67	15,8	8 ÷ 11,0	M 20 x 1,5	13	23	8	59	21	24	1,5	20
5018M-1420N67	18,5	8 ÷ 11,0	M 20 x 1,5	12	27	8	59	24	24	1,7	20
5018M-1725N67	21,2	11 ÷ 16,0	M 25 x 1,5	16	33,5	8	70	27	29	3,0	10
5018M-2332N67	28,5	15 ÷ 21,0	M 32 x 1,5	18	37	11	82	34	36	3,8	10
5018M-2940N67	34,5	16 ÷ 26,0	M 40 x 1,5	25	44	10	85	40	46	5,7	10
5018M-3650N67	42,5	27 ÷ 35,0	M 50 x 1,5	32	58	12	141	55	55	11,2	10
5018M-4863N67	54,5	32 ÷ 42,0	M 63 x 1,5	44	68	12	145	65	68	13,2	10

Filettatura PG PG thread

CODICE IP68/69K IP68/69K CODE	DIMENSIONI, mm DIMENSIONS, mm										CONFEZIONE PACKAGE pz pcs
	DN ø	MIN Ø - MAX Ø	F	Ø I	Ø B	C	D	CH1	CH2	kg/100pz	
5018-0707N67	10	3 ÷ 6,5	7	7	17	8	51	16	15	0,80	20
5018-1009N67	13	4 ÷ 8,0	9	8	20	8	53	18	19	1,05	20
5018-1211N67	15,8	5 ÷ 10,0	11	10	23	8	59	21	22	1,45	20
5018-1213N67	15,8	6 ÷ 11,0	13,5	11	27	8	59	21	24	1,60	20
5018-1413N67	18,5	6 ÷ 12,0	13,5	12	27	8	59	24	24	1,60	20
5018-1713N67	21,2	6 ÷ 12,0	13,5	12	29,5	8	70	27	24	2,20	10
5018-1716N67	21,2	10 ÷ 14,0	16	14	29,5	10	72	27	27	2,30	10
5018-2321N67	28,5	13 ÷ 18,0	21	20	37	11	82	34	33	3,50	10
5018-2929N67	34,5	18 ÷ 25,0	29	25	44	12	85	40	42	5,00	10
5018-3636N67	42,5	22 ÷ 32,0	36	32	58	13	140	55	53	8,50	10
5018-4848N67	54,5	34 ÷ 44,0	48	44	68	14	144	65	65	11,2	10

Raccordi pressacavo Gland fittings

Filetto maschio metallico 5018M/M / 5018M/E Metallic male thread 5018M/M / 5018M/E

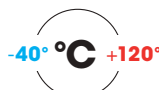
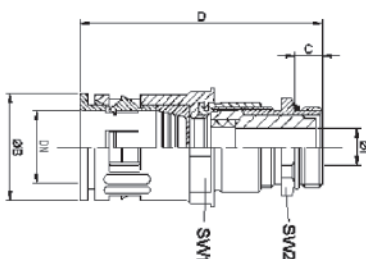

Sono composti da un corpo in poliammide e da un terminale in ottone nichelato che funge da pressacavo. La tenuta è garantita da una speciale guarnizione in TPE alloggiata internamente al corpo e dalla guarnizione in polipropilene e gomma applicata nel terminale pressacavo. Vengono normalmente utilizzati in impieghi gravosi in cui è richiesta una notevole resistenza alle sollecitazioni meccaniche.

Il Tipo M/E viene utilizzato in presenza di cavi schermati al fine di ottemperare le esigenze connesse alla compatibilità elettromagnetica. Le filettature proposte sono: Metrico ISO in conformità con le norme CEI EN 60423 e PG secondo DIN 40430. A richiesta sono disponibili con terminale PFLITSCH.

Composed of a polyamide body and a terminal nickel-plated brass which acts as a cable gland. The seal is guaranteed by a special TPE gasket housed internally to the body and by a gasket made of polypropylene and rubber applied in the terminal cable gland. They are normally used in heavy-duty applications where a considerable resistance to mechanical stresses is required.

The Type M/E is used in the presence of shielded cables to meet the requirements related to electromagnetic compatibility. The threads proposed are: ISO metric in compliance with IEC EN 60423 and PG in accordance with DIN 40430. Upon request are available with PFLITSCH terminal.

■ Autoestinguenza UL94 V0

■ Self-extinguishing UL94 V0

Codice di Riferimento
RQGKZP Tab. 1 - 2
RQGKZE Tab. 3 - 4

Reference Code
RQGKZP Tab. 1 - 2
RQGKZE Tab. 3 - 4

Filettatura Metrica Metric thread

CODICE IP68/IP69K IP68/IP69K CODE	SERRAGGIO TIGHTENING Ø Min. x Ø Max	DN DN Ø	Filetto	Ø I	DIMENSIONI DIMENSIONS				PESO WEIGHT		CONFEZIONE PACKAGE
					Ø B	C	D	CH1	CH2	Kg/100	pz
5018M-0712NM	3,0 ÷ 5,3	10	M 12 x 1,5	6,5	20	5	53,5	18	14	2,24	50
5018M-1016NM	5,0 ÷ 8,5	13	M 16 x 1,5	10	24	5	55	22	17	3,38	50
5018M-1220NM	7,5 ÷ 10,0	15,8	M 20 x 1,5	13,5	27	6	63	25	22	3,50	50
5018M-1720NM	10,0 ÷ 12,5	21,2	M 20 x 1,5	13,5	29,5	6	65	28	22	5,60	25
5018M-1725NM	9,0 ÷ 16,0	21,2	M 25 x 1,5	16,5	33	7	70	31	27	6,10	25
5018M-2325NM	11,0 ÷ 16,0	28,5	M 25 x 1,5	16,5	37	7	70	31	27	8,50	25
5018M-2332NM	12,0 ÷ 16,0	28,5	M 32 x 1,5	21	43	8	75	31	34	13,4	25
5018M-2932NM	14,5 ÷ 20,5	34,5	M 32 x 1,5	22	44	8	75	42	34	13,4	25
5018M-2940NM	19,0 ÷ 20,5	34,5	M 40 x 1,5	27,5	48	8	78	42	43	14,0	25
5018M-3640NM	21,0 ÷ 26,0	42,5	M 40 x 1,5	28	58	8	107	55	43	19,0	10
5018M-3650NM	20,0 ÷ 26,5	42,5	M 50 x 1,5	36	58	9	109	55	55	16,0	10
5018M-4850NM	25,0 ÷ 35,0	54,5	M 50 x 1,5	36	68	9	120	65	55	31,7	10
5018M-4863NM	32,0 ÷ 42,0	54,5	M 63 x 1,5	44	6	10	139	65	65	34,0	10

Filettatura PG PG thread

CODICE IP68/IP69K IP68/IP69K CODE	SERRAGGIO TIGHTENING Ø Min. x Ø Max	DN DN Ø	Filetto	Ø I	DIMENSIONI DIMENSIONS				PESO WEIGHT		CONFEZIONE PACKAGE
					Ø B	C	D	CH1	CH2	Kg/100	pz
5018M-0707NM	3,0 ÷ 6,0	10	7	6,8	20,5	5	50	18	14	2,74	50
5018M-1009NM	3,0 ÷ 8,0	13	9	8,5	24	6	56,5	22	17	2,60	50
5018M-1009NM	5,0 ÷ 10,0	15,8	11	10,5	27	6	57	25	20	3,50	50
5018M-1716NM	11,0 ÷ 14,0	21,2	16	14,8	33	6,5	65	31	24	5,12	25
5018M-2321NM	12,0 ÷ 18,0	28,5	21	18,5	41	7	71	39	30	8,48	25
5018M-2929NM	19,0 ÷ 25,0	34,5	29	25,5	48,5	8	75	46	40	13,28	25
5018M-3636NM	25,0 ÷ 33,0	42,5	36	34,5	58	9	103	55	50	17,80	10
5018M-4848NM	35,0 ÷ 43,0	54,5	48	44	68	10	120	65	64	29,80	10

UL 1696 CSA22.2
File n.E86359



DIN 5510-2 (S1)



EN/IEC 61386-23



NF F 16-101/102
(I3/F2)



EN 45545-2:2013

HL2



■ Raccordi pressacavo Gland fittings

Filetto maschio metallico 5018M/M / 5018M/E

Metallic male thread 5018M/M / 5018M/E

Filettatura Metrica Metrical thread

CODICE IP68/IP69K IP68/IP69K CODE	SERRAGGIO TIGHTENING Ø Min.. x Ø Max	DN ND Ø	Filetto	DIMENSIONI DIMENSIONS						PESO WEIGHT Kg/100	CONFEZIONE PACKAGE pz
				Ø I	Ø B	C	D	CH1	CH2		
5018M-0712NE*	3,0 ÷ 6,0	10	M 12 x 1,5	6,5	20	5	53,5	18	14	1,80	50
5018M-1016NE*	5,5 ÷ 8,5	13	M 16 x 1,5	10	24	5	55	22	17	3,44	50
5018M-1220NE*	7,5 ÷ 12,0	15,8	M 20 x 1,5	13,5	27	6	63	25	22	3,50	50
5018M-1720NE*	9,5 ÷ 12,0	21,2	M 20 x 1,5	13,5	29,5	6	65	28	22	5,60	25
5018M-1725NE*	9,5 ÷ 16,0	21,2	M 25 x 1,5	16,5	33	7	70	31	27	6,10	25
5018M-2325NE*	9,5 ÷ 16,0	28,5	M 25 x 1,5	16,5	37	7	70	31	27	6,88	25
5018M-2932NE*	14,5 ÷ 20,5	34,5	M 32 x 1,5	22	44	8	75	42	34	13,4	25
5018M-3640NE*	20,0 ÷ 26,5	42,5	M 40 x 1,5	28	58	8	107	55	43	19,6	10
5018M-4850NE*	25,0 ÷ 34,0	54,5	M 50 x 1,5	36	68	9	120	65	55	27,5	10

*A richiesta / On request

Filettatura PG PG thread

CODICE IP68/IP69K IP68/IP69K CODE	SERRAGGIO TIGHTENING Ø Min.. x Ø Max	DN ND Ø	Filetto	DIMENSIONI DIMENSIONS						PESO WEIGHT Kg/100	CONFEZIONE PACKAGE pz
				Ø I	Ø B	C	D	CH1	CH2		
5018M-0707NE*	3,0 ÷ 6,0	10	7	6,8	20,5	5	50	18	14	1,86	50
5018M-1009NE*	3,0 ÷ 8,0	13	9	8,5	24	6	56,5	22	17	2,80	50
5018M-1211NE*	5,0 ÷ 10,0	15,8	11	10,5	27	6	57	25	20	3,50	50
5018M-1716NE*	11,0 ÷ 14,0	21,2	16	14,8	33	6,5	65	31	24	4,90	25
5018M-2321NE*	12,0 ÷ 18,0	28,5	21	18,5	41	7	71	39	30	8,50	25
5018M-2929NE*	19,0 ÷ 25,0	34,5	29	25,5	48,5	8	75	46	40	13,4	25
5018M-3636NE*	25,0 ÷ 33,0	42,5	36	34,5	58	9	103	55	50	17,8	10
5018M-4848NE*	35,0 ÷ 43,0	54,5	48	44	68	10	120	65	64	28,4	10

*A richiesta / On request

■ Pressacavo Cable gland

In poliammide (V2 UL94) **6018-P**

Made of polyamide (V2 UL92) **6018-P**

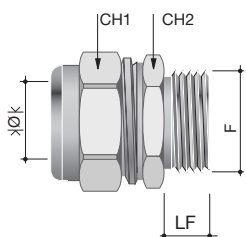

Prodotti in poliammide e costituiti da un corpo provvisto di lamelle elastiche che, sotto l'azione di un dado di serraggio, si chiudono concentricamente agendo in modo uniforme sul gommino di tenuta in NBR, garantendo una tenuta stagna IP68 ed un'efficace tenuta allo strappo.

La particolare forma trapezoidale della filettatura, assicura una efficace tenuta contro lo svitamento accidentale causato dalle vibrazioni.

Le guarnizioni sono resistenti all' invecchiamento, alla corrosione, agli oli e sono inerti nei confronti dei materiali che rivestono i cavi.

Colore

Grigio RAL 7001

- Resistenza al calore: prova filo incandescente a 750°C secondo VDE 0471 DIN e relativa norma internazionale IEC 695
- Grado di protezione del sistema **IP 68**
- Autoestinguenza **UL94 V2**

Made of polyamide, and constituted by a body fitted with elastic fins that, under the action of a tightening nut, tighten concentrically and uniformly around an NBR washer seal, ensuring an IP68 water tightness and remarkable tear strength.

The particular trapezoidal shape of the thread ensures an effective seal against accidental unscrewing through vibrations. The seals are resistant to ageing, corrosion and oils and remain inert to the material that sheaths the cables.

Colour

RAL 7001 Grey

- Resistance to heat: Glow wire tested to 750°C in accordance with VDE 0471 DIN and associated international IEC standard 695
- System protection degree **IP68**
- Self-extinguishing **UL94 V2**

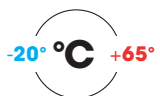

Filettatura Metrica Metric thread

CODICE CODE	SERRAGGIO CAVO CABLE TIGHTENING Ø Min.. x Ø Max	F	DIMENSIONI DIMENSIONS			CONFEZIONE PACKAGE pz
			CH1	CH2	LF	
6018-P12	3,5 ÷ 7	M12 x 1,5	15	15	8	50
6018-P16	4,5 ÷ 10	M16 x 1,5	20	20	8	50
6018-P20	6,0 ÷ 13	M20 x 1,5	24	24	9	50
6018-P25	9,0 ÷ 17	M25 x 1,5	29	29	10	50
6018-P32	15,0 ÷ 21	M32 x 1,5	36	36	11	20
6018-P40	16,0 ÷ 28	M40 x 1,5	44	44	11	5
6018-P50	27,0 ÷ 35	M50 x 1,5	54	54	12	5
6018-P63	34,0 ÷ 48	M63 x 1,5	68	68	12	5

Filettatura Metrica Metric thread

EN/IEC 61386-23



Filettatura PG PG thread

UL 1696 CSA22.2



Filettatura PG PG thread

CODICE CODE	SERRAGGIO CAVO CABLE TIGHTENING Ø Min.. x Ø Max	F	DIMENSIONI DIMENSIONS			CONFEZIONE PACKAGE pz
			CH1	CH2	LF	
6018-P07	3 ÷ 6,5	7	15	15	8	50
6018-P09	3,5 ÷ 8	9	19	19	8	50
6018-P11	4,5 ÷ 10	11	22	22	8	50
6018-P13	6 ÷ 12	13,5	24	24	9	50
6018-P15	7 ÷ 14	16	27	27	10	50
6018-P21	12 ÷ 18	21	33	33	11	50
6018-P29	17 ÷ 25	29	42	42	11	25
6018-P36	20 ÷ 32	36	53	53	13	10
6018-P42	26 ÷ 38	42	60	60	13	10
6018-P48	30 ÷ 44	48	65	65	14	5

■ Pressacavo Cable gland

In poliammide IP68 completo di controdado (V2 UL94) **6018-P-C** Made of polyamide IP68 complete with locknut (V2 UL94) **6018-P-C**

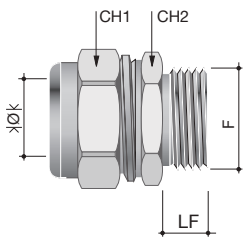

Prodotti in poliammide e costituiti da un corpo provvisto di lamelle elastiche che, sotto l'azione di un dado di serraggio, si chiudono concentricamente agendo in modo uniforme sul gommino di tenuta in NBR, garantendo una tenuta stagna IP68 ed un'efficace tenuta allo strappo. Il dado di serraggio presenta delle dentellature interne che, interferendo con le lamelle, rendono impossibile l'allentamento accidentale. Le guarnizioni sono resistenti all'invecchiamento, alla corrosione, agli oli e sono inerti nei confronti dei materiali che rivestono i cavi.

Colore
Grigio RAL 7035

- Resistenza al calore
Prova filo incandescente a 750°C secondo VDE 0471 DIN e IEC 695
- Grado di protezione **IP 68**
- Autoestinguenza UL94 **V2**

Made of polyamide, and constituted by a body fitted with elastic fins that, under the action of a tightening nut, tighten concentrically and uniformly around an NBR washer seal, ensuring an IP68 water tightness and remarkable tear strength. The lock nut has internal notches that obstruct the blades and make accidental unscrewing impossible. The seals are resistant to ageing, corrosion and oils and remain inert to the material that sheaths the cables.

Colour
Grey RAL 7035

- Resistance to heat
Glow wire tested to 750°C in accordance with VDE 0471 DIN and associated international IEC standard 695
- Protection rating **IP68**
- Self-extinguishing UL94 **V2**

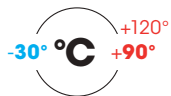

Filettatura Metrica Metric thread

CODICE CODE	SERRAGGIO CAVO CABLE TIGHTENING Ø Min.. x Ø Max	F	DIMENSIONI DIMENSIONS			CONFEZIONE PACKAGE pz
			CH1	CH2	LF	
6018-P16C	5 ÷ 10	M16 x 1,5	22	22	8,5	100
6018-P20C	6 ÷ 12	M20 x 1,5	24	24	10,0	100
6018-P25C	9 ÷ 14	M25 x 1,5	27	27	10,5	50
6018-P32C	15 ÷ 25	M32 x 1,5	42	42	11,5	25

Filettatura PG PG thread

CODICE CODE	SERRAGGIO CAVO CABLE TIGHTENING Ø Min.. x Ø Max	F	DIMENSIONI DIMENSIONS			CONFEZIONE PACKAGE pz
			CH1	CH2	LF	
6018-P09C	4 ÷ 8	9	19	19	8,5	200
6018-P11C	5 ÷ 10	11	22	22	8,5	100
6018-P13C	6 ÷ 12	13,5	24	24	10,0	100
6018-P15C	9 ÷ 14	16	27	27	10,5	50
6018-P21C	13 ÷ 18	21	33	33	11,5	50
6018-P29C	15 ÷ 25	29	42	42	11,5	25
6018-P36C	20 ÷ 31	36	51	51	16,0	15
6018-P42C	28 ÷ 38	42	63	63	16,5	10
6018-P48C	34 ÷ 43	48	66	66	16,5	5

Ghiere Ring nuts

In poliammide **6006**

In Polyamide **6006**

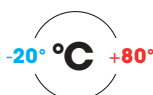
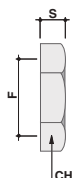

Sono prodotte in poliammide.
Le filettature proposte sono: Metrica ISO secondo le norme CEI EN 60423, GAS cilindrico UNI ISO 228 e PG secondo DIN 40430.

Made of polyamide.
The threads proposed are:
ISO metric according to the standards IEC EN 60423, cylindrical GAS UNI ISO 228 and PG according to DIN 40430.

Colore
Nero e Grigio

Colours
Black and Grey

Filettatura Metrica Metric thread

CODICE GRIGIO GREY CODE	CODICE NERO BLACK CODE	F	DIMENSIONI DIMENSIONS CH	S	CONFEZIONE PACKAGE pz
6006N-16B	6006N-16N	M16 x 1,5	24	5,0	100
6006N-20B	6006N-20N	M20 x 1,5	27	5,0	100
6006N-25B	6006N-25N	M25 x 1,5	33	6,0	50
6006N-32B	6006N-32N	M32 x 1,5	43	6,5	50
6006N-40B	6006N-40N	M40 x 1,5	50	7,5	25
6006N-50B	6006N-50N	M50 x 1,5	60	8,0	25
6006N-63B	6006N-63N	M63 x 1,5	70	9,0	50

Filettatura GAS ISO 228 GAS ISO 228 thread

CODICE GRIGIO GREY CODE	CODICE NERO BLACK CODE	F	DIMENSIONI DIMENSIONS CH	S	CONFEZIONE PACKAGE pz
6006N-14B	6006N-14N	1/4"	19	5,0	100
6006N-38B	6006N-38N	3/8"	24	5,0	100
6006N-12B	6006N-12N	1/2"	27	6,0	100
6006N-34B	6006N-34N	3/4"	33	6,5	50
6006N-01B	6006N-01N	1"	43	7,5	50
6006N-114B	6006N-114N	1" 1/4	50	8,0	25
6006N-112B	6006N-112N	1" 1/2	60	8,5	25
6006N-02B	6006N-02N	2"	70	9,0	25

Filettatura PG PG thread

CODICE GRIGIO GREY CODE	CODICE NERO BLACK CODE	F	DIMENSIONI DIMENSIONS CH	S	CONFEZIONE PACKAGE pz
6006-N07	6006-N07N	07	19	5,0	100
6006-N09	6006-N09N	09	24	5,0	100
6006-N11	6006-N11N	11	27	6,0	100
6006-N13	6006-N13N	13,5	27	6,0	100
6006-N15	6006-N15N	16	33	6,5	50
6006-N21	6006-N21N	21	43	7,5	50
6006-N29	6006-N29N	29	50	8,0	50
6006-N36	6006-N36N	36	60	8,5	25
6006-N42	6006-N42N	42	64	8,5	25
6006-N48	6006-N48N	48	70	9,0	25

■ Accessori Accessories

Anelli salvadita 5058

Finger protection rings 5058



Accessori in ottone nichelato, vengono utilizzati come soluzione tecnica nei tubi flessibili in poliammide protetti da treccia metallica. Sono costituiti da due semigusci cilindrici opportunamente sagomati al fine di inserirsi nell'ondulazione del tubo ed impedirne lo scorrimento assiale. Vengono collocati nella parte terminale del tubo sia come protezione dalle forature accidentali che per l'applicazione di una fascetta con vite di terra senza deformare il tubo.

Nickel plated brass accessories, are used as a technical solution in the polyamide conduits protected by metal braid. They consist of two cylindrical half-shells suitably shaped in order to fit inside the corrugation of the conduit and prevent it from sliding axially. They are placed in the end part of the conduit as protection from accidental drilling and for the application of a clamp with grounding screw without deforming the conduit.

CODICE CODE	DIAM. NOMINALE NOMINAL DIAM. ø, mm	CONFEZIONE PACKAGE pz
5058-07	10	25
5058-10	13	25
5058-12	15,8	25
5058-17	21,2	25
5058-23	28,5	25
5058-29	34,5	25
5058-36	42,5	25
5058-48	54,5	25

Cesoie tagliatubo S0433

Pipe-cutters S0433



Appositamente studiate per il taglio dei tubi flessibili plastici, queste robuste cesoie realizzano tagli netti e senza sbavature, requisiti fondamentali per il corretto assemblaggio tubo-raccordo e della tenuta stagna del sistema. Disponibili anche le lame di ricambio.

Specially designed for cutting plastic conduit, these sturdy shears realize clean cuts without burrs, the basic requirements for proper conduit-fitting assembly and for the water tightness of the system. Spare blades are also available.

Cesoie Pipe-cutter

CODICE CODE	DIAM. NOMINALE NOMINAL DIAM. ø, mm	CONFEZIONE PACKAGE pz
S0433000010	10 ÷ 34,5	1
S0433000011	21,2 ÷ 54,5	1

Lame di ricambio Spare blades

CODICE CODE	DIAM. NOMINALE NOMINAL DIAM. ø, mm	CONFEZIONE PACKAGE pz
S0433001010	10 ÷ 34,5	1
S0433001011	21,2 ÷ 54,5	1

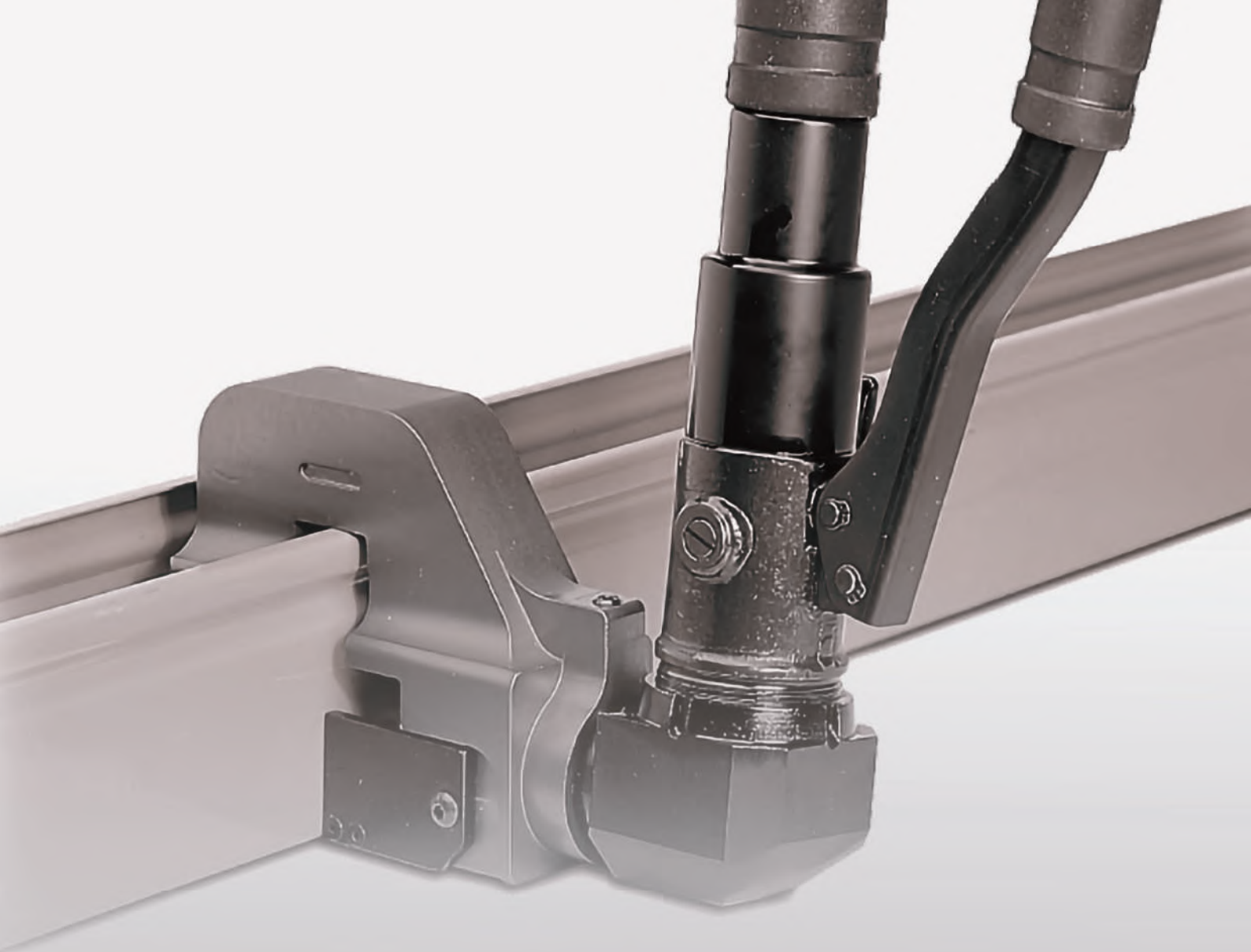

Attrezzature

Equipments

Foracanalé	Duct piercer	206
Tagliadin	Din cutter	208
Attrezzature	Equipments	210
Sistema di foratura	Drilling system	215
Banco di lavoro	Work bench	224
Accessori	Accessories	225

■ Foracanalè Duct piercer



Attrezzatura oleodinamica manuale idonea a forare senza preforo canali portacavi in metallo o in materiali plastici. Il movimento satellitare della testa perforatrice consente forature su canali installati a soli 16 cm dalla parete. È dotata di una valvola limitatrice di pressione, atta a salvaguardare l'attrezzo da eventuali utilizzi anomali. I materiali utilizzati per costruire la testa consentono di contenere il peso dell'attrezzatura in soli 3 kg.

È fornita in valigia con punzoni Ø16,2-20,4-25,5-32,5 mm, a richiesta è disponibile il punzone Ø40,5mm.
Spessore massimo: 1 mm (acciaio inox)
1,2 mm (Fe 370)

Hydraulic hand tool designed to punch cable ducts in metal or plastic materials, without pre-hole. The rotating motion of the punch head makes it possible to pierce ducts installed just 16 cm from the wall. It is equipped with a pressure relief valve designed to safeguard the equipment against improper use. The materials used in the construction of the head make it possible for the total weight of the tool to be just 3kg.

It is supplied in its own case, equipped with 16,2-20,4-25,5-32,5 mm Ø punches; a 40,5mm Ø punch is available on request. Maximum thickness: 1 mm (stainless steel)
1.2 mm (Fe 370)

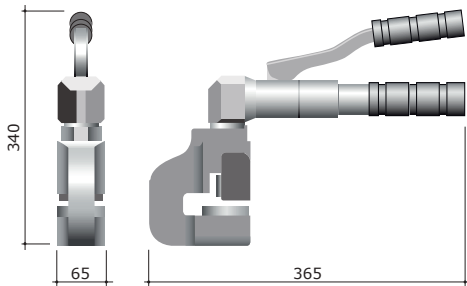

CODICE CODE	PUNZONI IN DOTAZIONE PUNCHES SUPPLIED	Kg	CONFEZIONE PACKAGE pz pcs
002250	M16, M20, M25, M32	3	1



■ Foracanalé Duct piercer

Testa foracanalé Duct piercer head

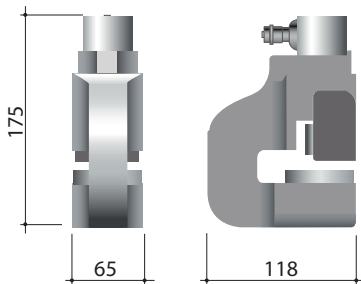

Attrezzatura idonea a forare senza preforo, canali portacavi in metallo o in materiali plastici. Deve essere azionata da una pompa idraulica, ha le stesse caratteristiche del foracanalé cod. 002250, con un ingombro e un peso considerevolmente ridotti. Fornita in valigia completa di punzoni tondi $\varnothing 16,2 - 20,4 - 25,5 - 32,5 - 40,5$ mm.

L'utilizzo di pompe oleodinamiche adibite ad altri impieghi, normalmente tarate a 70 MPa (700 bar), può sollecitare l'attrezzo ad uno sforzo vicino al carico di rottura. Deve essere quindi rigorosamente riservata una particolare attenzione agli spessori di foratura.

Spessore massimo: 1 mm (acciaio inox) 1,2 mm (Fe 370)

Pressione max d'esercizio: 45 MPa (450 bar)
Forza sviluppata: 27,7 kN

Equipment suitable for drilling cable ducts in metal or plastic material without pre-hole. It must be driven by a hydraulic pump and has the same features of the duct drill code 002250, but is significantly smaller in size and weight. Supplied in a carrying case, complete with the following round drill bits: 16.2 - 20.4 - 25.5 - 32.5 - 40.5 mm \varnothing .

The use of hydraulic pumps designed for other applications normally set at 70 MPa (700bar) may subject the equipment to a stress close to its breaking load.

Therefore special attention must be paid to hole thickness.

Maximum thickness: 1 mm (stainless steel) 1.2 mm (Fe 370)

Max working pressure: 45 MPa (450 bar)
Developed power: 27.7 kN

CODICE CODE	PUNZONI IN DOTAZIONE PUNCHES SUPPLIED	Kg	CONFEZIONE
			PACKAGE
			pz pcs
002251	M16, M20, M25, M32, M40	1,9	1

Punzoni tondi per foracanalé Round punches for duct piercer



CODICE MASCHIO MALE CODE	CODICE FEMMINA FEMALE CODE	DIAMETRO FORO
		HOLE DIAMETER
		\varnothing mm
0022M162	0022F162	16,2
0022M204	0022F204	20,4
0022M255	0022F255	25,5
0022M325	0022F325	32,5
0022M405	0022F405	40,5

■ Tagliadin Din cutter

Tagliadin Din cutter



Attrezzatura manuale idonea a tagliare e forare profili portanti a norme CEI EN 60715. Assicura un taglio netto senza deformazioni e permette di eseguire un foro tondo $\varnothing 6,5$ mm su tutta la mezziera dei profili.

Configurabile secondo le esigenze con lame ed accessori da acquistare separatamente, il Tagliadin è fornito privo di lame e completo di fermobarra standard lungo 1000 mm con possibilità di utilizzare moduli di prolunga da 600 mm.

Possibilità di sostituire le lame usurate e di integrare successivamente la dotazione con lame per altri profili ed accessori.

Per migliorare l'ortogonalità del taglio è consigliabile l'utilizzo degli appositi accessori come il supporto centratore ed i centratori di sagoma adeguati, entrambi da acquistare abbinati come da schema raffigurato in tabella.

L'attrezzatura manuale deve essere fissata su di un banco oppure sul supporto mobile cod. 001103-P, posizionabile di volta in volta vicino al posto di lavoro. Sulla base del supporto è fissata una cassetta atta a contenere gli eventuali accessori e le dotazioni di chiavi a corredo.

È previsto anche un kit oleodinamico cod. 001103-I, composto da un cilindro azionabile da una pompa o centralina idraulica.

Manual tool suitable for cutting and drilling bearing profiles complying with the standards IEC EN 60715. Ensures a clean cut without deformations and allows you to perform a round hole $\varnothing 6.5$ mm across the centreline of the profiles.

Configurable according to the needs with blades and accessories available separately, the Din cutter is supplied without blades and complete with standard bar holder 1000 mm long with the possibility of using 600 mm extension modules.

Possibility of replacing the worn blades and then integrate the supply with blades for other profiles and accessories.

To improve the squareness of cut, it is recommended to use special accessories such as appropriate centring support and mould guides, to be bought combined as in the diagram shown in the table.

The manual equipment must be fixed on a bench or on the mobile support cod.

001103-P, positionable close to the workplace. On the basis of the support there is a box containing the accessories and the spanners.

There is also a hydraulic kit cod. 001103-I, consisting of a cylinder which can be actuated by a pump or by a hydraulic controller.

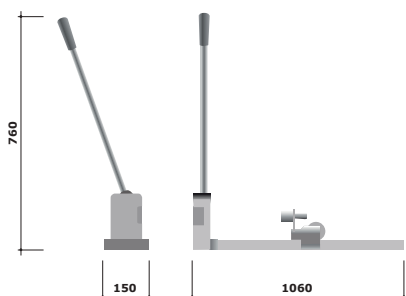

- Pressione max di esercizio **70Mpa**
- Forza sviluppata **40kN**
- Peso **0,69Kg**
- Massa totale **5,3 kg**

- Max working pressure **70Mpa**
- Developed power **40kN**
- Weight **0,69Kg**
- Total weight **5,3 kg**



CODICE CODE	DESCRIZIONE DESCRIPTION	CODICE ACCESSORI CODE ACCESSORIES	DESCRIZIONE ACCESSORI DESCRIPTION ACCESSORIES
001103-1	Tagliadin con fermobarra - struttura Din cutter with bar holder - structure	-	-
001103-A	Coppia lame G Blades G	001103-A1	Centratore sagoma G Mould guides C
001103-B	Coppia lame Omega bassa Blades Omega low	001103-S	Supporto centratore Centring device support
001103-C	Coppia lame Omega alta Blades Omega high	001103-BC1	Centratore sagoma omega Omega mould guide
001103-D	Coppia lame Omega ridotta Blades Omega reduced	001103-S	Supporto centratore Centring device support
001103-E	Coppia lame Omega alta e bassa Blades Omega high and low	001103-BC1	Centratore sagoma omega Omega mould guide
001103-F	Kit prolunga fermo barra 600 mm Bar holder extension kit 600 mm	001103-S	Supporto centratore Centring device support
001103-P	Supporto tagliadin Din cutter support	001103-E1	Centratore sagoma omega alta e bassa Omega high and low mould guide
001103-I	Kit oleodinamico Hydraulic kit	-	-

* Utilizzabile con struttura tagliadin con predisposizione foro laterale a partire da matricola 14050580
* Usable with din cutter structure with hole side predisposition starting from serial number 14050580

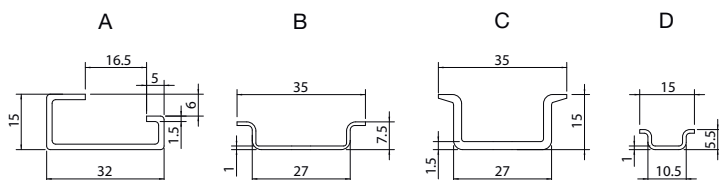

CEI EN 60715

■ Tagliadin Din cutter

Con lama doppio profilo omega fermobarra e centratore **001103-1BC** With double profile blade omega bar holder and guide **001103-1BC**



La versione cod. 001103-1BC è fornita completa di coppia lame a doppio profilo Omega (omega alta ed omega ridotta), supporto centratore per migliorare l'ortogonalità del taglio e fermobarra standard lungo 1000 mm, con possibilità di utilizzare moduli di prolunga da 600 mm.

The version cod. 001103-1BC is supplied complete with two double profile Omega blades (high omega and reduced omega), centring support to improve the squareness of the cut and standard bar holder 1000 mm long, with the possibility of using 600mm extension modules.

CODICE
CODE

DESCRIZIONE
DESCRIPTION

001103-1BC

Tagliadin con fermo barra, coppia lame Omega alta e bassa, centratore sagoma omega
Din cutter with bar holder, two blades Omega high and low, mould centring omega



Sistema Innovativo - una matrice, due lame Innovative system - one matrix - two blades

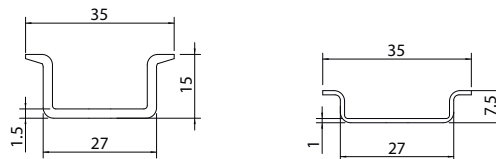

CEI EN 60715

■ Attrezzature Equipments

Pompa a pedale Foot pump

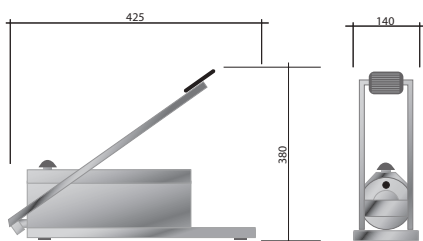

Pompa nata dalla lunga esperienza della Linea Cosmec nel campo oleodinamico, di assoluta affidabilità, costruita tenendo in considerazione gli ambienti in cui verrà ad operare.

Non necessita di alcuna manutenzione periodica. Dispone di due velocità di mandata: una di avvicinamento e una di lavoro. E' in grado di sviluppare una pressione di 70 MPa (700 bar), agendo con il minimo sforzo sulla leva a pedale. È dotata di valvola a scatto che, raggiunta la pressione di lavoro, la porta a zero per consentire lo scarico dei cilindri. La funzione di questa valvola è molto importante nell'uso dei cilindri aggraffatori perchè assicura la perfetta esecuzione del lavoro, garantendo l'uniformità del serraggio.

Fornita in cassetta adatta ad ospitare cilindri, stampi necessari e completa di tubo per alta pressione lungo 2m con innesto rapido femmina CEJN da 1/4".

Olio idraulico rispondente alle specifiche ISO-L-FC (Viscosità 2,7 mm²/sec a 100°).

Pump born from the long experience of Linea Cosmec in the hydraulic field. Absolutely reliable, manufactured taking into consideration the environments where it will have to operate.

Does not require any periodic maintenance. With two delivery speeds: one for approaching and one for working. It is capable of developing a pressure of 70 MPa (700 bar) by acting with minimum effort on the pedal lever. It is equipped with a toggle valve that, once the working pressure is reached, takes it back to zero, thus allowing the cylinders to drain.

The function of this valve is very important in the use of the seamer cylinders, as it ensures a perfect execution of the work, guaranteeing uniformity of the tightening. Supplied in a box able to accommodate cylinders necessary moulds, and equipped with a high-pressure 2m long pipe with Cejn 1/4" female quick-action coupling. Hydraulic oil that meets the ISO-L-FC specification (viscosity 2.7 mm²/sec to 100°).

CODICE CODE	DESCRIZIONE DESCRIPTION	PRESSIONE PRESSURE MPa / bar	FORZA MAX WEIGHT kN	SERBATOIO TANK L	MASSA TOTALE TOTAL WEIGHT Kg
00PA2002-C	Pompa a pedale Foot pump	70 (700bar)	55	0,5	3

Pompa pneumoidraulica Pneumhydraulic pump

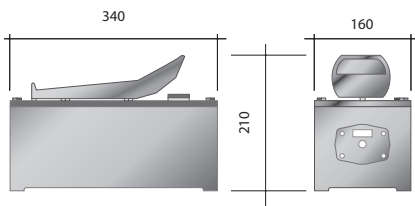

Attrezzatura da officina, utilizzabile solo con aria compressa. Questa pompa è in grado di sviluppare una pressione cento volte superiore alla pressione dell'aria utilizzata, con un massimo di 70 MPa (700 bar) regolata da una valvola di massima. Ad una sola velocità, costruita in materiale plastico salvo per la parte oleodinamica che è in acciaio di qualità.

Fornita con tubo per alta pressione lungo 2 m corredato da innesto rapido femmina CEJN da 1/4".

Olio idraulico rispondente alle specifiche ISO-L-FC (Viscosità 2,7 mm²/sec a 100°)

Workshop equipment, which can only be used with compressed air. This pump develops a pressure one hundred times greater than the pressure than the air used, with a maximum of 70 MPa (700 bar) regulated by a relief valve.

Single-speed, made in plastic material except for the hydraulic part that is made in quality steel.

Supplied with a high pressure 2m long tube accompanied by female quick coupling CEJN 1/4".

Hydraulic oil that meets the ISO-L-FC specification (viscosity 2.7 mm²/sec to 100°)

CODICE CODE	PRESSIONE PRESSURE MPa / bar	PORTATA FLOW RATE 70MPa l/min	PORTATA MIN MIN FLOW RATE l/min	INGRESSO ARIA MIN AIR INLET MIN bar	SERBATOIO TANK L	MASSA TOTALE TOTAL WEIGHT Kg
00PA2004	70 (700bar)	0,16 l/min	340	5,8	2,5	8,2

■ Attrezzature Equipments

Centralina elettroidraulica Electro hydraulic unit

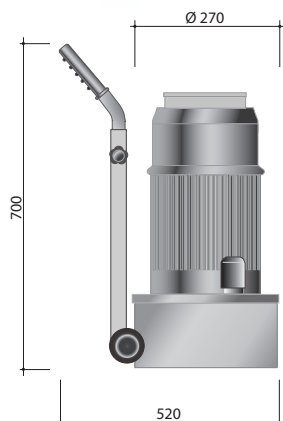

Apparecchiatura impiegata per azionare in modo rapido tutti gli attrezzi della Linea Cosmec. Munita di pressostato regolabile prearato che, a lavoro avvenuto, arresta il motore consentendo l'immediata apertura degli utensili. L'elevato numero di esemplari prodotti e la tecnologia impiegata, ne attestano l'assoluta affidabilità anche per lavori particolarmente gravosi. Fornita completa di tubo per alta pressione lungo 2 m con innesto rapido femmina CEJN da 1/4".

Olio idraulico rispondente alle specifiche ISO-L-FC (Viscosità 2,7 mm²/sec a 100°)

- Motore elettrico monofase **220V-50Hz**
- Assorbimento **0,75 kW**
- Pressione di esercizio **55 MPa (550 bar)**
- Pressostato regolabile prearato
- Dispositivo a 24V per comandi
- Maniglia telescopica
- Pedaliera antinfortunistica
- Portata **0,9 l/min**
- Capacità serbatoio **3 l**
- Predisposta per la connessione del controllo di foratura e piegatura per PFB 009012
- Munita di ruote per agevolare gli spostamenti
- Massa Totale **37 Kg**

Equipment used to operate quickly all Cosmec line tools. Equipped with pre-calibrated adjustable pressure switch that stops the motor at the end of the process enabling the immediate opening of the tools. The large number of pieces produced and the technology employed, attest its absolute reliability even for particularly heavy works. Supplied with high pressure 2m long pipe with Cejn 1/4" female quick-action coupling.

Hydraulic oil that meets the ISO-L-FC specification (viscosity 2.7 mm²/sec to 100°)

- Single-phase electric motor **220V-50Hz**
- Power absorption **0,75 kW**
- Operating pressure **55 MPa (550 bar)**
- Adjustable pre-calibrated pressure switch
- 24V control device
- Telescopic handle
- Safety pedals
- Flow rate **0,9 l/min**
- Tank capacity **3 l**
- Designed to connect with the punching and bending control PFB 009012
- Equipped with wheels in order to facilitate the movements
- Total weight **37 Kg**

CODICE
CODE

DESCRIZIONE
DESCRIPTION

00HP1550

Centralina elettroidraulica completa di tubo
Electro hydraulic controller with pipe



Facilmente movimentabile
Le centraline sono provviste di carrello per facilitare la movimentazione.
Easily movable
The controllers are provided with a trolley to facilitate handling.



Curata nei particolari
Dotata di pressostato regolabile prearato che arresta il motore consentendo l'immediata apertura degli utensili.
With special attention to details
Equipped with pre-calibrated adjustable pressure switch that stops the motor enabling the immediate opening of the tools.



Protetta nei trasporti
Le casse in legno fumigate proteggono le centraline durante il trasporto.
Protected during transport
The fumigated wooden crates protect the controllers during transport.

■ Attrezzature Equipments

Punzonatrice oleodinamica Hydraulic punching machine

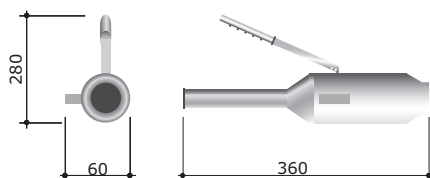

Attrezzatura portatile ideale per la foratura di pannelli in lamiera Fe 370, inox, materiali plastici e cassette in lega di alluminio. Utilizza i punzoni tradizionali a trazione e quindi necessita di un preforo per il passaggio dei perni. E' fornita in una comoda valigia. Punzoni ed accessori sono da richiedere separatamente.
Pressione MAX di esercizio: 70MPa (700 bar)
Forza sviluppata: 55 kN

Portable equipment ideal for punching panels sheet Fe 370, stainless steel, plastic materials and aluminium alloy boxes. It uses traction-powered traditional punches and therefore requires a pre-hole for the passage of the pins. It is supplied in a convenient case. Punches and accessories must be ordered separately.
MAX working pressure: 70MPa (700 bar)
Developed power: 55 kN

Capacita' di Foratura

- Foro tondo fino a Ø72mm
(Ø 48 mm con fustelle per inox)
- Foro quadro fino a 68x68mm
- Foro rettangolare fino a 46x92mm

Punching capacity

- Round hole up to Ø72mm
(Ø 48 mm with punches for stainless steel)
- Square hole up to 68x68mm
- Rectangular hole up to 46x92mm

Spessori

- 2 mm Acciaio INOX AISI 304
- 2,5 mm Fe 370
- 5 mm Alluminio e Materiali plastici

Thickness

- 2 mm Stainless Steel AISI 304
- 2,5 mm Fe 370
- 5 mm Aluminium and Plastic Materials

CODICE CODE	DESCRIZIONE DESCRIPTION	PESO WEIGHT Kg	QUANTITÀ QUANTITY
002452C	Punzonatrice oleodinamica in valigia Hydraulic punching machine in a case	2,6	1

Materiale per punzonare PG Punching Material PG



CODICE CODE	DESCRIZIONE DESCRIPTION	DIAMETRO DIAMETER ø mm	QUANTITÀ QUANTITY
002455N	KIT COMPLETO PG COMPLETE KIT PG		1
Composizione KIT Composition KIT			
002452N	Punzonatrice oleodinamica Hydraulic punching machine		1
00PT11	Perno tondo 11 mm Round Pin 11 mm		1
00PT16	Perno tondo 16 mm Round Pin 16 mm		1
003122	Fustella tonda 15,5 mm Round punch 15.5 mm	PG9	1
003002	Fustella tonda 19,5 mm Round punch 19.5 mm	PG11	1
003003	Fustella tonda 21 mm Round punch 21 mm	PG13,5	1
003004	Fustella tonda 22,5 mm Round punch 22.5 mm	PG16	1
003008	Fustella tonda 28,5 mm Round punch 28.5 mm	PG21	1
003110	Fustella tonda 37 mm Round punch 37 mm	PG29	1
003017	Fustella tonda 48 mm Round punch 48 mm	PG36	1
004104P	Valigia Case		1

■ Attrezzature Equipments

Punzonatrice oleodinamica Hydraulic punching machine



Materiale per punzonare GAS ISO 228 Punching Material GAS ISO 228

CODICE CODE	DESCRIZIONE DESCRIPTION	DIAMETRO DIAMETER ø mm	QUANTITÀ QUANTITY
002456N	KIT COMPLETO GAS ISO 228 COMPLETE KIT GAS ISO 228		1
Composizione KIT Composition KIT			
002452N	Punzonatrice oleodinamica Hydraulic punching machine		1
00PT11	Perno tondo 11 mm Round Pin 11 mm		1
00PT16	Perno tondo 16 mm Round Pin 16 mm		1
003001	Fustella tonda 17 mm Round punch 17 mm	3/8"	1
003003	Fustella tonda 21 mm Round punch 21 mm	1/2"	1
003007	Fustella tonda 26,5 mm Round punch 26.5 mm	3/4"	1
003109	Fustella tonda 33,5 mm Round punch 33.5 mm	1"	1
003015	Fustella tonda 42 mm Round punch 42 mm	1"1/4	1
003017	Fustella tonda 48 mm Round punch 48 mm	1"1/2	1
003022	Fustella tonda 60,5 mm Round punch 60.5 mm	2"	1
004104P	Valigia Case		1



Materiale per punzonare Metrico Metric Punching Material

CODICE CODE	DESCRIZIONE DESCRIPTION	DIAMETRO DIAMETER ø mm	QUANTITÀ QUANTITY
002454ISO	KIT COMPLETO METRICO COMPLETE KIT METRIC		1
Composizione KIT Composition KIT			
002452N	Punzonatrice oleodinamica Hydraulic punching machine		1
00PT11	Perno tondo 11 mm Round Pin 11 mm		1
00PT16	Perno tondo 16 mm Round Pin 16 mm		1
003M162	Fustella tonda 16,2 mm Round punch 16,2 mm	M16	1
003M204	Fustella tonda 20,4 mm Round punch 20,4 mm	M20	1
003M254	Fustella tonda 25,4 mm Round punch 25,4 mm	M25	1
003M325	Fustella tonda 32,5 mm Round punch 32,5 mm	M32	1
004104P	Valigia Case		1

■ Attrezzature Equipments

Cilindri perforatori Drilling Cylinders

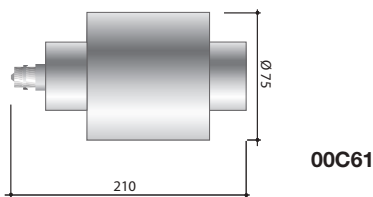

00C61

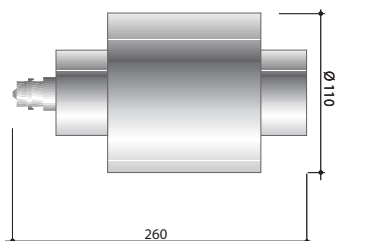

00C90



00C92



00RC90

Cilindri oleodinamici a semplice effetto che possono essere collegati a tutte le pompe o centraline Linea Cosmec.

Servono per effettuare forature su lamiere, tubi, serbatoi ecc., con l'ausilio di appositi punzoni.

Sono prodotti in due versioni per soddisfare un'ampia gamma di esigenze. Sono forniti con innesto rapido maschio CEJN da 1/4".

Il cilindro 00C90 può utilizzare i perni per cilindro 00C61 usando la riduzione cod. 00RC90; per le fustelle con perno 00PT11 utilizzare l'anello cod. 00C92 interponendolo tra il cilindro e la femmina delle fustelle.

Single-acting hydraulic cylinders that may be quick-coupled to all Cosmec Line pumps or controllers.

Used to drill plates, pipes, tanks, etc., with the aid of suitable punches.

Produced in two versions to meet a wide range of needs.

Supplied with Cejn 1/4" male quick-action coupling.

The cylinder 00C90 can use the pins for the cylinder 00C61 using the reduction cod. 00RC90; for the punches with pin 00PT11 use the ring cod. 00C92 inserting it between the cylinder and the female fitting of the punches.

CODICE CODE	DESCRIZIONE DESCRIPTION	PRESSIONE PRESSURE MPa / bar	FORZA MAX WEIGHT kN	MASSA TOTALE TOTAL WEIGHT Kg	NOTE NOTES
00C61	Cilindro ø 75 Cylinder ø 75	70 (700bar)	160	3	
00C90	Cilindro ø 110 Cylinder ø 110	70 (700bar)	350	7,8	Per forature di grandi dimensioni (superiori a Ø 200 mm). For large size drilling (exceeding 200 mm Ø).
00C92	Anello Ring				
00RC90	Riduzione Reduction				

Adattatori per utensili e cilindri Adapters for tools and cylinders



Accessori che consentono l'intercambiabilità d'utilizzo di utensili e cilindri Linea Cosmec con quelli di altri costruttori.

Accessories that allow interchangeability of Cosmec Line tools and cylinders with those of other manufacturers.

CODICE CODE	CILINDRO DIAMETER ø mm	PERNO E UTENSILI PIN AND TOOLS	FILETTO MASCHIO MALE THREAD	FILETTO FEMMINA FEMALE THREAD	PESO WEIGHT Kg
002452-1634	Cosmec	Altri costruttori Other manufacturers	M16x1,5	¾"UNF	0,460
002452-3416	Altri costruttori Other manufacturers	Cosmec	¾"UNF	M16x1,5	0,024

■ Sistema di foratura Drilling system

Fustelle Punches



Questi utensili, costruiti in acciai speciali temprati, sono indispensabili per realizzare perfette forature nei pannelli dei quadri elettrici in quanto non rovinano la verniciatura e sono utilizzabili anche da personale non necessariamente specializzato.

Sono eseguiti in varie forme e dimensioni: rotondi, quadri, rettangolari ed anche con profili irregolari.

Le dimensioni più ricorrenti nelle varie esecuzioni sono disponibili a magazzino. Altre misure sono disponibili a richiesta. Tutti questi utensili possono forare lamiere in acciaio Fe370, inox, alluminio e materiali plastici. Gli spessori massimi consentiti sono specificati per ogni articolo nelle tabelle di riferimento.

These tools, made in special hardened steel, are indispensable to achieve perfect holes in switchboards panels because they do not spoil the painting and can be used even by unskilled staff.

They are produced in various forms and dimensions: round, square, rectangular and even with irregular profiles.

The most used sizes in the various executions are available in stock.

Other sizes are available on request.

All these tools can drill steel Fe370, stainless steel, aluminium and plastic materials.

Maximum thickness permitted are specified for each article in the reference tables.

Quadre Square



CODICE CODE	DIMENSIONI DIMENSIONS Ø mm	PERNO ABB. PIN COMB.	PREFORO PRE-HOLE ø mm	SPESSORI THICKNESS		
				AISI 304	Fe 370	Al/Plast.
007001	20	00PQ08	17	2	2,5	5
007002*	24	00PQ08	17	2	2,5	5
007003	30	00PQ12	19,5	2	2,5	5
007004*	40	00PQ14	19,5	2	2,5	5
007018	45	00PQ14	19,5	2	2,5	5
007005	46	00PQ14	19,5	2	2,5	5
007006*	50	00PQ20	28,5	2	2,5	5
007007*	57	00PQ20	28,5	2	2,5	5
007008	68	00PQ20	28,5	2	2,5	5
007009	92	00PQ20	28,5	2	2,5	5
007010*	104	00PQ22	28,5	2	2,5	5
007011*	138	00PQ22	28,5	2	2,5	5

* A richiesta / On request

Perni per fustelle quadre Pins for square punches



CODICE CODE	CILINDRO CYLINDER
	ø mm
00PQ08	00C61
00PQ12	00C61
00PQ14	00C61
00PQ20	00C61
00PQ22	00C61

■ Sistema di foratura Drilling system

Fustelle Rettangolari Rectangular Punches



CODICE CODE	DIMENSIONI DIMENSIONS Ø mm	PERNO ABB. PIN COMB.	PREFORO PRE-HOLE ø mm	SPESSORI THICKNESS		
				AISI 304	Fe 370	Al/Plast.
005102*	22x26	00PQR08	17	2	2,5	5
005101*	20x36	00PQR12	19,5	2	2,5	5
005103*	22x30	00PQR08	17	2	2,5	5
005106*	22x46	00PQR12	19,5	2	2,5	5
005112*	29x51	00PQR14	19,5	2	2,5	5
005258	29x71	00PQR14	19,5	2	2,5	5
005285*	30x50	00PQR14	19,5	2	2,5	5
005116*	32x51	00PQR14	19,5	2	2,5	5
005118*	34x61	00PQR14	19,5	2	2,5	5
005121	36x46	00PQR14	19,5	2	2,5	5
005123*	38x65	00PQR14	19,5	2	2,5	5
005120*	34x85	00PQR20	28,5	2	2,5	5
005127*	43x91	00PQR20	28,5	2	2,5	5
005303	45x93	00PQR20	28,5	2	2,5	5
005130	46x72	00PQR20	28,5	2	2,5	5
005131	46x92	00PQR20	28,5	2	2,5	5
005136*	52x72	00PQR20	28,5	2	2,5	5
005138*	53x63	00PQR20	28,5	2	2,5	5
005132*	46x107	00PQR22	28,5	2	2,5	5
005134*	50x57	00PQR20	28,5	2	2,5	5
005143*	65x100	00PQR22	28,5	2	2,5	5
005144*	68x138	00PQR22	28,5	2	2,5	5
005147*	100x120	00PQR22	28,5	2	2,5	5

* A richiesta / On request

Perni per fustelle rettangolari Pins for rectangular punches



CODICE CODE	CILINDRO CYLINDER
00PQR08	00C61
00PQR12	00C61
00PQR14	00C61
00PQR20	00C61
00PQR22	00C61

■ Sistema di foratura Drilling system

Fustelle tonde Round punches



CODICE CODE	DIMENSIONI DIMENSIONS			PERNO ABB. PIN COMB.	PREFORO PRE-HOLE	SPESSORI THICKNESS		
	Ø mm	Ø GAS	Ø PG			Ø mm	AISI 304	Fe 370
003122	15,5	-	9	00PT11	11,5	2	2,5	5
003001	17	3/8"	-	00PT11	11,5	2	2,5	5
003139	18,5	-	-	00PT11	11,5	2	2,5	5
003002	19,5	-	11	00PT11	11,5	2	2,5	5
003003	21	1/2"	13	00PT11	11,5	2	2,5	5
003004	22,5	-	16	00PT11	11,5	2	2,5	5
003005*	24	5/8"	-	00PT11	11,5	2	2,5	5
003007	26,5	3/4"	-	00PT11	11,5	2	2,5	5
003008	28,5	-	21	00PT11	11,5	2	2,5	5
003009	30,5	7/8"	-	00PT11	11,5	2	2,5	5
003109	33,5	1"	-	00PT16	17	2	2,5	5
003012	35	-	-	00PT16	17	2	2,5	5
003110	37	-	29	00PT16	17	2	2,5	5
003013	38,5	1"1/8	-	00PT16	17	2	2,5	5
003015	42	1"1/4	-	00PT16	17	2	2,5	5
003016	45	-	-	00PT16	17	2	2,5	5
003113	47	-	-	00PT16	17	2	2,5	5
003017	48	1"1/2	36	00PT16	17	2	2,5	5
003019	54	1"3/4	42	00PT16	17	2	2,5	5
003020	55,5	-	-	00PT16	17	2	2,5	5
003021*	57	-	-	00PT16	17	2	2,5	5
003022	60,5	2"	48	00PT16	17	2	2,5	5
003023*	62	-	-	00PT16	17	2	2,5	5
003024	65	-	-	00PT16	17	2	2,5	5
003025	70,5	-	-	00PT16	17	2	2,5	5
003026*	72	-	-	00PT16	17	2	2,5	5
003027	75	2"1/2	-	00PT22	22,5	2	2,5	5
003028	80,5	-	-	00PT22	22,5	2	2,5	5
003029	91	3"	-	00PT22	22,5	2	2,5	5
003030	105	-	-	00PT27	28,5	2	2,5	5
003031	115	4"	-	00PT27	28,5	2	2,5	5
003032*	120	-	-	00PT27	28,5	2	2,5	5
003033*	130	-	-	00PT27	28,5	2	2,5	5
003034*	140	5"	-	00PT27	28,5	2	2,5	5

* A richiesta / On request

Fustelle per foro metrico Punches for metric hole

CODICE CODE	DIMENSIONI DIMENSIONS		PERNO ABB. PIN COMB.	PREFORO PRE-HOLE	SPESSORI THICKNESS		
	Ø mm	Ø M			Ø mm	AISI 304	Fe 370
003M162	16,2	M16	00PT11	11,5	2	2,5	5
003M204	20,4	M20	00PT11	11,5	2	2,5	5
003M254	25,4	M25	00PT11	11,5	2	2,5	5
003M325	32,5	M32	00PT16	17	2	2,5	5
003M405	40,5	M40	00PT16	17	2	2,5	5
003M505	50,5	M50	00PT16	17	2	2,5	5
003M635	63,5	M63	00PT16	17	2	2,5	5

Perni per fustelle tonde Pins for round punches



CODICE CODE	FILETTATURA THREAD	PERNO ABB. PIN COMB.
00PT11	M11-M16	00C61
00PT16	M16-M16	00C61
00PT22	M16-M22	00C61
00PT27	M16-M27	00C61
00PT27L (> Ø 140 mm)	M16-M27	00C61

■ Sistema di foratura Drilling system

Fustelle per lamiera in acciaio inox Punches for stainless steel sheet

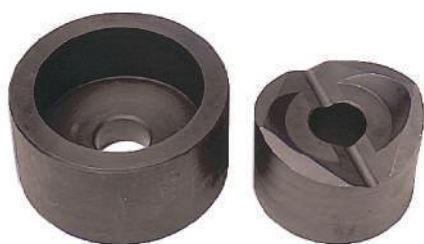

Questi utensili, realizzati con acciai speciali temprati, sono atti a sopportare sforzi notevoli con un'ottima resistenza all'abrasione. Consentono di forare lamiere in acciaio inox di spessore fino a 4 mm. Sono usati con i cilindri 00C90 e 00C61 e trovano impiego nella lavorazione di lamiere e serbatoi usati nelle macchine per la trasformazione di prodotti alimentari.

These tools, made in special hardened steels can withstand considerable pressure with excellent resistance to abrasion. They allow drilling on stainless steel sheets with a thickness of up to 4mm. They are used with 00C90 and 00C61 cylinders in the processing of sheets and tanks used for food processing machines.

CODICE CODE	DIMENSIONI DIMENSIONS Ø mm	PERNO ABB. PIN COMB.	PREFORO PRE-HOLE ø mm	SPessori THICKNESS		CILINDRO CYLINDER
				INOX AISI 304	Fe 370	
XX33155	15,5	XXPT11	14,5	3	4	
XX3317	17	XXPT11	14,5	3	4	
XX3318	18	XXPT11	14,5	3	4	
XX3319	19	XXPT11	14,5	3	4	
XX3320	20	XXPT11	14,5	3	4	
XX3321	21	XXPT11	14,5	3	4	
XX3322	22	XXPT11	14,5	3	4	
XX33225	22,5	XXPT11	14,5	3	4	
XX3323*	23	XXPT11	14,5	3	4	00C61 00C90+00RC90
XX3325*	25	XXPT11	14,5	3	4	
XX3326*	26	XXPT11	14,5	3	4	
XX3328*	28	XXPT16	20	3,5	4,5	
XX3330*	30	XXPT16	20	3,5	4,5	
XX3332*	32	XXPT16	20	3,5	4,5	
XX3338*	38	XXPT16	20	3,5	4,5	
XX3340*	40	XXPT16	20	3,5	4,5	
XX3348*	48	XXPT16	20	3,5	4,5	
XX3350*	50	XXPT22	25	4	5	
XX3352*	52	XXPT22	25	4	5	
XX3360*	60	XXPT22	25	4	5	
XX3370*	70	XXPT22	25	4	5	00C90
XX3380*	80	XXPT27	30	4	5	
XX3390*	90	XXPT27	30	4	5	
XX3310*	100	XXPT27	30	4	5	

* A richiesta / On request

Perni tondi per fustelle inox Round pins for stainless steel punches



CODICE CODE	CILINDRO CYLINDER
XXPT11	00C61 00C90+00RC90
XXPT16	00C61 00C90+00RC90
XXPT221	00C61
XXPT222	00C90
XXPT271	00C61
XXPT272	00C90
XXPT27L1 (> Ø 140 mm)	00C61
XXPT27L2 (> Ø 140 mm)	00C90

■ Sistema di foratura Drilling system

Fustelle per connettori Punches for connectors

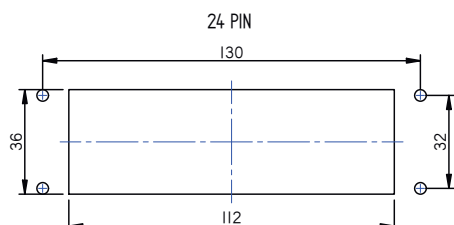
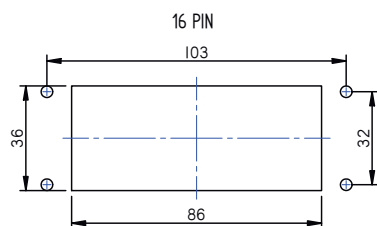
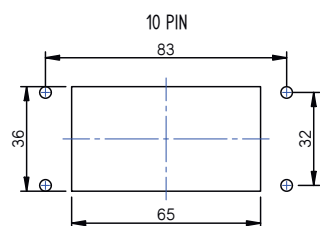
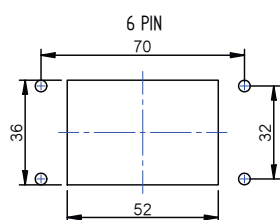

Utensili prodotti con acciai speciali temprati, appositamente studiati per realizzare le feritoie dei connettori di potenza standard.

Operazioni agevolate grazie a:

- indicazione degli interassi di foratura per il fissaggio del connettore;
- estrazione rapida del truciolo tramite finestra laterale;
- utensile compatto e composto da solo due componenti.

Il codice di acquisto comprende utensili maschio e femmina, perno e valigia. L'azionamento è possibile mediante i cilindri Linea Cosmec cod. 00C61 o pompa manuale 002452N.

Per strumenti di azionamento con attacchi $\frac{3}{4}$ UNF, è necessaria la riduzione cod. 002452-3416.

Tools made in special hardened steels, especially designed to make the slots of the standard power connectors.

Operations facilitated thanks to:

- indication of the drilling spacing (centre to centre) for the mounting of the connector;
- rapid extraction of the chip through the side window;
- compact tool composed of only two components.

The code includes female and male tools, pin and case.

The tool is driven by Cosmec Line cod. 00C61 cylinders or 002452N manual pump.

For drive tools with connections $\frac{3}{4}$ UNF, it is necessary to use the reduction cod. 002452-3416.

CODICE CODE	DIMENSIONI DIMENSIONS mm	RIF.CONNETTORE CONNECTOR REF.	SPESSORE FE370 THICKNESS FE370	PREFORO PRE-HOLE ø mm
005456SC-B	36x52	6 PIN	2	28,5
005161SC-B	36x65	10 PIN	2	28,5
005205SC-B	36x86	16 PIN	2	28,5
005377SC-B	36x112	24 PIN	2	28,5



■ Attrezzature Equipments

Piega forabarre Bar bender and piercer

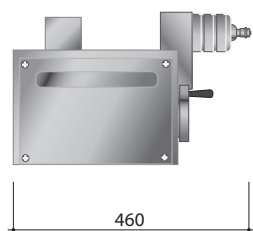
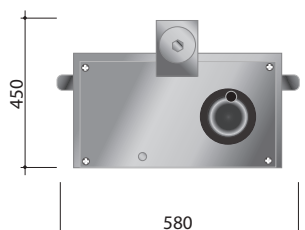

Per cablaggio quadri elettrici in cui è necessario piegare e forare barre rigide o flessibili di rame ed alluminio.

Attrezzatura costituita da un monoblocco in acciaio speciale, completamente aperto per consentire l'agevole introduzione delle barre dall'alto. La robustezza di questa struttura garantisce, anche dopo anni, un'altissima precisione nell'esecuzione dello stesso.

Il corpo macchina può muoversi verticalmente grazie ad un dispositivo oleodinamico azionato da un volantino posto nella parte anteriore del banco.

Una riga graduata ed un fermobarra consentono di posizionare le barre in modo preciso e ripetitivo.

Può essere dotato di un programmatore di piega Kit Encoder cod. 009101.

Piegatura

Da 5 mm a 12 mm di spessore per un'altezza massima di 120 mm.

Foratura

Fino a 10 mm di spessore.

Foratura su spessore 12 mm è possibile ma implica un degrado delle molle di estrazione. Per un corretto uso dei punzoni non forare spessori superiori al diametro del punzone stesso.

I punzoni di foratura sono da richiedere separatamente.

Composto da:

- Cilindro
- Basamento
- Utensile piega
- Goniometro elettrico solo cod.009012-B
- Goniometro manuale solo cod.009011-B
- Sensore foratura solo cod.009012-B
- Fermobarra

Caratteristiche

- Impostazione angolo piega con arresto e ritorno automatico in posizione iniziale
- Foratura con ritorno automatico in posizione iniziale (codice 009012-B)
- Riferimenti visivi per controllo piega ed avvenuta foratura (codice 009011-B)

For wiring electric switchboards in which it is necessary to bend and pierce rigid or flexible copper and aluminium bars.

Tool consisting of a mono block made of special steel, completely open to permit the bars to be easily inserted from the top. The strength of this structure ensures high precision, even after years of operation.

The machine can move vertically thanks to a hydraulic device controlled by a hand wheel placed in the front part of the work bench.

A gauge and a bar holder make it possible to precisely centre the bar every time.

It can also be equipped with a bend programmer Kit Encoder code 009101.

Bending

From 5 mm to 12 mm thickness for a maximum height of 120 mm.

Drilling

Up to 10 mm thickness.

Drilling on 12 mm thickness is possible but this causes premature wear and tear on the extraction spring. For a correct use of the punches do not punch material thicker than the diameter of the punch itself.

The piercing punches must be ordered separately.

Composed of:

- Cylinder -
- Base -
- Tool bender -
- Electrical goniometer code 009012-B
- Manual goniometer code 009011-B
- Drilling sensor
- Bar holder

Characteristics

- Setting bender angle with stop and automatic return in starting position
- Drilling with automatic return in starting position (code 009012-B)
- Visual references for bending control and drilling executed (code 009011-B)

CODICE CODE	AZIONAMENTO OPERATED l/min	PRESSIONE DESCRIPTION MPa	FORZA MAX SVILUPPATA WEIGHT kN	MASSA TOTALE TOTAL WEIGHT Kg
009012-B	CENTRALINA cod.00HP1550 CONTROLLER code00HP1550	70 (700bar)	230	59,5
009011-B	POMPE cod.00PA2002 - 00PA2004 PUMPS code00PA2002 - 00PA2004	70 (700bar)	230	59,5

Forme minime di piegatura (mm)
Minimum bending shapes (mm)



■ Attrezzature Equipments

Piega forabarre elettronico Electronic bar bender and piercer

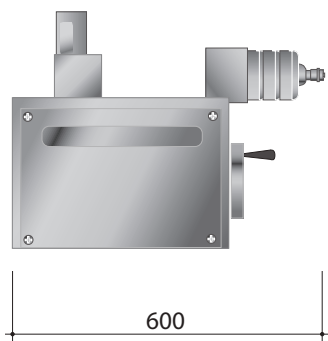
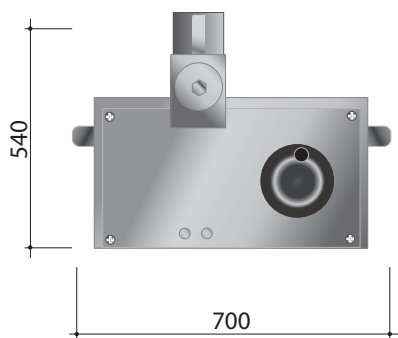

Attrezzatura per cablare quadri elettrici in cui è necessario piegare e forare barre rigide o flessibili di rame ed alluminio. Attrezzatura costituita da un monoblocco in acciaio speciale, completamente aperto per consentire l'agevole introduzione delle barre dall'alto. La robustezza di questa struttura è tale da garantire, anche dopo anni di lavoro, sempre un'altissima precisione nell'esecuzione dello stesso. Il corpo macchina può muoversi verticalmente grazie ad un dispositivo oleodinamico azionato da un volantino posto nella parte anteriore del banco. Una riga graduata applicata su di un fianco del corpo macchina ed un fermobarra regolabile con riga graduata, consentono di posizionare le barre in modo preciso e ripetitivo. Dotato di un programmatore di piega controllato da un Encoder che consente anche minime regolazioni per correggere l'elasticità delle barre da curvare. Un selettore permette la commutazione del controllo di piegatura e di foratura, consentendo anche per quest'ultima operazione l'arresto automatico a lavoro eseguito.

Piegatura

Da 5 mm a 12 mm di spessore per un'altezza massima di 120 mm.

Foratura

Fino a 10 mm di spessore. La foratura su spessore di 12 mm è possibile ma implica un precoce degrado delle molle di estrazione. Per un corretto uso dei punzoni è suggerito non forare spessori superiori al diametro del punzone stesso.

Completo di:

- centralina elettroidraulica incorporata
- encoder per il controllo della piega
- programmatore angolo di piega

I punzoni di foratura sono da richiedere separatamente.

Tool for wiring electric switchboards in which it is necessary to bend and drill rigid or flexible copper and aluminium bars. Tool consisting of a mono block made of special steel, completely open to permit the bars to be easily inserted from the top. The strength of this structure ensures, even after years of operation, high precision in the execution of the work. The machine can move vertically thanks to a hydraulic device controlled by a hand wheel placed in the front part of the work bench.

A gauge applied on one side of the machine body and an adjustable bar holder make it possible to precisely position the bar every time.

Equipped with an Encoder-controlled bend programmer which enables high precision adjustments to correct the elasticity of the bars to be bent.

A switch selects bending or piercing control and ensures that the unit stops automatically when the task is completed.

Bending

From 5 mm to 12 mm thickness for a maximum height of 120 mm.

Drilling

Up to 10 mm thickness. Drilling on 12 mm thickness is possible but this causes premature wear and tear on the extraction spring. For a correct use of the punches do not punch material thicker than the diameter of the punch itself.

Includes:

- built-in electro-hydraulic controller
- encoder-controlled bending
- programmer for setting bending angle

The piercing punches must be ordered separately.

CODICE CODE	PRESSIONE PRESSURE MPa / bar	FORZA MAX SVILUPPATA MAX POWER DEVELOPED kN	PORTATA OIL FLOW l/min	ALIMENTAZIONE POWER SUPPLY	TENSIONE COMANDI VOLTAGE V	ASSORBIMENTO ABSORPTION kW	MASSA TOTALE TOTAL WEIGHT Kg
009100	53 (530bar)	175	0,82	220V-50Hz	24	0,37	90

Forme minime di piegatura (mm)

Minimum bending shapes (mm)

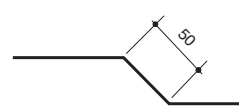
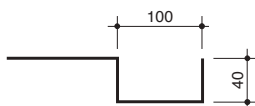

■ Attrezzature Equipments

Punzoni per barre Bar punches



Realizzati con acciai temprati e rettificati e sono costituiti da un punzone e una matrice con le dimensioni di foratura stampigliate su entrambi i particolari per evitare errori di accoppiamento. Sui punzoni è montata una molla che ne garantisce l'estrazione dalla barra forata. I punzoni e le matrici per fori ad asola hanno dei riferimenti per il corretto orientamento delle stesse. Sono progettati per forare fino a 10 mm di spessore ma, per un più corretto utilizzo, **si consiglia di non forare barre con uno spessore superiore al diametro del punzone**. Sono idonei per la foratura di barre rigide o flessibili di rame ed alluminio. Se si prevedono forature di barre flessibili è necessario specificarne l'applicazione al momento dell'acquisto.

These tools are made in special hardened and ground steel and consist of a punch and a matrix whose drilling dimensions are printed on both parts to avoid connecting errors. A spring is mounted on the punches to ensure the extraction of the punch from the drilled bar. The punches and dies used for slotted holes have reference marks for correct positioning.

They are designed for piercing of up to 10 mm in thickness, but for a more correct use **do not punch bars thicker than the diameter of the punch itself**.

Suitable for piercing rigid or flexible copper and aluminium bars.

When piercing flexible bars, it is necessary to specify the application at the time of purchase.

Punzoni tondi Round punches

CODICE CODE	FORO HOLE Ø mm	PER VITE (S) FOR SCREW	SPESS.MAX MAX THICKNESS mm
00907-055M	5,5	M5	5
00907-055F	5,5	M5	5
00907-066M	6,6	M6	6
00907-066F	6,6	M6	6
00907-090M	9	M8	8
00907-090F	9	M8	8
00907-110M	11	M10	10
00907-110F	11	M10	10
009007-12M	12,5	-	10
009007-12F	12,5	-	10
00907-140M	14	M12	10
00907-140F	14	M12	10
009007-16M	16,5	-	10
009007-16F	16,5	-	10
00907-180M	18	M16	10
00907-180F	18	M16	10
009007-22M	22,5	M20	10
009007-22F	22,5	M20	10

(S) dati ricavati dalla tabella per forature di collegamento a vite per giunzioni di barre, CNR-CEI unel 01432-72.

(S) data obtained from the reference table for drilling screw connection for bar joints, CNR-CEI unel 01432-72.

Punzoni ad asola Slot punches

CODICE CODE	FORO HOLE Ø mm	SPESS.MAX MAX THICKNESS mm
009008-09M	9 x 15	10
009008-09F	9 x 15	10
009008-01M	11 x 17	10
009008-01F	11 x 17	10
009008-04M	13,5 x 19	10
009008-04F	13,5 x 19	10
009008-05M	17,5 x 22	10
009008-05F	17,5 x 22	10

■ Attrezzature Equipments

Utensile tagliabarre Bar cutter



Cod. 009018

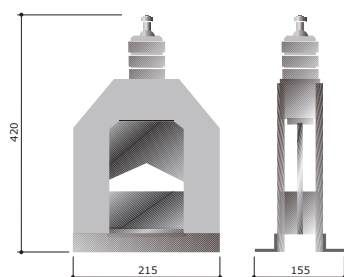

Il Tagliabarre è un utensile in grado di tagliare barre in rame e alluminio delle dimensioni massime di 120x12 mm. Il taglio avviene a freddo e senza generare deformazioni e/o bave nella barra in quanto l'operazione è velocissima.

Per l'azionamento dell'utensile si possono utilizzare tutte le macchine idrauliche operatrici di Cosmec, come la pompa oleodinamica a pedale Cod.art. 00PA2002, quella pneumoidraulica cod. art. 00PA2004 o la centralina elettroidraulica cod. 00HP1550.

Non è obbligatorio fissare l'attrezzo durante l'operazione di taglio; tuttavia è prevista la possibilità di ancorare l'attrezzatura ad un piano di lavoro fissandone i piedi mediante l'utilizzo di 4 viti M8.

L'accessorio cod. 009018K kit supporto e centraggio barra agevola notevolmente le operazioni di centraggio ed assicura l'ortogonalità del taglio grazie alle due superfici di appoggio ed i fermo barra regolabili in larghezza e spessore barra.

The Bar Cutter is a tool able to cut 120x12 mm copper and aluminium bars.

The bars are cold cut and do not cause deformation on the bar as the operation is very fast. To operate the tool it is possible to use all the Cosmec hydraulic machines, such as the hydraulic pump with pedal code 00PA2002, the pneumohydraulic pump code 00PA2004 or the electro-hydraulic controller code 00HP1550.

It is not necessary to secure the tool during the cutting operation; however, it is possible to anchor the equipment to a work bench by fixing the feet using 4 M8 screws. The accessory with code 009018K bar cutter support kit and bar centring considerably facilitates the centring operations and ensures the orthogonality of the cut thanks to the two retainer surfaces and to the retainer bar adjustable in width and thickness of bar.

L'accessorio cod. 009018K può essere acquistato separatamente ed installato su attrezzi esistenti.

The accessory with code 009018K can be purchased separately and installed on existing tools.

Pressione max di esercizio **70Mpa**
Forza sviluppata **230kN**

Max working pressure **70Mpa**
Developed power **230kN**



Cod. 009018-1

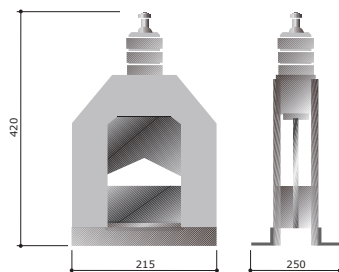

CODICE CODE	DESCRIZIONE DESCRIPTION	PESO WEIGHT Kg
009018	Utensile taglia barre standard Standard bar cutter	18
009018-1	Versione con kit supporto e centraggio barra Version with bar cutter support kit and bar centring	22
009018K	Kit supporto e centraggio barra Support kit and bar centering	4



Cod. 009018K

■ Banco di lavoro Work bench

Multiuso 008800

Multi-use 008800

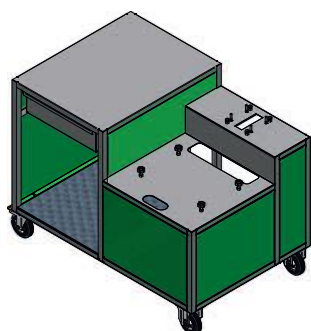

cod.008800
Senza impianto idraulico
Without hydraulic system

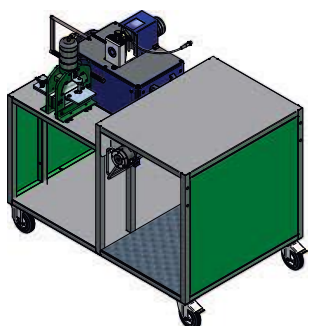

cod.008802
Completo di impianto per azionare n.2 utensili
Complete system to operate n.2 tools

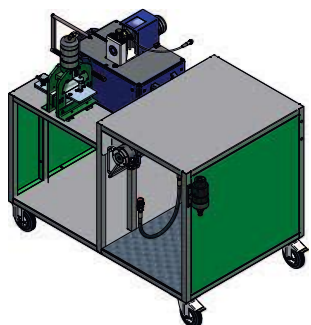

cod.008803
Completo di impianto per azionare
n.3 utensili e n.1 supporto
Complete system to operate
n.3 tools and n.1 support

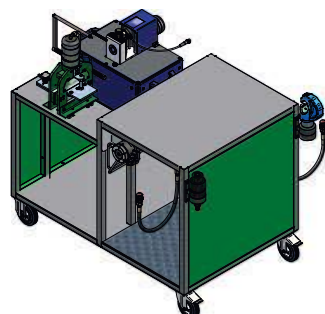

cod.008804
Completo di impianto per azionare
n.4 utensili e n.2 supporti
Complete system to operate
n.4 tools and n.2 supports

Banco di lavoro multiuso da officina, predisposto per l'alloggiamento di attrezzature prodotte da DKC Linea Cosmec.

E' costituito da un robusto telaio in acciaio zincato con un ampio piano di lavoro, un piano inferiore per alloggiare la centralina elettroidraulica ed altri eventuali accessori, un cassetto per contenere gli utensili, i supporti regolabili per l'allineamento tra gli attrezzi ed il piano e quattro ruote per consentirne lo spostamento.

L'impianto idraulico del banco è dotato di un distributore idraulico che consente di selezionare la macchina da azionare (sempre singolarmente).

Le principali peculiarità di questo banco sono:

- possibilità di alloggiare sia attrezzature nuove che usate;
- possibilità di selezionare la macchina da azionare senza ricollegare i tubi;
- possibilità di rimuovere con facilità ogni singolo attrezzo.

**Dimensioni 1175x780 h904 mm
Peso 130kg**

Multi-use work bench for workshops, suitable for housing equipment produced by DKC's Cosmec Line.

It is composed of a strong galvanized steel frame with a wide work surface, a lower surface to accommodate the electro hydraulic unit and any other accessories, a drawer for the tools, adjustable supports for the alignment between tools and work bench and four wheels to facilitate movement.

The hydraulic system of the bench is equipped with a hydraulic distributor that allows you to select the machine to operate (always individually).

The main peculiarities of this bench are:

- possibility to accommodate new and used equipment;
- possibility to select the machine to operate without re-connect the pipes;
- possibility to easily remove every single piece of equipment.

**Size 1175x780 h904 mm
Weight 130kg**

CODICE CODE	DESCRIZIONE DESCRIPTION	UTENSILI TOOLS	SUPPORTO SUPPORT
008800	Banco di lavoro Work bench	Senza Impianto Idraulico Without hydraulic plant	
008802	Banco di lavoro Work bench	2	-
008803	Banco di lavoro Work bench	3	1
008804	Banco di lavoro Work bench	4	2

Attrezzature alloggiabili

Tutte le attrezzature sono da acquistare separatamente.

Le caratteristiche di ogni macchina o utensile sono indicate nelle rispettive pagine del catalogo.

Equipment that can be housed

All the equipments have to be bought separately.

The characteristics of each machine or tool appears on the respective pages of the catalogue.

CODICE CODE	DESCRIZIONE DESCRIPTION
00HP1550	Centralina elettroidraulica Electro hydraulic unit
009012-B	Piega fora barre Bar bender and drillin tool
009018/009018-1	Tagliabarre Bar cutter
00C61	Cilindro perforatore - Cilindro Aggraffatore Drilling cylinders

■ Accessori Accessories

Kit encoder Kit encoder



Accessorio installabile su tutti i modelli di piegabarre Cod. 009011-B e 009012-B prodotti dal 1980 ad oggi.
Consiste in un programmatore di piega che controlla un encoder portato in rotazione dal movimento della barra durante la piega; al raggiungimento dell'angolo impostato la centralina elettroidraulica si arresta.
Questo dispositivo consente di effettuare minime variazioni nell'impostazione dell'angolo della piega al fine di recuperare le diverse elasticità delle barre.
La precisione nel controllo della piega fa sì che la ripetitività delle operazioni sia uniforme.

Accessory to be installed on all benders code 009011-B and 009012-B, manufactured since 1980.
It is a bend programmer that controls an encoder which rotates with the bar during the bending process and, once the desired angle has been obtained, automatically stops.
This device can handle even small variations in the bending angle to respond to a range of bar flexibility.
The precision in the control of the fold makes the repeatability of the operations uniform.

CODICE
CODE

DESCRIZIONE
DESCRIPTION

009101

Programmatore di piega
Bend programmer

Pedaliera di comando Control pedal



CODICE
CODE

DESCRIZIONE
DESCRIPTION

008005

Pedaliera di Comando
Control pedal

Morsetto da banco Bench clamp



CODICE
CODE

DESCRIZIONE
DESCRIPTION

008000

Morsetto da banco per cod.00C61
Bench clamp for code 00C61

■ Accessori Accessories

Innesto Rapido Quick coupling



CODICE CODE	DESCRIZIONE DESCRIPTION
00IRF-A	Innesto rapido femmina "CEJN" 1/4" Cejn 1/4" female quick coupling
00IRM-A	Innesto rapido maschio "CEJN" 1/4" Cejn 1/4" male quick coupling

Dispositivo azionamenti Command devices



CODICE CODE	DESCRIZIONE DESCRIPTION
00A9000	Dispositivo azionamenti per 2 cilindri Control device for 2 cylinders
00A9001	Dispositivo azionamenti per 3 cilindri Control device for 3 cylinders

Valvola di regolazione Regulating valve



CODICE CODE	DESCRIZIONE DESCRIPTION
009006	Valvola di regolazione Regulating valve

Adattatore Adapter



CODICE CODE	DESCRIZIONE DESCRIPTION
00IRA-P	Adattatore innesto maschio a vite innesto femmina rapida Adaptor male screw connection female quick coupling

Prolunga con innesti Extension with connections



CODICE CODE	DESCRIZIONE DESCRIPTION
008101	Prolunga di 2 m con innesti 2 m extension with connections

■ Accessori Accessories

Adattatore Adapter



CODICE
CODE

DESCRIZIONE
DESCRIPTION

00IRA-C

Adattatore innesto maschio rapido innesto femmina a vite
Adaptor male quick coupling female screw connection

Goniometro Goniometer



CODICE
CODE

DESCRIZIONE
DESCRIPTION

009003-A

Goniometro manuale
Manual goniometer

009004-A

Goniometro elettrico
Electrical goniometer

Cassetta per 00PA2002 Case for 00PA2002



CODICE
CODE

DESCRIZIONE
DESCRIPTION

004105

Cassetta per 00PA2002
Case for 00PA2002

Valigia Case



CODICE
CODE

DESCRIZIONE
DESCRIPTION

004104P

Valigia per 002250/002251, 002452C/002454N/002455N, 002456N/002454ISO
Case for 002250/002251, 002452C/002454N/002455N, 002456N/002454ISO

Olio idraulico Hydraulic oil



CODICE
CODE

DESCRIZIONE
DESCRIPTION

008102

Olio idraulico rispondente alle specifiche ISO-L-FC per pompe - 1 litro
Hydraulic oil that meets the ISO-L-FC specification for pumps - 1 liter

■ Indice codici

Code index

00A9000	226	003003	217	007010	215	50DUO-10N	153
00A9001	226	003004	217	007011	215	50DUO-12N	153
00C61	214	003005	217	007018	215	50DUO-17N	153
00C90	214	003007	217	008000	225	50DUO-23N	153
00C92	214	003008	217	008005	225	50DUO-29N	153
00HP1550	211, 224	003009	217	008101	226	50DUO-36N	153
00IRA-C	227	003012	217	008102	227	50DUO-48N	153
00IRA-P	226	003013	217	008800	224	50DUO-65N	153
00IRF-A	226	003015	217	008802	224	50HT-07N	144
00IRM-A	226	003016	217	008803	224	50HT-07N	144
00IRM-A	226	003017	217	008804	224	50HT-10N	144
00PA2002-C	210	003019	217	009003-A	227	50HT-12N	144
00PA2004	210	003020	217	009004-A	227	50HT-17N	144
00PQ08	215	003021	217	009004-A	227	50HT-22N	144
00PQ12	215	003022	217	009006	226	50HT-28N	144
00PQ14	215	003023	217	00907-055F	222	50HT-36N	144
00PQ20	215	003024	217	00907-055M	222	50HT-48N	144
00PQ22	215	003025	217	00907-066F	222	50NF-07N	145
00PQR08	216	003026	217	00907-066M	222	50NF-07TX	146
00PQR12	216	003027	217	00907-090F	222	50NF-10N	145
00PQR14	216	003028	217	00907-090M	222	50NF-10TX	146
00PQR20	216	003029	217	00907-110F	222	50NF-12N	145
00PQR22	216	003030	217	00907-110M	222	50NF-12TX	146
00PT11	217	003031	217	009007-12F	222	50NF-17N	145
00PT16	217	003032	217	009007-12M	222	50NF-17TX	146
00PT22	217	003033	217	00907-140F	222	50NF-23N	145
00PT27	217	003034	217	00907-140M	222	50NF-23TX	146
00PT27L	217	003109	217	00907-180F	222	50NF-29N	145
00RC90	214	003110	217	00907-180M	222	50NF-29TX	146
001103-1	208	003113	217	009007-16F	222	50NF-36N	145
001103-1BC	209	003122	217	009007-16M	222	50NF-36TX	146
001103-A	208	003139	217	009007-22F	222	50NF-48N	145
001103-A1	208	004104P	227	009007-22M	222	50NF-48TX	146
001103-B	208	004105	227	009008-01F	222	50ZIP-10N	152
001103-BC1	208	005101	216	009008-01M	222	50ZIP-12N	152
001103-C	208	005102	216	009008-04F	222	50ZIP-17N	152
001103-D	208	005103	216	009008-04M	222	50ZIP-23N	152
001103-D1	208	005106	216	009008-05F	222	50ZIP-29N	152
001103-E	208	005112	216	009008-05M	222	50ZIP-36N	152
001103-E1	208	005116	216	009008-09F	222	50ZIP-48N	152
001103-F	208	005118	216	009008-09M	222	5000-07N	142
001103-I	208	005120	216	009011-B	220	5000-07T	147
001103-P	208	005121	216	009012-B	224	5000-10N	142
001103-S	208	005123	216	009018	223	5000-10T	147
0022F204	207	005127	216	009018-1	223	5000-12N	142
0022F255	207	005130	216	009018K	223	5000-12T	147
0022F325	207	005131	216	009100	221	5000-14N	142
0022F405	207	005132	216	009101	225	5000-17LN	142
0022M162	207	005134	216	4HTB2S2C1Y1	133	5000-17N	143
0022M204	207	005136	216	4HTB2S2Z1Y1	133	5000-17T	147
0022M255	207	005138	216	4HTB4S2C1Y1	133	5000-23LN	142
0022M325	207	005143	216	4HTB4S2Z1Y1	133	5000-23N	143
0022M405	207	005144	216	4HTB4S4C1Y1	133	5000-23T	147
002250	207	005147	216	4HTB4S4Z1Y1	133	5000-29LN	142
002452-1634	214	005161SC-B	219	4HTC2S2C1Y1	133	5000-29N	143
002452-3416	214	005205SC-B	219	4HTC2S2Z1Y1	133	5000-29T	147
002452C	212	005258	216	4HTC2Y1C1Y1	133	5000-36LN	142
002452N	212	005285	216	4HTC2Y1Z1Y1	133	5000-36N	143
002454ISO	213	005303	216	4HTC4S4C1Y1	133	5000-36T	147
002455N	212	005377SC-B	219	4HTC4S4Z1Y1	133	5000-48LN	142
002456N	213, 227	005456SC-B	219	4HTC4Y1C1Y1	133	5000-48N	143
003M162	213, 217	007001	215	4HTC4Y1Z1Y1	133	5000-48T	147
003M204	213, 217	007002	215	4HTD1S4C1Y1	134, 135	5001-07FN	158
003M254	213, 217	007003	215	4HTD2S4C1Y1	134	5001-07N	155
003M325	213, 217	007004	215	4HTD2S4Z1Y1	135	5001-07PN	156
003M405	217	007005	215	4HTE1S4C1Y1	134, 135	5001-07TX	157
003M505	217	007006	215	4HTE2S6C1Y1	134, 135	5001-10FN	158
003M635	217	007007	215	5HTF1Y2C1Y1	134, 135	5001-10N	155
003001	213, 217	007008	215	5HTF2Y2C1Y1	134, 135	5001-10PN	156
003002	212, 217	007009	215	50DUO-07N	153	5001-10TX	157

Indice codici

Code index

5001-12FN	158	5010-0709N	169	5012-0712N	168	5012M-2932NM	170
5001-12N	155	5010-0709N67	169	5012-0712N67	168	5012M-2940NM	170
5001-12PN	156	5010-0711N	169	5012-1012N	168	5012M-3640NM	170
5001-12TX	157	5010-0711N67	169	5012-1012N67	168	5012M-3650NM	170
5001-14N	155	5010-0713N	169	5012-1016N	168	5012M-4850NM	170
5001-17FN	158	5010-0713N67	169	5012-1016N67	168	5012M-4863NM	170
5001-17N	155	5010-1007N	169	5012-1216N	168	5012M-07125NM	170
5001-17PN	156	5010-1007N67	169	5012-1216N67	168	5012M-10125NM	170
5001-17TX	157	5010-1009M	171	5012-1220N	168	5012M-10165NM	170
5001-23FN	158	5010-1009N	169	5012-1220N67	168	5012M-12165NM	170
5001-23N	155	5010-1009N67	169	5012-1420N	168	5012M-12206NM	170
5001-23PN	156	5010-1011N	169	5012-1420N67	168	5012M-17206NM	170
5001-23TX	157	5010-1011N67	169	5012-1720N	168	5012M-17257NM	170
5001-29FN	158	5010-1013N	169	5012-1720N67	168	5012M-23257NM	170
5001-29N	155	5010-1013N67	169	5012-1725N	168	5012M-23327NM	170
5001-29PN	156	5010-1211M	171	5012-1725N67	168	5012M-29328NM	170
5001-29TX	157	5010-1211N	169	5012-1732N	168	5012M-29408NM	170
5001-36FN	158	5010-1211N67	169	5012-1732N67	168	5012M-36408NM	170
5001-36N	155	5010-1213N	169	5012-2325N	168	5012M-36509NM	170
5001-36PN	156	5010-1213N67	169	5012-2325N67	168	5012M-48509NM	170
5001-36TX	157	5010-1216N	169	5012-2332N	168	5012M-48630NM	170
5001-48FN	158	5010-1216N67	169	5012-2332N67	168	5013-07014N	169
5001-48N	155	5010-1413M	171	5012-2932N	168	5013-10014N	169
5001-48PN	156	5010-1413N	169	5012-2932N67	168	5013-10038N	169
5001-48TX	157	5010-1413N67	169	5012-2940N	168	5013-12012N	169
5002-07N	148	5010-1416N67	169	5012-2940N67	168	5013-12038N	169
5002-10N	148	5010-1713N	169	5012-3640N	168	5013-21012N	169
5002-12N	148	5010-1713N67	169	5012-3640N67	168	5013-22034N	169
5002-14N	148	5010-1716M	171	5012-3650N	168	5013-28001N	169
5002-17N	148	5010-1716N	169	5012-3650N67	168	5013-36112N	169
5002-23N	148	5010-1716N67	169	5012-4850N	168	5013-36114N	169
5002-29N	148	5010-2316N	169	5012-4850N67	168	5013-48002N	169
5002-36N	148	5010-2316N67	169	5012-4863N	168	5013-48112N	169
5002-48N	148	5010-2321M	171	5012-4863N67	168	5014K70	184
5004-70N	154	5010-2321N	169	5012DUO-1216N	191	5014K100	184
5004-100N	154	5010-2321N67	169	5012DUO-1220N	191	5014K7068	184
5006-07N	159	5010-2929M	171	5012DUO-1720N	191	5014K10068	184
5006-10N	159	5010-2929N	169	5012DUO-1725N	191	5014N70	184
5006-12N	159	5010-2929N67	169	5012DUO-2325N	191	5014N100	184
5006-17N	159	5010-3636M	171	5012DUO-2332N	191	5018-0707N67	197
5006-23N	159	5010-3636N	169	5012DUO-2932N	191	5018-1009N67	197
5006-29N	159	5010-3636N67	169	5012DUO-2940N	191	5018-1211N67	197
5006-36N	159	5010-4848M	171	5012DUO-3640N	191	5018-1213N67	197
5006-48N	159	5010-4848N	169	5012DUO-3650N	191	5018-1413N67	197
5008-07N	149	5010-4848N67	169	5012DUO-4850N	191	5018-1713N67	197
5008-10N	149	5011-07014N	168	5012DUO-4863N	191	5018-1716N67	197
5008-12N	149	5011-10012N	168	5012L-0712N	185	5018-2321N67	197
5008-12TX	150	5011-10012N67	168	5012L-1016N	185	5018-2929N67	197
5008-14N	149	5011-10014N	168	5012L-1220N	185	5018-3636N67	197
5008-14TX	150	5011-10014N67	168	5012L-1420N	185	5018-4848N67	197
5008-17LN	149	5011-10038N	168	5012L-1425N	185	5018M-0707NE*	199
5008-17TX	150	5011-10038N67	168	5012L-1720N	185	5018M-0707NM	198
5008-23LN	149	5011-12012N	168	5012L-1725N	185	5018M-0712N67	197
5008-23TX	150	5011-12012N67	168	5012L-2325N	185	5018M-0712NE	199
5008-29LN	149	5011-12038N	168	5012L-2332N	185	5018M-0712NM	198
5008-29TX	150	5011-12038N67	168	5012L-2932N	185	5018M-1009NE	199
5008-36LN	149	5011-17012N	168	5012L-2940N	185	5018M-1009NM	198
5008-36TX	150	5011-17012N67	168	5012L-3640N	185	5018M-1016N67	197
5008-48LN	149	5011-23034N	168	5012L-3650N	185	5018M-1016NE	199
5008-48TX	150	5011-23034N67	168	5012L-4850N	185	5018M-1016NM	198
5008L14N	151	5011-29001N	168	5012L-4863N	185	5018M-1211NE	199
5008L17LN	151	5011-29001N67	168	5012M-0712NM	170	5018M-1216N67	197
5008L23LN	151	5011-36114N	168	5012M-1012NM	170	5018M-1220N67	197
5008L29LN	151	5011-36114N67	168	5012M-1016NM	170	5018M-1220NE	199
5008L29N	151	5011-48002N	168	5012M-1216NM	170	5018M-1220NM	198
5008L36N	151	5011-48002N67	168	5012M-1220NM	170	5018M-1420N67	197
5008L48N	151	5011-48112N	168	5012M-1720NM	170	5018M-1716NE	199
5010-0707M	171	5011-48112N67	168	5012M-1725NM	170	5018M-1716NM	198
5010-0707N	169	5012-0710N	168	5012M-2325NM	170	5018M-1720NE	199
5010-0707N67	169	5012-0710N67	168	5012M-2332NM	170	5018M-1720NM	198

Indice codici

Code index

5018M-1725N67	197	5022-2332N	180	5028-1720NM	182	5029-2929N	176
5018M-1725NE	199	5022-2332N67	180	5028-1725N	179	5029-2929NM	177
5018M-1725NM	198	5022-2932N	180	5028-1725NM	182	5029-2929NMG	178
5018M-2321NE	199	5022-2932N67	180	5028-2321N	179	5029-2932N	176
5018M-2321NM	198	5022-2940N	180	5028-2321NM	182	5029-2932NM	177
5018M-2325NE	199	5022-2940N67	180	5028-2325N	179	5029-2932NMG	178
5018M-2325NM	198	5022-3640N	180	5028-2325NM	182	5029-2940N	176
5018M-2332N67	197	5022-3640N67	180	5028-2332N	179	5029-2940NM	177
5018M-2332NM	198	5022-3650N	180	5028-2332NM	182	5029-3636N	176
5018M-2929NE	199	5022-3650N67	180	5028-2929N	179	5029-3636NM	177
5018M-2929NM	198	5022-4850N	180	5028-2929NM	182	5029-3636NMG	178
5018M-2932NE	199	5022-4850N67	180	5028-2932N	179	5029-3640N	176
5018M-2932NM	198	5022-4863N	180	5028-2932NM	182	5029-3640NM	177
5018M-2940N67	197	5022-4863N67	180	5028-2940N	179	5029-3640NMG	178
5018M-2940NM	198	5023-07014N	181	5028-2940NM	182	5029-3650N	176
5018M-3636NE	199	5023-10014N	181	5028-3636N	179	5029-3650NM	177
5018M-3636NM	198	5023-12012N	181	5028-3636NM	182	5029-4848N	176
5018M-3640NE	199	5023-12038N	181	5028-3640N	179	5029-4848NM	177
5018M-3640NM	198	5023-21012N	181	5028-3640NM	182	5029-4850N	176
5018M-3650N67	197	5023-22034N	181	5028-3650N	179	5029-4850NM	177
5018M-3650NM	198	5023-28001N	181	5028-3650NM	182	5029-4863N	176
5018M-4848NE	199	5023-36112N	181	5028-4848N	179	5029-4863NM	177
5018M-4848NM	198	5023-36114N	181	5028-4848NM	182	5029L-1016N	185
5018M-4850NE	199	5023-48002N	181	5028-4850N	179	5029L-1220N	185
5018M-4850NM	198	5023-48112N	181	5028-4850NM	182	5029L-1420N	185
5018M-4863N67	197	5024N70	184	5028-4863N	179	5029L-1425N	185
5018M-4863NM	198	5024N100	184	5028-4863NM	182	5029L-1720N	185
5020-0707N	180	5025-101010N	189	5028M-0712N	179	5029L-1725N	185
5020-0707N67	180	5025-101013NPA	189	5028M-1016N	179	5029L-2325N	185
5020-1009N	180	5025-131313NPA	189	5028M-1220N	179	5029L-2332N	185
5020-1009N67	180	5025-131316NPA	189	5028M-1720N	179	5029L-2932N	185
5020-1011N67	180	5025-161616NPA	189	5028M-1725N	179	5029L-2940N	185
5020-1013N67	180	5025-161621N	189	5028M-2325N	179	5029L-3640N	185
5020-1211N	180	5025-161621NPA	189	5028M-2332N	179	5029L-3650N	185
5020-1211N67	180	5025-161628N	189	5028M-2932N	179	5029L-4850N	185
5020-1413N	180	5025-181818N	189	5028M-2940N	179	5029L-4863N	185
5020-1413N67	180	5025-212121N	189	5028M-3640N	179	5029M-0712N	176
5020-1716N	180	5025-212128N	189	5028M-3650N	179	5029M-1016N	176
5020-1716N67	180	5025-212128NPA	189	5028M-4850N	179	5029M-1220N	176
5020-2321N	180	5025-282834N	189	5028M-4863N	179	5029M-1720N	176
5020-2321N67	180	5025-282834NPA	189	5029-0707N	176	5029M-1725N	176
5020-2929N	180	5025-343442N	189	5029-0707NM	177	5029M-2325N	176
5020-2929N67	180	5025-343442NPA	189	5029-0712N	176	5029M-2332N	176
5020-3636N	180	5025-424254N	189	5029-0712NM	177	5029M-2932N	176
5020-3636N67	180	5025-424254NPA	189	5029-1009N	176	5029M-2940N	176
5020-4848N	180	5027-23N67	183	5029-1009NM	177	5029M-3640N	176
5020-4848N67	180	5027-29N67	183	5029-1016N	176	5029M-3650N	176
5021-10012N67	181	5027-36N67	183	5029-1016NM	177	5029M-4850N	176
5021-12012N67	181	5027-48N67	183	5029-1211N	176	5029M-4863N	176
5021-17012N67	181	5027-M25N	183	5029-1211NM	177	5030-07N	190
5021-23034N67	181	5027-M32N	183	5029-1220N	176	5030-10N	190
5021-29001N67	181	5027-M40N	183	5029-1220NM	177	5030-12N	190
5021-36114N67	181	5027-M50N	183	5029-1413N	176	5030-13N	190
5021-48002N67	181	5028-0707N	179	5029-1413NM	177	5030-17N	190
5022-0710N	180	5028-0707NM	182	5029-1716N	176	5030-17NPA	190
5022-0710N67	180	5028-0712N	179	5029-1716NM	177	5030-23N	190
5022-0712N	180	5028-0712NM	182	5029-1716NMG	178	5030-23NPA	190
5022-0712N67	180	5028-1009N	179	5029-1720N	176	5030-29N	190
5022-1016N	180	5028-1009NM	182	5029-1720NM	177	5030-29NPA	190
5022-1016N67	180	5028-1016N	179	5029-1720NMG	178	5030-36N	190
5022-1216N	180	5028-1016NM	182	5029-1725N	176	5030-36NPA	190
5022-1216N67	180	5028-1211N	179	5029-1725NM	177	5030-48N	190
5022-1220N	180	5028-1211NM	182	5029-2321N	176	5030-48NPA	190
5022-1220N67	180	5028-1220N	179	5029-2321NM	177	5030-1312N	190
5022-1720N	180	5028-1220NM	182	5029-2321NMG	178	5031-0717N	186
5022-1720N67	180	5028-1413N	179	5029-2325N	176	5031-0723N	186
5022-1725N	180	5028-1413NM	182	5029-2325NM	177	5031-1012N	186
5022-1725N67	180	5028-1716N	179	5029-2325NMG	178	5031-1017N	186
5022-2325N	180	5028-1716NM	182	5029-2332N	176	5031-1217N	186
5022-2325N67	180	5028-1720N	179	5029-2332NM	177	5031-1223N	186

Indice codici

Code index

5031-1229N	186	5048TPE-363034N	196	5097-17N	187	5112-3640N67	172
5031-1723N	186	5048TPE-483438N	196	5097-23N	187	5112-4850N67	172
5031-1729N	186	5048TPE-483842N	196	5097-29N	187	5112-4863N67	172
5031-1748N	186	5048TPE-484246N	196	5097-36N	187	5112-07125N67	172
5031-2329N	186	5048R-3612N	196	5097-48N	187	5112-10125N	172
5031-2936N	186	5048R-3617N	196	5100-10001228N8	174	5112-10125N67	172
5031-3648N	186	5048R-3623N	196	5100-10003420N8	174	5112M-0712NM	173
5033-070707N	188	5048R-3629N	196	5100-10005824N8	174	5112M-1016NM	173
5033-101010N	188	5048V-1M6X	195	5100-12000120N8	174	5112M-1220NM	173
5033-121212N	188	5048V-1M6Z	195	5100-12003420N8	174	5112M-1720NM	173
5033-121212NPA	188	5048V-1M8Z	195	5100-12005824N8	174	5112M-1725NM	173
5033-122323N	188	5048V-2M6X	195	5100-12111624N8	174	5112M-2325NM	173
5033-141414N	188	5048V-2M6Z	195	5100-12151620N8	174	5112M-2332NM	173
5033-171717N	188	5048V-2M8Z	195	5100-17000120N8	174	5112M-2932NM	173
5033-171717NPA	188	5048V-3M6Z	195	5100-17003420N8	174	5112M-2940NM	173
5033-231717N	188	5048V-3M8Z	195	5100-17005824N8	174	5112M-3640NM	173
5033-232323N	188	5049-17N	196	5100-17007820N8	174	5112M-3650NM	173
5033-232323NPA	188	5049-23N	196	5100-17011820N8	174	5112M-4850NM	173
5033-292323NPA	188	5049-29N	196	5100-17013418N8	174	5112M-4863NM	173
5033-292929N	188	5049-36N	196	5100-17013818N8	174	60GCU-08	162
5033-292929NPA	188	5049-48N	196	5100-17091624N8	174	60GCU-13	162
5033-363636NPA	188	5050-07N	187	5100-17131618N8	174	60GCU-17	162
5033-484848NPA	188	5050-10N	187	5100-17151620N8	174	60GCU-25	162
5043-07N	192	5050-12N	187	5100-17171618N8	174	60GCU-40	162
5043-10N	192	5050-14N	187	5100-23000120N8	174	60GCU-55	162
5043-10N	192	5050-17N	187	5100-23013418N8	174	60GCUK-08	162
5043-12N	192	5050-23N	187	5100-23013818N8	174	60GCUK-13	162
5043-14N	192	5050-29N	187	5100-23131618N8	174	60GCUK-17	162
5043-17N	192	5050-36N	187	5100-23151620N8	174	60GCUK-25	162
5043-23N	192	5050-48N	187	5100-23171618N8	174	60GCUK-40	162
5043-29N	192	5052-07N	186	5100-29000120N8	174	60GCUK-55	162
5043-36N	192	5052-10N	186	5100-29000218N8	174	60GEDU-08	161
5043-48N	192	5052-12N	186	5100-29013418N8	174	60GEDU-13	161
5044-07N	194	5052-17N	186	5100-29013818N8	174	60GEDU-17	161
5044-10N	194	5052-23N	186	5100-29015818N8	174	60GEDU-25	161
5044-12N	194	5052-29N	186	5100-29131618N8	174	60GEDU-40	161
5044-14N	194	5052-36N	186	5100-29171618N8	174	60GEDU-55	161
5044-17N	194	5052-1012N	186	5100-36000218N8	174	60GPA-10	160
5044-23N	194	5052-1216N	186	5100-36013418N8	174	60GPA-14	160
5044-29N	194	5052-1720N	186	5100-36021416N8	174	60GPA-22	160
5044-36N	194	5052-2325N	186	5100-36131618N8	174	60GPA-27	160
5044-48N	194	5052-4850N	186	5100-36171618N8	174	60GPA-34	160
5044-63N	194	5058-07	203	5100-48021416N8	174	60GPA-42	160
5045C-07G	193	5058-10	203	5110-0707NM	173	60GPA-80	160
5045C-07N	193	5058-12	203	5110-1009N67	172	60GPET-08G	160
5045C-10N	193	5058-17	203	5110-1009NM	173	60GPET-08N	160
5045C-12N	193	5058-23	203	5110-1211N67	172	60GPET-11G	160
5045C-14N	193	5058-29	203	5110-1211NM	173	60GPET-11N	160
5045C-17N	193	5058-36	203	5110-1413NM	173	60GPET-14G	160
5045C-23N	193	5058-48	203	5110-1716N67	172	60GPET-14N	160
5045C-29N	193	5061-070838N	175	5110-1716NM	173	60GPET-20G	160
5045C-36N	193	5061-070853N	175	5110-2321N67	172	60GPET-20N	160
5045C-48N	193	5061-071238N	175	5110-2321NM	173	60GPET-25G	160
5047N	193	5061-071253N	175	5110-2929N67	172	60GPET-25N	160
5048-12SN	195	5061-071853N	175	5110-2929NM	173	60GPET-30G	160
5048-17N	195	5061-073053N	175	5110-3636N67	172	60GPET-30N	160
5048-17SN	195	5061-100865N	175	5110-3636NM	173	60GPET-38G	160
5048-23N	195	5061-101265N	175	5110-4848N67	172	60GPET-38N	160
5048-23SN	195	5061-101865N	175	5110-4848NM	173	60GPET-50G	160
5048-29N	195	5061-103065N	175	5112-1016N	172	60GPET-50N	160
5048-36N	195	5062-070846N	175	5112-1016N67	172	60GPET-60G	160
5048-48N	195	5062-070860N	175	5112-1216N	172	60GPET-60N	160
5048-362N	195	5062-071246N	175	5112-1216N67	172	60GPET-80G	160
5048-363N	195	5062-071260N	175	5112-1720N	172	60GPET-80N	160
5048TPE-120710N	196	5062-071860N	175	5112-1720N67	172	60HT-10	48
5048TPE-171014N	196	5062-073060N	175	5112-2325N	172	60HT-12	48
5048TPE-231418N	196	5097-07N	187	5112-2325N67	172	60HT-15	48
5048TPE-361822N	196	5097-10N	187	5112-2932N	172	60HT-20	48
5048TPE-362226N	196	5097-12N	187	5112-2932N67	172	60HT-25	48
5048TPE-362630N	196	5097-14N	187	5112-3640N	172	60HT-30	48

■ Indice codici

Code index

60HT-35	48	607D-22	31	607PU38N	34	667DXXM40	44
60HT-38	48	607D-22N	31	607PU40N	34	667DXXM50	44
60HT-40	48	607D-32	31	607PU50N	34	667M1013	41
60HT-42	48	607D-32N	31	607T-10	45	667M1215	41
60HT-42	48	607D-38	31	607T-12	45	667M1518	41
60HT-45	48	607D-38N	31	607T-16	45	667M2024	41
60HT-51	48	607D-40	31	607T-20	45	667M2630	41
60HT-60	48	607D-40N	31	607T-27	45	667M3539	41
60HT-65	48	607D-50	31	607T-35	45	667M4044	41
60HT-70	48	607D-50N	31	607T-40	45	667M5054	41
60HT-75	48	607D-63	31	607T-50	45	6003-1	107
60HT-80	48	607D-63N	31	607X-12	46	6003-03	107
60HT-85	48	607D-75	31	607X-16	46	6003-04	107
60HT-90	48	607D-75N	31	607X-22	46	6003-12	107
60HT-100	48	607D-100	31	607X-32	46	6003-16	107
60HT-115	48	607D-100N	31	607X-38	46	6003-16A	107
66BOTT10	74	607DBT22	35	607XX-12	47	6003-20	107
66BOTT12	74	607DBT32	35	607XX-16	47	6003-25	107
66BOTT16	74	607DBT38	35	607XX-22	47	6003-32A	107
66BOTT20	74	607DBT40	35	607XX-32	47	6003-34	107
66BOTT32	74	607DBT50	35	607XX-38	47	6003-40	107
66BOTT38	74	607DBT63	35	633B-01	120	6003-50	107
66BOTT40	74	607DX-10	32	633B-02	120	6003-60	107
66BOTT50	74	607DX-12	32	633B-03	120	6003-63	107
66BTP10	74	607DX-16	32	633B-04	120	6003-112	107
66BTP12	74	607DX-22	32	633B-12	120	6003-114	107
66BTP16	74	607DX-32	32	633B-34	120	6003-212	107
66BTP22	74	607DX-38	32	633B-112	120	6004-16	103
66BTP32	74	607DX-40	32	633B-114	120	6004-21	103
66BTP38	74	607DX-50	32	633B-212	120	6004-112	103
66BTP40	74	607DXX-10	33	640F-0B4S2C1X1	136	6004-134	103
66BTP50	74	607DXX-12	33	640F-0B4S4C1X1	136	6004-138	103
603B-01	119	607DXX-16	33	640F-0D2S4C1X1	136	6004-0234	103
603B-02	119	607DXX-22	33	640F-0E2S6C1X1	136	6004-0412	103
603B-03	119	607DXX-32	33	640X-0B4S2C1X1	136	6004-0434	103
603B-04	119	607DXX-38	33	640X-0B4S4C1X1	136	6004-0438	103
603B-34	119	607DXX-40	33	640X-0D2S4C1X1	136	6004-1112	103
603B-112	119	607DXX-50	33	640X-0E2S6C1X1	136	6004-1114	103
603B-114	119	607E010	30	653S00	123	6004-1121	103
603B-212	119	607E010N	30	653S01	123	6004-1141	103
603D-01	119	607E010R	30	653S02	123	6004-1201	103
603D-02	119	607E012	30	653S03	123	6004-1204	103
603D-03	119	607E012N	30	653S04	123	6004-1214	103
603D-04	119	607E012R	30	653S05	123	6004-1234	103
603D-12	119	607E016	30	653S06	123	6004-1412	103
603D-34	119	607E016N	30	667DM10	42	6004-2112	103
603D-112	119	607E016R	30	667DM12	42	6004-2114	103
603D-114	119	607E022	30	667DM15	42	6004-3401	103
603D-212	119	607E022N	30	667DM20	42	6004-3412	103
603S-01	119	607E032	30	667DM26	42	6004-3438	103
603S-02	119	607E032N	30	667DM35	42	6004-3804	103
603S-03	119	607E038	30	667DM40	42	6004-3812	103
603S-04	119	607E038N	30	667DM50	42	6004-3834	103
603S-12	119	607E040	30	667DM63	42	6004-11202	103
603S-34	119	607E040N	30	667DM75	42	6004-11212	103
603S-112	119	607E050	30	667DM100	42	6004-11234	103
603S-114	119	607E050N	30	667DXM10	43	6004-11238	103
603S-212	119	607ETX010	40	667DXM12	43	6004-11412	103
603V-01	121	607ETX012	40	667DXM15	43	6004-11434	103
603V-02	121	607ETX016	40	667DXM20	43	6004-11438	103
603V-12	121	607ETX022	40	667DXM26	43	6004-11438	103
603V-34	121	607ETX032	40	667DXM35	43	6006-1	110
603V-112	121	607ETX038	40	667DXM40	43	6006-03	110
603V-212	121	607ETX040	40	667DXM50	43	6006-04	110
607D-10	31	607ETX050	40	667DXXM10	44	6006-07	110
607D-10N	31	607PU10N	34	667DXXM12	44	6006-09	110
607D-12	31	607PU12N	34	667DXXM15	44	6006-11	110
607D-12N	31	607PU16N	34	667DXXM20	44	6006-12	110
607D-16	31	607PU22N	34	667DXXM26	44	6006-13	110
607D-16N	31	607PU32N	34	667DXXM35	44	6006-14	110

■ Indice codici

Code index

6006-15	110	6006-N29	202	6013-25XX	88	6014-50I7	57
6006-16	110	6006-N29N	202	6013-32L	88	6014-50IG	59
6006-16A	110	6006N-32B	202	6013-32X	88	6014-50NG	59
6006-16XX	111	6006N-32N	202	6013-32XX	88	6014-50NPT	57
6006-20	110	6006N-34B	202	6013-40	88	6014-65	57
6006-20XX	111	6006N-34N	202	6013-40X	88	6014-65G	59
6006-21	110	6006-N36	202	6013-40XX	88	6014-65I7	57
6006-25	110	6006-N36N	202	6013-50	88	6014-65IG	59
6006-25XX	111	6006N-38B	202	6013-50X	88	6014-65NG	59
6006-29	110	6006N-38N	202	6013-50XX	88	6014-65NPT	57
6006-32A	110	6006N-40B	202	6013-63	88	6014-75	57
6006-32XX	111	6006N-40N	202	6013-63X	88	6014-75G	59
6006-34	110	6006-N42	202	6013-63XX	88	6014-75I7	57
6006-36	110	6006-N42N	202	6014-07	56	6014-75IG	59
6006-40	110	6006-N48	202	6014-09G	58	6014-75NG	59
6006-40XX	111	6006-N48N	202	6014-10	57	6014-75NPT	57
6006-42	110	6006N-50B	202	6014-10G	59	6014-100	57
6006-48	110	6006N-50N	202	6014-11G	58	6014-100G	59
6006-50	110	6006N-63B	202	6014-12	57	6014-100I7	57
6006-50XX	111	6006N-63N	202	6014-12G	59	6014-100IG	59
6006-60	110	6006N-112B	202	6014-13G	58	6014-100NPT	57
6006-63	110	6006N-112N	202	6014-15G	58	6014-381	57
6006-63XX	111	6006N-114B	202	6014-16	57	6014-1009G	58
6006-75XX	111	6006N-114N	202	6014-16A	56	6014-1016	56
6006-90XX	111	6008-16L3	76	6014-16G	59	6014-1016G	58
6006-112	110	6008-16L4	76	6014-16I7	57	6014-1038	57
6006-114	110	6008-16P3	77	6014-16IG	59	6014-1038G	59
6006-212	110	6008-20L3	76	6014-16NG	59	6014-1212	57
6006DUO-16N	191	6008-20L4	76	6014-16NPT	57	6014-1212G	59
6006DUO-20N	191	6008-20P3	77	6014-20A	56	6014-1213G	58
6006DUO-25N	191	6008-25L3	76	6014-20G	58	6014-1216G	58
6006DUO-32N	191	6008-25L4	76	6014-21G	58	6014-1616	56
6006DUO-40N	191	6008-25P3	77	6014-22	57	6014-2020	56
6006DUO-50N	191	6008-32L3	76	6014-22G	59	6014-2527	56
6006DUO-63N	191	6008-32L4	76	6014-22I7	57	6014-2732G	58
6006E-12	111	6008-32P3	77	6014-22IG	59	6014-4035	56
6006E-16	111	6008-40L3	76	6014-22NG	59	6014-4035G	58
6006E-20	111	6008-40L4	76	6014-22NPT	57	6014-5040	56
6006E-25	111	6008-40P3	77	6014-25A	56	6014-5040G	58
6006E-32	111	6008-50L3	76	6014-25G	58	6014-6350	56
6006E-40	111	6008-50L4	76	6014-29G	58	6014-6350G	58
6006E-50	111	6008-50P3	77	6014-32	57	6014P10M120509	63
6006E-63	111	6008-63L3	76	6014-32A	56	6014P10M160509	63
6006EMC-16A	111	6008-75L3	76	6014-32G	59	6014P10M200812	63
6006N-01B	202	6010EMCFP1311	163	6014-32I7	57	6014P12M120509	63
6006N-01N	202	6010EMCFP2116	163	6014-32IG	59	6014P12M160509	63
6006N-02B	202	6012EMCFP3225	163	6014-32NG	59	6014P12M200812	63
6006N-02N	202	6012EMCFP3232	163	6014-32NPT	57	6014P16M120509	63
6006-N07	202	6012EMCFP4032	163	6014-36	56	6014P16M160509	63
6006-N07N	202	6012EMCFP5040	163	6014-36G	58	6014P16M200812	63
6006-N09	202	6012EMCFP6363	163	6014-38	57	6014P16M251116	63
6006-N09N	202	6012PAT-1216	165	6014-38G	59	6014P22M200812	63
6006-N11	202	6012PAT-1216G	165	6014-38I7	57	6014P22M201116	63
6006-N11N	202	6012PAT-1720	165	6014-38IG	59	6014P22M251116	63
6006N-12B	202	6012PAT-1720G	165	6014-38NG	59	6014P22M321521	63
6006N-12N	202	6012PAT-2325	165	6014-38NPT	57	6014P32M201116	63
6006-N13	202	6012PAT-2325G	165	6014-40	57	6014P32M251116	63
6006-N13N	202	6012PAT-2932	165	6014-40A	56	6014P32M251521	63
6006N-14B	202	6012PAT-2932G	165	6014-40G	59	6014P32M321521	63
6006N-14N	202	6012PAT-3640	165	6014-40I7	57	6014P32M402027	63
6006-N15	202	6012PAT-3640G	165	6014-40IG	59	6014P38M321521	63
6006-N15N	202	6012PAT-4850	165	6014-40NG	59	6014P38M402027	63
6006N-16B	202	6012PAT-4850G	165	6014-40NPT	57	6014P40M402027	63
6006N-16N	202	6013-16L	88	6014-42	56	6014XX16	61
6006N-20B	202	6013-16X	88	6014-42G	58	6014XX16A	61
6006N-20N	202	6013-20L	88	6014-48	56	6014XX16G	61
6006-N21	202	6013-20X	88	6014-48G	58	6014XX20A	61
6006-N21N	202	6013-20XX	88	6014-50	57	6014XX20G	61
6006N-25B	202	6013-25L	88	6014-50A	56	6014XX25A	61
6006N-25N	202	6013-25X	88	6014-50G	59	6014XX32A	61

Indice codici

Code index

6014XX1616	61	6018-M1216	96	6019-3201	101	6040-114X	94
6014XX2020	61	6018-M1620	96	6019-3420	101	6040-212	94
6014XX4035	61	6018-M2025	96	6019-6302	101	6040-P01	94
6014XX5040	61	6018-M2532	96	6019-11240	101	6040-P02	94
6015-10	60	6018-M3240	96	6019-11432	101	6040-P03	94
6015-10A	60	6018-P07	200	6019-21263	101	6040-P04	94
6015-12	60	6018-P09	200	6024-1610	64	6040-P12	94
6015-12A	60	6018-P09C	201	6024-1612	64	6040-P34	94
6015-16	60	6018-P11	200	6024-1616	64	6040-P112	94
6015-16A	60	6018-P11C	201	6024-2016	64	6040-P114	94
6015-20	60	6018-P12	200	6024-2020	64	6040-P212	94
6015-25	60	6018-P13	200	6024-2520	64	6040-X16	93
6015-32A	60	6018-P13C	201	6024-2527	64	6042-16	93
6015-40	60	6018-P15	200	6024-3227	64	6042-20	93
6015-50	60	6018-P15C	201	6025-1610	65	6042-25	93
6015-2020	60	6018-P16	200	6025-1612	65	6042-32	93
6015-2527	60	6018-P16C	201	6025-1616	65	6042-40	93
6015-3235	60	6018-P20	200	6025-2016	65	6042-50	93
6015-4035	60	6018-P20C	201	6025-2020	65	6042-63	93
6015-5040	60	6018-P21	200	6025-2520	65	6044-A16	92
6015-6350	60	6018-P21C	201	6025-2527	65	6044-A20	92
6016-1620	100	6018-P25	200	6025-3227	65	6044-A25	92
6016-2016	100	6018-P25C	201	6028-16	108	6044-A32	92
6016-2025	100	6018-P29	200	6028-20	108	6044-A40	92
6016-2520	100	6018-P29C	201	6028-20G	109, 171	6044-A50	92
6016-2532	100	6018-P32	200	6028-25	108	6050-1	106
6016-3220	100	6018-P32C	201	6028-25G	109, 171	6050-12	106
6016-3225	100	6018-P36	200	6028-32	108	6050-16	106
6016-3240	100	6018-P36C	201	6028-32G	109, 171	6050-16A	106
6016-4020	100	6018-P40	200	6028-40G	109, 171	6050-20	106
6016-4025	100	6018-P42	200	6028-50G	109, 171	6050-25	106
6016-4032	100	6018-P42C	201	6028-63G	109, 171	6050-32A	106
6016-4050	100	6018-P48	200	6029-16	108	6050-34	106
6016-5032	100	6018-P48C	201	6029-20	108	6050-40	106
6016-5040	100	6018-P50	200	6029-25	108	6050-50	106
6016-5063	100	6018-P63	200	6029-32	108	6050-63	106
6016-6340	100	6018X-M08	98	6030-1	118	6050-114	106
6016-6350	100	6018X-M10	98	6030-2	118	6051-1	106
6018-01	95	6018X-M12	98	6030-03	118	6051-12	106
6018-02	95	6018X-M16	98	6030-4	118	6051-16	106
6018-07	95	6018X-M20	98	6030-16A	118	6051-16A	106
6018-09	95	6018X-M25	98	6030-20	118	6051-20	106
6018-11	95	6018X-M32	98	6030-25	118	6051-25	106
6018-12	95	6018X-M40	98	6030-32A	118	6051-32A	106
6018-12A	95	6018X-M50	98	6030-40	118	6051-34	106
6018-13	95	6018X-M63	98	6030-50	118	6051-40	106
6018-14	95	6018X-M081	98	6030-112	118	6051-50	106
6018-15	95	6018X-M101	98	6030-114	118	6051-60	106
6018-16	95	6018X-M121	98	6030-212	118	6051-63	106
6018-20	95	6018X-M123	98	6030E12	118	6051-112	106
6018-21	95	6018XX-M16	99	6030-E34	118	6051-114	106
6018-25	95	6018XX-M20	99	6040-001	94	6052-16A	89
6018-29	95	6018XX-M25	99	6040-001X	94	6052-20	89
6018-32	95	6018XX-M32	99	6040-002	94	6052-25	89
6018-34	95	6018XX-M40	99	6040-003	94	6052-32A	89
6018-36	95	6018XX-M1216	99	6040-004	94	6052-40	89
6018-38	95	6018XX-M1620	99	6040-012	94	6052-50	89
6018-40	95	6018XX-M2025	99	6040-012X	94	6054-0111	102
6018-42	95	6018XX-M2532	99	6040-16	93	6054-0113	102
6018-48	95	6018XX-M3240	99	6040-22	93	6054-0116	102
6018-50	95	6019-0120	101	6040-25	93	6054-0121	102
6018-63	95	6019-0125	101	6040-32	93	6054-0129	102
6018-112	95	6019-0132	101	6040-034	94	6054-0409	102
6018-114	95	6019-0250	101	6040-034X	94	6054-0411	102
6018-M16A	96	6019-0263	101	6040-38	93	6054-0413	102
6018-M20	96	6019-1216	101	6040-50	93	6054-0704	105
6018-M25	96	6019-1638	101	6040-60	93	6054-0738	105
6018-M32	96	6019-2012	101	6040-112	94	6054-0904	105
6018-M40	96	6019-2534	101	6040-112X	94	6054-0912	105
6018-M50	96	6019-2538	101	6040-114	94	6054-0938	105

■ Indice codici

Code index

6054-1104	105	6058-28	75	6060R2834	112	6071ET-016	38
6054-1112	105	6058-35	75	6060R3238	112	6071ET-022	38
6054-1138	105	6058-40	75	6060R3341	112	6071ET-032	38
6054-1209	102	6059-10	73	6060R3743	112	6071ET-038	38
6054-1211	102	6059-12	73	6060R4050	112	6071ET-040	38
6054-1213	102	6059-12T	73	6060R4250	112	6071ET-050	38
6054-1216	102	6059-15	73	6060R4756	112	6071ETX-010	39
6054-1221	102	6059-15T	73	6060R4855	112	6071ETX-012	39
6054-1304	105	6059-20	73	6060R5060	112	6071ETX-016	39
6054-1312	105	6059-28	73	6060R6070	112	6071ETX-022	39
6054-1334	105	6059-28T	73	6060R6373	112	6071ETX-032	39
6054-1338	105	6059-36	73	6060X-12	47	6071ETX-038	39
6054-1604	105	6059-36T	73	6060X-16	47	6071ETX-040	39
6054-1612	105	6059-40	73	6060X-22	47	6071ETX-050	39
6054-1634	105	6059-40T	73	6060X-32	47	6071PU-10N	28
6054-1638	105	6059-47	73	6060X-38	47	6071PU-12N	28
6054-2101	105	6059-58	73	6070-10	29	6071PU-15N	28
6054-2112	105	6060-03	113	6070-10N	29	6071PU-20N	28
6054-2134	105	6060-04	113	6070-10R	29	6071PU-27N	28
6054-2138	105	6060-212	113	6070-12	29	6071PU-35N	28
6054-2901	105	6060-1319	113	6070-16	29	6071PU-40N	28
6054-2934	105	6060-1522	113	6070-12N	29	6071PU-50N	28
6054-3411	102	6060-1722	113	6070-12R	29	6071T-010	36
6054-3413	102	6060-1925	113	6070-16	29	6071T-012	36
6054-3416	102	6060-2127	113	6070-16N	29	6071T-016	36
6054-3421	102	6060-2228	113	6070-16R	29	6071T-022	36
6054-3429	102	6060-2532	113	6070-22	29	6071T-032	36
6054-3809	102	6060-2632	113	6070-22N	29	6071T-038	36
6054-3811	102	6060-2834	113	6070-32	29	6071T-040	36
6054-3813	102	6060-3238	113	6070-32N	29	6071T-050	36
6054-3816	102	6060-3340	113	6070-38	29	6071TX010	37
6054-11236	102	6060-3742	113	6070-38N	29	6071TX012	37
6054-11421	102	6060-4050	113	6070-40	29	6071TX016	37
6054-11436	102	6060-4249	113	6070-40N	29	6071TX022	37
6054-29114	105	6060-4956	113	6070-50	29	6071TX032	37
6054-36112	105	6060-5060	113	6070-50N	29	6071TX038	37
6054-36114	105	6060-6070	113	6071-010	26	6071TX040	37
6054-42112	105	6060-6472	113	6071-010N	26	6071TX050	37
6054-42114	105	6060F1220	112	6071-012	26	6079-10B	52
6057-10	73	6060F1417	112	6071-012N	26	6079-50B	52
6057-12	73	6060F1623	112	6071-015	26	6080-10B	51
6057-15	73	6060F1823	112	6071-015N	26	6080-10N	51
6057-20	73	6060F2029	112	6071-020	26	6080-12B	51
6057-28	73	6060F2127	112	6071-020N	26	6080-12N	51
6057-35	73	6060F2537	112	6071-027	26	6080-16B	51
6057-40	73	6060F2834	112	6071-027N	26	6080-16N	51
6057-121	73	6060F3244	112	6071-035	26	6080-20B	51
6057-201	73	6060F3340	112	6071-035N	26	6080-20N	51
6057-281	73	6060F3742	112	6071-040	26	6080-25B	51
6057-1009	72	6060F4052	112	6071-040N	26	6080-25N	51
6057-1012	72	6060F4251	112	6071-050	26	6080-32B	51
6057-1016	72	6060F4855	112	6071-050N	26	6080-32N	51
6057-1211	72	6060F5064	112	6071E-010	27	6080-40B	51
6057-1213	72	6060F6166	112	6071E-010N	27	6080-40N	51
6057-1216	72	6060F6368	112	6071E-012	27	6080-50B	51
6057-1513	72	6060PA1622	113	6071E-012N	27	6080-50N	51
6057-1520	72	6060PA2026	113	6071E-015	27	6085-10	49
6057-2013	72	6060PA2532	113	6071E-015N	27	6085-10A	49
6057-2016	72	6060PA3239	113	6071E-020	27	6085-12	49
6057-2020	72	6060PA4048	113	6071E-020N	27	6085-12A	49
6057-2025	72	6060PA5060	113	6071E-027	27	6085-15	49
6057-2725	72	6060R1318	112	6071E-027N	27	6085-15A	49
6057-2732	72	6060R1622	112	6071E-035	27	6085-20	49
6057-2821	72	6060R1724	112	6071E-035N	27	6085-20A	49
6057-3529	72	6060R1924	112	6071E-040	27	6085-27	49
6057-3632	72	6060R2026	112	6071E-040N	27	6085-27A	49
6058-10	75	6060R2127	112	6071E-050	27	6085-36	49
6058-12	75	6060R2330	112	6071E-050N	27	6085-36A	49
6058-15	75	6060R2532	112	6071ET-010	38	6085-40	49
6058-20	75	6060R2632	112	6071ET-012	38	6085-40A	49

Indice codici

Code index

6089-10	50	6111-32N	82	6117-4035	84	6188-1516N	71
6089-12	50	6111-32XX	86	6117-5040	84	6188-1520N	70
6089-15	50	6111-40	82	6117PAT-1720	165	6188-2021B	71
6089-20	50	6111-40XX	86	6117PAT-2325	165	6188-2021G	71
6089-28	50	6111-50	82	6117PAT-2932	165	6188-2021N	71
6089-35	50	6111-50XX	86	6117PAT-3640	165	6188-2025N	70
6089-40	50	6111-63XX	86	6117PAT-4850	165	6188-2529B	71
6097L16B	88	6111-A16N	82	6117XX20N	87	6188-2529N	71
6097L20B	88	6111-A20N	82	6117XX25N	87	6188-2532N	70
6097L25B	88	6111-A25N	82	6117XX32N	87	6188-2732B	70
6097L32B	88	6111-A32N	82	6117XX63N	87	6188-2732G	70
6097L40B	88	6111-A40	82	6117XX4035	87	6188-3229B	71
6097L50B	88	6111-A50	82	6117XX5040	87	6188-3229N	71
6097L63B	88	6111-A63N	82	6118-16M	97	6188-3240N	70
6104-0709	104	6111P16M120509	85	6118-20M	97	6188-3536G	71
6104-0907	104	6111P16M160509	85	6118-25M	97	6188-3536N	71
6104-0911	104	6111P16M200812	85	6118-32M	97	6188-4036B	71
6104-0913	104	6111P20M160812	85	6118-40M	97	6188-4036G	71
6104-1107	104	6111P20M200812	85	6118-1216M	97	6188-4036N	71
6104-1109	104	6111P20M251116	85	6118-1620M	97	6188-4050N	70
6104-1113	104	6111P25M201116	85	6118-2025M	97	6188-5048	71
6104-1116	104	6111P25M251116	85	6118-2532M	97	6188-5048B	71
6104-1309	104	6111P25M321521	85	6118-3240M	97	6188-5048G	71
6104-1311	104	6111P32M251521	85	6188-10B	71	6188-5063N	70
6104-1316	104	6111P32M321521	85	6188-10G	71	6190	93
6104-1321	104	6111P32M402027	85	6188-12B	71	6191	93
6104-1607	104	6111P40M322027	85	6188-12G	71	6252-1640	115
6104-1609	104	6111P40M402027	85	6188-12N	71	6252-C	114
6104-1611	104	6112-16N	83	6188-15B	71	6252C16	114
6104-1613	104	6112-16XX	87	6188-15G	71	6252C20	114
6104-1621	104	6112-20N	83	6188-15N	71	6252C25	114
6104-2113	104	6112-20XX	87	6188-20B	71	6252C32	114
6104-2116	104	6112-25N	83	6188-20G	71	6252C40	114
6104-2129	104	6112-25XX	87	6188-20N	71	6252C50	114
6104-2921	104	6112-32N	83	6188-27G	71	6252M16	114
6104-2936	104	6112-32XX	87	6188-27N	71	6252M20	114
6104-3629	104	6112-40	83	6188-32B	71	6252M25	114
6104-4236	104	6112-40XX	87	6188-32N	71	6252M32	114
6104-4248	104	6112-50	83	6188-35G	71	6252M40	114
6104-4842	104	6112-50XX	87	6188-35N	71	6252M50	114
6105-1609	101	6112-63XX	87	6188-40B	71	6253-1640	115
6105-1611	101	6112-A16	83	6188-40G	71	6255	115
6105-2011	101	6112-A20	83	6188-40N	71	6330-1	120
6105-2013	101	6112-A25	83	6188-50B	71	6330-2	120
6105-2516	101	6112-A32	83	6188-50G	71	6330-3	120
6105-3221	101	6112-A40	83	6188-50N	71	6330-4	120
6105-4029	101	6112-A50	83	6188-101B	71	6330-16A	120
6105-5036	101	6112-A63N	83	6188-101G	71	6330-20	120
6105-6348	101	6115-01	60	6188-101N	71	6330-25	120
6110-16N	82	6115-02	60	6188-251B	71	6330-32A	120
6110-16XX	86	6115-03	60	6188-251N	71	6330-34	120
6110-20N	82	6115-04	60	6188-1009B	71	6330-40	120
6110-20XX	86	6115-12	60	6188-1009G	71	6330-50	120
6110-25N	82	6115-34	60	6188-1009N	71	6330-112	120
6110-25XX	86	6115-112	60	6188-1011B	71	6330-114	120
6110-32N	82	6115-114	60	6188-1011G	71	6330-212	120
6110-32XX	86	6115-212	60	6188-1011N	71	6330-E12	120
6110-40	82	6117-10N	84	6188-1012B	70	6330-E34	120
6110-40XX	86	6117-12N	84	6188-1211B	71	6400SP025	126
6110-50	82	6117-16N	84	6188-1211G	71	6410E01	126
6110-50XX	86	6117-20N	84	6188-1211N	71	6410E02	26
6110-63N	82	6117-25N	84	6188-1213B	71	6410E03	126
6110-63XX	86	6117-32N	84	6188-1213G	71	6410E04	126
6110-75	82	6117-40	84	6188-1213N	71	6410P02	126, 127
6111-16N	82	6117-50	84	6188-1216N	70	6410P03	126, 127
6111-16XX	86	6117-63N	84	6188-1513B	71	6410P04	126, 127
6111-20N	82	6117-75	84	6188-1513G	71	6410P06	126, 127
6111-20XX	86	6117-2020	84	6188-1513N	71	6410P09	126, 127
6111-25N	82	6117-2527	84	6188-1516B	71	6410P10	126, 127
6111-25XX	86	6117-3235	84	6188-1516G	71	6410P12	126, 127

■ Indice codici

Code index

6410P16	126, 127	653021	124	UNIKO32X	91
6410P20	126, 127	653021H	124	UNIKO32XX	91
6410P25	126, 127	653022	124	UNIKO40	91
6410P40	126	653022H	124	UNIKO40X	91
6410P43	126	653023	124	UNIKO40XX	91
6410S06	126	653023H	124	UNIKO50	91
6410S06-S	126	653024	124	UNIKO50X	91
6410S09	126	653024H	124	UNIKO50XX	91
6410S10-S	126	653025	124		
6410S12	126	653025H	124	X	
6410S12-S	126	653026	124	XX3310	218
6410S16	126	653026H	124	XX3317	218
6410S16-S	126	66950074A	122 - 125	XX3318	218
6410S20	126	6700-16L4	78	XX3319	218
6410S20-S	126	6700-20L4	78	XX3320	218
6410S25	126	6700-25L4	78	XX3321	218
6410S25-S	126	6700-32L4	78	XX3322	218
6410S40-S	126	6700-40L4	78	XX3323	218
6410S43	126	6700-50L4	78	XX3325	218
6411S06	127	6700-63L4	78	XX3326	218
6411S09	127	6700A16L3	79	XX3328	218
6411S12	127	6700A20L3	79	XX3330	218
6411S16	127	6700A25L3	79	XX3332	218
6430-1	121	6700A32L3	79	XX3338	218
6430-2	121	6700A40L3	79	XX3340	218
6430-3	121	6700A50L3	79	XX3348	218
6430-4	121	6700A63L3	79	XX3350	218
6430-12	121			XX3352	218
6430-16	121			XX3360	218
6430-16A	121	P		XX3370	218
6430-20	121	PA360A	131	XX3380	218
6430-25	121	PA360AC2	131	XX3390	218
6430-34	121	PA360B	131	XX33155	218
6430-40	121	PA360B2F	131	XX33225	218
6430-50	121	PA360B2FC2	131	XXPT11	218
6430-112	121	PA360BC2	131	XXPT16	218
6430-114	121	PA360KAIF	132	XXPT22	218
6430-212	121	PA360KIF	132	XXPT27	218
6430-E12	121	PA360PS	132	XXPT27L1	218
6430-E34	121	PA360PS45	132	XXPT27L2	218
653S00	123	PA360PSS	132	XXPT221	218
653S01	123	PA360PSS45	132	XXPT222	218
653S02	123	PA3602B	131	XXPT271	218
653S03	123	PA3602B2F	131	XXPT272	218
653S04	123	PA3602B2FC2	131		
653S05	123	PA3602BC2	131		
653S06	123				
65300	122	S			
65300N	125	S66V10	75		
65301	122	S66V12	75		
65302	122	S66V16	75		
65303	122	S66V22	75		
65304	122	S66V32	75		
65305	122	S66V38	75		
65306	122	S66V40	75		
65310	125	S66V50	75		
65311	125	S0433000010	203		
65312	125	S0433000011	203		
65313	125	S0433001011	203		
65314	125				
65315	125	U			
65316	125	UNIKO16	91		
65317	125	UNIKO16X	91		
653011	124	UNIKO16XX	91		
653012	124	UNIKO20	91		
653013	124	UNIKO20X	91		
653014	124	UNIKO20XX	91		
653015	124	UNIKO25	91		
653016	124	UNIKO25X	91		
653020	124	UNIKO25XX	91		
		UNIKO32	91		

DKC Europe srl

Il presente catalogo è parte integrante del patrimonio DKC Europe. Imitazioni e riproduzioni, anche parziali, sono vietate salvo nostra autorizzazione. DKC Europe si riserva il diritto di modificare le caratteristiche e /o le dimensioni dei prodotti illustrati nel presente catalogo, in qualsiasi momento e senza obbligo di preavviso. Le misure riportate dei prodotti e/o componenti sono fornite a titolo informativo e pertanto non vincolanti essendo possibile la loro modifica senza preavviso.

DKC Europe srl

This catalogue is an integral part of DKC's Europe heritage. Any reproduction, performance or imitation thereof, even partial, is therefore prohibited without the prior written consent from DKC Europe and the companies of the DKC Group that own the said trademarks. DKC Europe reserves the right to change specifications and/or dimensions of the products shown in this catalogue, at any time and without notice.

The measures reported on products and/or components are provided for information purposes only and are therefore non-binding as they may be modified without prior notice.

■ Italy

DKC Europe Srl
Bellinzago Novarese (NO)
Novi Ligure (AL)
Villanova sull'Arda (PC)
Roma (RM)
Collegno (TO)
Ph. +39 0321 989898

DKC Power Solutions srl
Brivio (LC)
Lograto (BS)
Ph. +39 0321 9898750

■ Hungary

DKC Hungary Kft
Budapest
Ph. +36 74540002

■ Ukraine

DKC Ukraine
Kiev
Ph. +380 (044) 496-18-45

■ Romania

DKC Romania
Jud. Arad
Ph. +40 257278187

■ Tunisia

DKC Maghreb sarl
Tunis
Ph. +216 71409778

■ Russia

DKC Russia
Tver
Ph. +7 (4822) 777-980

Commercial office
Moscow
Ph. +7 (495) 916-5262

Branches
Voronezh
Ekaterinburg
Kazan
Krasnodar
Krasnoyarsk
Nizhny Novgorod
Novosibirsk
Perm
Rostov-on-Don
Samara
St. Petersburg
Ufa
Khabarovsk
Chelyabinsk
Cheboksary
Vladivostok
Tula
Tyumen
Saratov
Archangelsk
Irkutsk
Volgograd

■ Brazil

Beghim Indústria e Comércio Ltda
São Paulo
Ph. +55 11 2942-4500

Maxtil Industria e Comercio Ltda
Recife
Ph. +55 81 3339-6653

■ China

DKC Kitai
Shangai
Ph. +39 0321 98 98 944
+39 0321 98 98 706

■ Middle East

DKC Middle East
Ph. +966 547832604
+7 915 385 39 65
+39 0321 98 98 944
+39 0321 98 98 706

